

The Dock Doctors LLC

Waterfront Specialists



2025 Stock Catalog

Readily available docks, stairs, and accessories



Docks & Boat Lifts



Aluminum Stairs



Dock Accessories



Paddle Products

Table of Contents

DOCKS (pre-manufactured)

Swim Rafts (floating rafts).....	4-5
Pond Docks (floating docks for ponds).....	6-7
Aluminum Leg & Wheel Docks	24-35
Galvanized Steel Truss Leg & Wheel Docks	36-47
Aluminum Floating Docks.....	48-53

OPTIONS & ACCESSORIES

Decking Choices.....	8-9
Vertical Fenders.....	10-11
Edge Fender, Mooring Whips, Storage Racks	12-13
Boat and Paddle Craft Access.....	14-15
Solar Lights, Flagpoles, Decorative Options.....	16-17
Dock Adjustment Tools.....	18
Ladders & Shallow Water Stairs.....	19

ALUMINUM STAIRS

Aluminum Stair Kits.....	20-23
--------------------------	-------

PADDLE PRODUCTS

Paddle Docks	54-55
Rowing Docks.....	56-57
Paddle Craft Launch Docks & Lifts	58-63
Kayak, Canoe, SUP Storage Racks	64-67

BOAT LIFTS

PWC lifts	68
Boat Access & Seasonal Service Tools.....	69
Aluminum Vertical Cable Lifts & Accessories.....	70-73
Hydraulic Cantilever Lifts & Accessories	74-75
Dock Doctors Ultimate Boat Lifts	76-79
Boathouse & Specialty Lifts, Custom Canopies	80

DOCKS Leg, Wheel and Floating Docks readily available for pickup, delivery or installation.



DOCK OPTIONS & ACCESSORIES

ALUMINUM STAIRS



BOAT LIFTS & CANOPIES

FREE CURBSIDE DELIVERY* (p. 3)



SWIM RAFTS & POND DOCKS



PADDLE PRODUCTS



INSTALLATION SERVICES (p. 81)



Dock Doctors Design Services:

Our experienced staff will create a FREE dock layout and estimate designed to your specific site and individual needs.



Please see our CUSTOM catalog for our custom designed and manufactured products

View and download our catalogs at: www.thedockdoctors.com/catalogs

The Dock Doctors[®]

Waterfront Specialists



Manufacturing Facility & Vermont Year-Round Showroom



Warehouse & Distribution

Factory Direct

from our door to yours

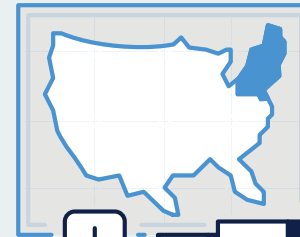

Local delivery & installation available throughout the Northeast

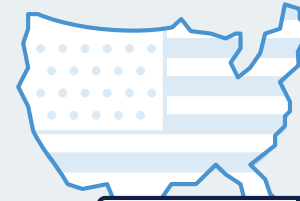

*Nationwide Shipping
USPS, UPS & Freight*

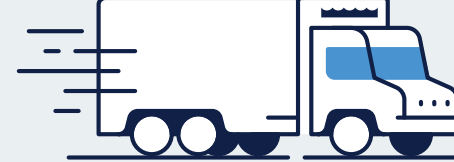

800-870-6756

www.thedockdoctors.com

info@thedockdoctors.com

Pricing Disclaimer – Printed pricing throughout this catalog and our website are subject to change due to the fluctuation of raw materials, fuel and other manufacturing costs.



Look for the truck for products that qualify for free delivery* or pickup & save**!



Free Delivery*

our trucks deliver curbside* to your site

Minimum Purchase <i>not including sales tax</i>	Free Delivery <i>from Ferrisburgh, VT</i>	Delivery Charge <i>over the free mile range</i>
\$2,000	25 miles	\$4 / mile*
\$4,000	50 miles	\$4 / mile*
\$6,000	100 miles	\$4 / mile*
\$8,000	150 miles	\$4 / mile**
\$10,000	200 miles	\$4 / mile**

OR

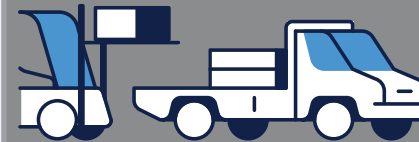

Pick Up & Save**

we will pay you to pickup!

Minimum Purchase <i>not including sales tax</i>	Pickup Discount <i>based on minimum purchase amount</i>
\$2,000	\$75.00**
\$4,000	\$150.00**
\$6,000	\$300.00**
\$8,000	\$450.00**
\$10,000	\$600.00**

*** Free Curbside Delivery Terms & Conditions:** 1. Curbside delivery definition: We will back up as close as we can with our vehicle to your installation site and off-load your product. We cannot carry your product further than the side/rear of our truck/trailer. Our delivery vehicles cannot go off of approved driveway surfaces (ie on grass, etc.). 2. Free delivery available on The Dock Doctors® Stock Products only. Please see chart above for minimum purchase amounts to qualify for free delivery. Free delivery does not apply to Rowing or Paddle Docks or Ultimate Boat Lifts. 3. Boat Lifts, canopies & accessories – free delivery applies to products in stock only. 4. If you want your product installed, please inquire on rates for this service – free delivery does not apply. 5. Additional fees apply for wide loads (assembled boat lifts) & ferry charges, if needed. 6. Purchases under \$2,000 are subject to a \$4.00 per mile one way charge from Ferrisburgh, VT. A ground shipping method/charge by another source such as Common Carrier or UPS may be more feasible depending on product purchased. 7. † Due to regulations for hourly driving restrictions by the Federal Motor Carrier there may be an additional fee applicable to deliveries 200 miles or over for overnight charges. 8. Large loads may require assistance on site to off-load. **** Pickup & Save Conditions:** 1. Applies to pickup at our Ferrisburgh, Vermont warehouse, arranged by the customer. 2. Available on The Dock Doctors® Stock Products only. Please see chart above right for minimum purchase amounts to qualify for pickup and save. Does not apply to Rowing or Paddle Docks or Ultimate Boat Lifts. 3. Boat Lifts, canopies & accessories – pickup and save applies to products in stock only.

Swim Rafts : Aluminum & Galvanized Steel Frame Floating Rafts



8' x 8' aluminum swim raft with cedar decking and aluminum ladder.

Aluminum Swim Raft (shown above)

Ideal for use in small lakes or calm bays. One piece lightweight aluminum frame with polyethylene floats. Removable decking panels. Optional ladder and anchoring sold separately.

Stock Size	Weight*	CEDAR		WEARDECK™	
		Net Buoyancy	Price	Net Buoyancy	Price
8' x 8'	162 lbs.	865 lbs.	\$2,275	787 lbs.	\$2,665

*Weights do not include the decking. See page 3 for details on Free Delivery or Pickup and Save. See decking details and color choices on page 8-9. Custom size swim rafts available, please contact us for details.



Aluminum Swim Raft

Ideal for calm bays or small bodies of water

- Lightweight one-piece aluminum frame
- Removable decking panels
- Stocked in 8' x 8' size



8' x 8' Aluminum Swim Raft
with removable deck panels shown with 3' ladder

Aluminum Ladder (see page 19)

3 foot: **\$305** 4 foot: **\$325** 5 foot: **\$345**

A Light Duty Float Harness

Includes shackles, swivel, 3' of 3/8" chain & (2) 10' nylon ropes. **\$130**

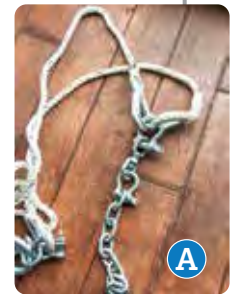

Nylon Rope Extension

Amount needed is 1.5 x the water depth. 8' (**\$58**), 10' (**\$60**), 14' (**\$62**), 18' (**\$64**), 22' (**\$66**)

B Concrete Anchor (Light Duty)

18" x 8", 180 lbs. **\$150**



For more info on anchoring, visit:

www.thedockdoctors.com/swim-float-anchoring



Heavy Duty Galvanized Steel Swim Raft

Heavy-duty, ideal for rough water

- Two-piece galvanized steel frame
- Removable decking panels
- Dismantles into two pieces for ease of handling



8' × 8' Galvanized Steel Swim Raft
with removable deck panels shown with 3' ladder

10' × 10' galvanized steel swim raft with WearDeck™ decking and aluminum ladder.

Galvanized Steel Swim Raft (shown above)

Ideal for rough water. Dismantles into two pieces for ease of handling. Removable decking panels. Optional ladder and anchoring sold separately.

Stock Size	Weight*	CEDAR		WEARDECK™	
		Net Buoyancy	Price	Net Buoyancy	Price
8' × 8'	238 lbs	789 lbs.	\$2,375	711 lbs	\$2,765
8' × 10'	248 lbs.	778 lbs.	\$2,660	638 lbs.	\$3,160
10' × 10'	476 lbs.	1,787 lbs.	\$3,600	1611 lbs.	\$4,230

*Weights do not include the decking. See page 3 for details on Free Delivery or Pickup and Save. See decking details and color choices on page 8-9. Custom size swim rafts available, please contact us for details. Ipe hardwood or other composite decking options available.



Aluminum Ladder (see page 19)

3 foot: **\$305** 4 foot: **\$325** 5 foot: **\$345**

Heavy Duty Float Harness

Includes shackles, swivel & (2) 10' nylon ropes. Chain sold separately. **\$195**

Galvanized Chain

Amount needed is 1.5 × the water depth.
\$4.95 / foot

Concrete Anchor (Heavy Duty)

2' × 2' × 8', 400 lbs. **\$180**



For more info on anchoring, visit:
www.thedockdoctors.com/swim-float-anchoring

Pond Docks : Floating docks for ponds with aluminum or galvanized steel frames

Available in a galvanized steel or aluminum frame, our pond docks feature removable decking panels in natural cedar or maintenance-free WearDeck™ composite.

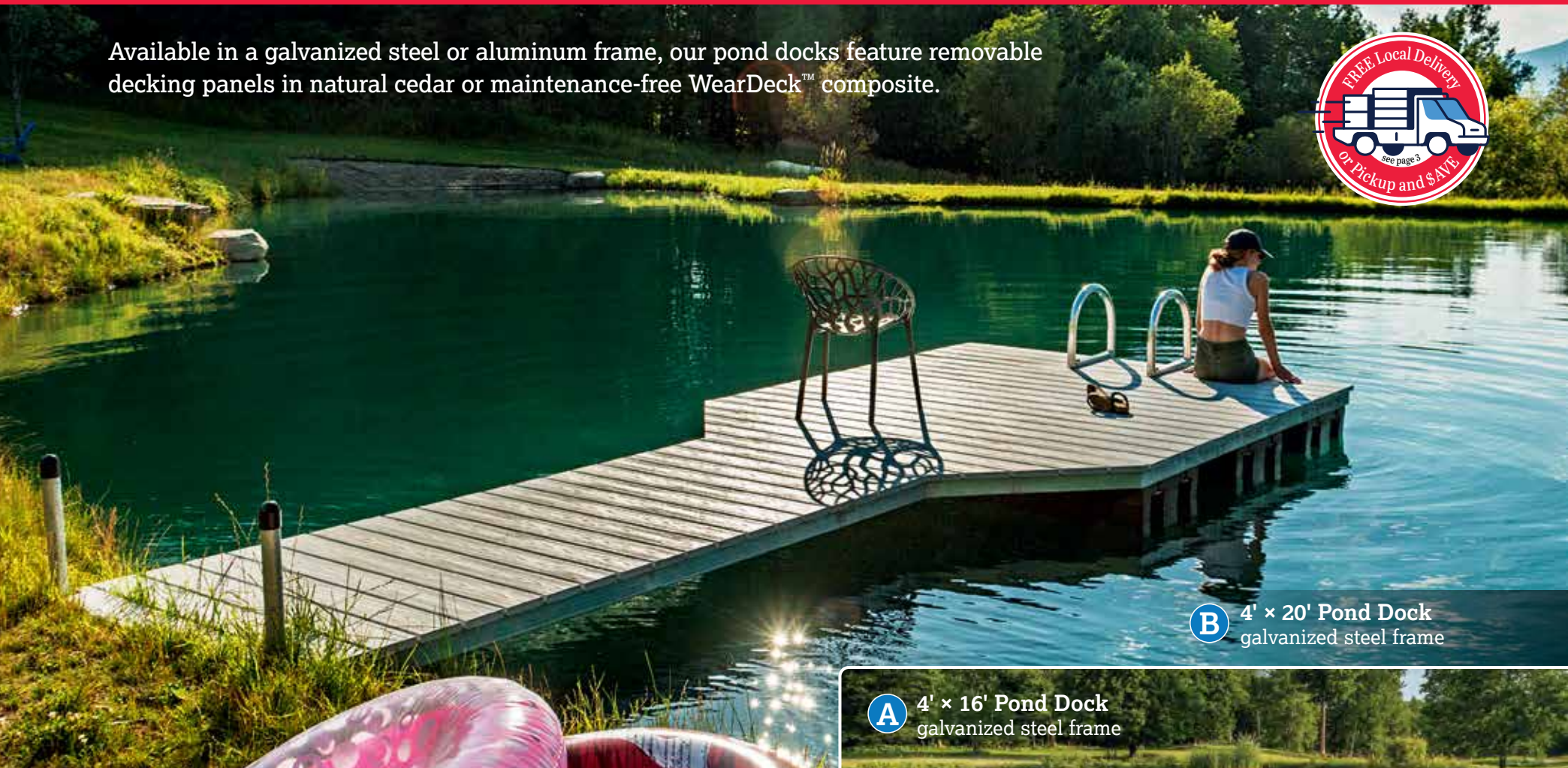

B 4' x 20' Pond Dock
galvanized steel frame

A 4' x 16' Pond Dock
galvanized steel frame



Designed for ponds or bodies of water with little to no wave activity or water level fluctuation.

Pond Docks

- Removable decking panels in Cedar or WearDeck™
- Galvanized steel frame pond dock available in 4' x 16' or 4' x 20' sizes
- 4-piece aluminum frame pond dock available in 4' x 18' size, designed to ship freight
- Optional aluminum ladder (see p. 19)

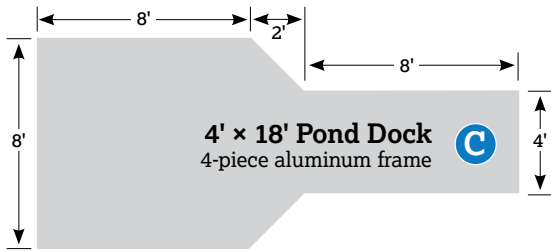
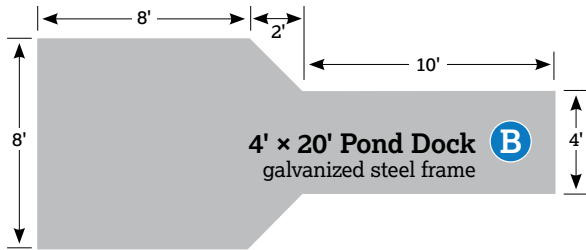
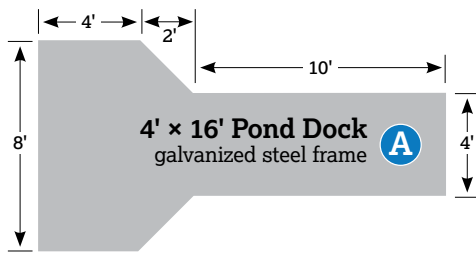

4' x 18' Aluminum Pond Dock
ships on a 4' x 10' pallet. Calculate shipping at:
thedockdoctors.com/pond-dock
or see page 3 for local delivery options



(C) 4' x 18' Pond Dock
4-piece aluminum frame

Pond Docks

All pond docks feature removable decking panels and black polyethylene floats. Includes (2) 3 ft. long 1-1/2" pipes with safety caps for shore anchoring.

Stock Size	Weight*
4' x 16' galvanized steel frame	289 lbs
4' x 20' galvanized steel frame	410 lbs
4' x 18' aluminum frame (4-piece)	322 lbs

*Weights do not include the decking. See page 3 for details on Free Delivery or Pickup and Save. See decking details and color choices on page 8-9. Ipe hardwood or other composite decking options available (4' x 20' pond dock only).

CEDAR	WEARDECK™
	
Price	Price
\$3,220	\$4,020
\$4,320	\$5,340
\$4,350	\$5,370

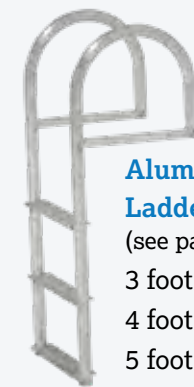

Aluminum Ladder
(see page 19):
3 foot: **\$305**
4 foot: **\$325**
5 foot: **\$345**

Options & Accessories : Decking Choices

Choosing the decking for your new dock system is an important choice, and there are many factors to consider, including maintenance, longevity, color, cost and personal style-preferences.



NATURAL CEDAR

Cedar is a natural decking option that is naturally resistant to decay and insects. We use STK Western Red Cedar (Select Tight Knot Grade or Number 2). It is generally regarded as a high-quality choice for cedar, and any knots present are sound encased and tight. The wood is generally straight-grained and has a uniform, but rather coarse texture.

CONS: Over time, cedar will absorb moisture and weather to a soft silvery gray unless sealed with a preserving stain.



ALUMINUM

Aluminum resists the growth of mold and mildew and won't rust, rot, split or stain. This painted then baked beige finish eliminates glare from the aluminum. The non-slip, rigid, surface is low-maintenance and cool to the touch. Color is Sherman Williams Beige.

CONS: Can sound metallic when walking on it, especially on our docks with removable panels.



SURE-STEP

Sure-Step is a slip-resistant, polypropylene surface that allows water and sunlight through to help conserve the underwater ecosystem. Preferred option for dock structures that are situated close to the water so waves will pass through the decking, adding minimal resistance. Color: Grey.

CONS: Only available in certain dimensions, so may not be a viable option for many applications.

Sure-Step is only available on our Standard Duty Aluminum Leg & Wheel Docks





WEARDECK™

WearDeck™ is a high density polyethylene resin with UV inhibitors. It is rated for ground and underwater contact and will not support mold or mildew growth. WearDeck's 5/4" thick deck board is rated to span joists 24" on center with the highest live load capacity in the industry. Made in the USA and offers a limited lifetime residential warranty and 25 year commercial warranty. Stocked in 3 colors, with special order colors available. CONS: Not a natural wood. **Barefoot Collection**  The colors of the Barefoot Collection (A) Barefoot Grey and (B) Barefoot Sand reflect the sun's rays off the surface of the board and reduce surface temperature by at least 30%.



STOCKED COLORS

(A) BAREFOOT GRAY

(B) BAREFOOT SAND

(C) WEATHERWOOD



SPECIAL ORDER COLORS please inquire for pricing and lead times

(D) WHITE

(E) CEDAR

(F) SADDLE

(G) GRAY

(H) SAND



IPE HARDWOOD

Ipe is extremely hard, very durable and naturally resistant to rot and insects. Ipe's strong, resilient properties make it an excellent material choice for marine applications. Please inquire for pricing and lead times.

CONS: Due to the density of Ipe, it is heavy and hard to drill and cut, therefore more labor intensive than working with other decking materials. It is also a natural wood, therefore there will be inconsistencies with regard to color, weathering and texture.



All our products are
proudly made in the USA

Options & Accessories : Vertical Fenders, Cleats

Protect your boat and dock with our adjustable vertical fenders (available for all dock systems). Our quality vertical fender material provides adequate cushion for protection — but is firm and slick enough to allow the boat gunnel to slide up and down without friction that could cause damage to seasonal docks.



Shipping Available

Our unique vertical fender design provides a double adjustment both on the fender mount and on the dock support pipe (see details on photo below) — which is often necessary due to lake level and boat style. Add a fender cleat kit (see **G** on p. 11) for a complete securing system for your boat.

up and down on the fender mount
1

up and down on the pipe
2

4' Vertical Fender with **A** 1-1/2" pipe mount and **G** fender cleat kit



Options & Accessories : Vertical Fenders, Cleats



Fender Style	Mounting Style	3' long	4' long
For all Aluminum Leg & Wheel Docks & Steel Truss Leg Docks with 1-1/2" pipe:			
A Fender	1-1/2" pipe mount	\$192	\$212
B Double Corner Fender	1-1/2" pipe mount	\$350	\$405
For all Steel Truss Wheel Docks with 1-1/2" pipe:			
C Fender with offset	1-1/2" pipe mount	\$200	\$220
For all Mega Leg Docks with 3" pipe or Custom Articulating Docks with 2" pipe:			
D Fender	2" or 3" pipe mount	\$240	\$260
For all Aluminum "Track-Frame" Floating Docks:			
E Fender	Track Mounted	\$215	\$235
For all Aluminum "Track-Frame" Floating Docks - includes spud mount:			
F Fender	Spud Anchor Mounted	\$ 455	\$ 475



G Fender Cleat Kit

Designed to be used with the 3' or 4' fenders shown on page 10. Includes (2) cleats per kit that bolt onto the fender mount.

\$49 per kit

includes 2 cleats and hardware to attach to vertical fender

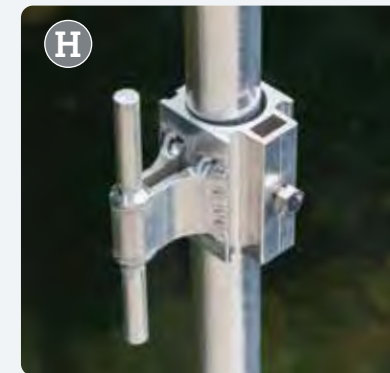

H Pipe Cleat *(for 1-1/2" pipe)*

A single cleat welded to a sleeve that slides over the leg pipe. Available for all leg & wheel docks except the mega leg & wheel docks.

\$45 each

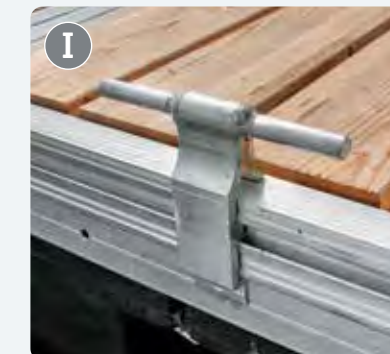

I Track Cleat

Designed to slide along the track of our floating aluminum track dock systems.

\$30 each

Options & Accessories : Edge Fender, Mooring Whips

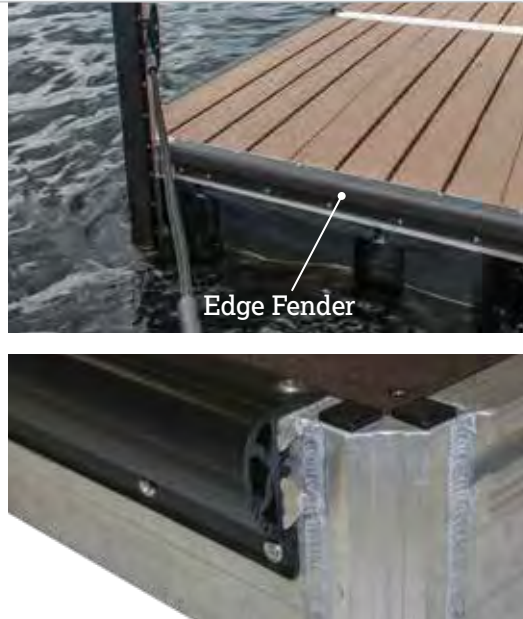
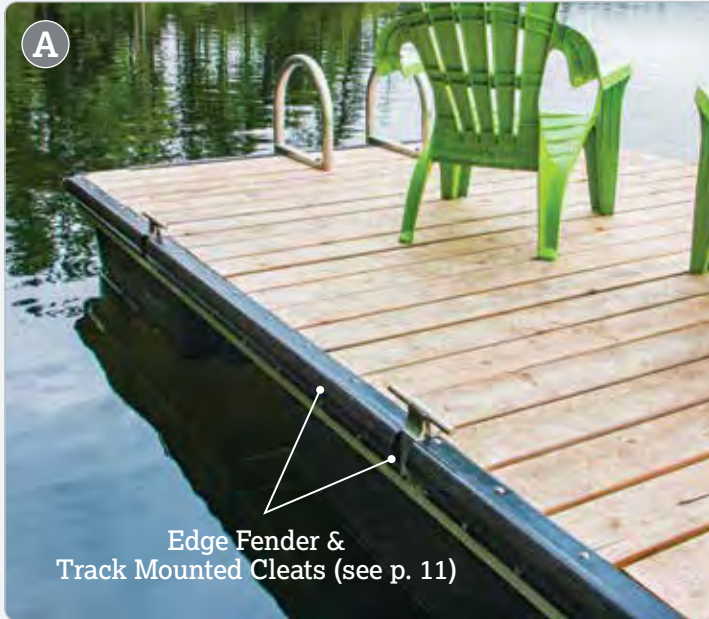

A Edge Fender

An alternative to our vertical fenders, this high quality, non-marring black edge fender can be installed on our Aluminum Leg and Wheel Docks (standard and medium duty), our Aluminum Floating Docks and our Custom Steel Truss Floating Docks.

\$9.95 per foot

(material only, not installed, not including fasteners)

\$14.00 per foot

(installed with stainless steel fasteners*)

NOTE: *installation available on new dock orders only



B Taylor Made Mooring Whips

Mooring whips with fixed angle base. Two-piece kit, will need to be epoxied (epoxy included with kit). Recommended for low profile boats such as bass boats, runabouts and sport boats.

MW120: \$715 for 18' – 23' boats / 2,500–5,000 lbs.

MW140: \$815 for 24' – 28' boats / 5,000–10,000 lbs.

Disclaimer: Some docking conditions may be too rugged for this product.

C Mooring Whip Dock Mounts (for Dock Doctors docks)

Required for docks with removable decking. **\$205**
(for Taylor Made mooring whip models listed above only)



Heavy Duty
and Mega Dock
Truss Frame
Mount



Aluminum
Track Frame
Mount



Dock Mounted Storage (kayak, canoe, paddleboard)

Marine-grade aluminum small craft storage. Arms feature vinyl hull guards and end caps with built-in tie-down openings. Crafts can be secured with a cable and lock (not included).



A Storage Arms (pair) (single craft, dock mounted)

A pair of storage arms which slide onto the leg pipes of your dock. Arms are 35" in length. Note: Fits all docks with 1-1/2" pipe*. **\$220**

*Designed for 1-1/2" SCH #40 pipe or any pipe that measures 1-15/16" O.D. (outside diameter)



B Storage Rack (2-craft, dock mounted)

Our 2-craft storage rack mounts to the frame of your dock and stores two crafts and paddles/oars. Top arm is 35", bottom arm is 18" (wider crafts can be stored at an angle). *Mounts available for all models of Dock Doctors docks, as well as a universal mount for wooden docks.* **\$680**



See our full line of Paddle Craft Products on pages 54-67



Options & Accessories : Boat & Paddle Craft Access



Lower Access Platform : for swimming & kayaking

Stationary leg docks are often quite a distance above the waters' surface, making accessing the water for swimming or kayaking very difficult. Our lower access platform is designed to provide you with a safe transition to the water. Designed to be used alongside any 8–10' long dock with 1-1/2" support pipes (including non-Dock Doctors docks). If the distance is too far to step from your dock to the platform, add one of our aluminum dock ladders to safely transition to the lower platform.

Lower Access Platform: \$975
optional ladder (see p. 19)

- 5" tall aluminum frame
- Sure-Step® flow-thru, anti-slip decking
- Designed to be used alongside any 8'–10' long dock with 1-1/2" support pipes
- Adjustable sleeves slide over 1-1/2" support pipes



Options & Accessories : Boat & Paddle Craft Access



Dock mounted roller and our lower access platform (shown on page 14)

Dock Mounted Roller

A single 12" keel roller designed to assist you when moving canoes, kayaks, or other small crafts on or off your dock. Universal mount can be mounted to the dock frame or dock decking. Track frame mount fits our Medium Duty Aluminum Floating Docks (pages 46-51). **\$145**

- A1** Universal Surface Mount
- A2** Track Frame Mount for Dock Doctors Aluminum Floating Docks



Boarding Handle

Our marine-grade aluminum boarding handle provides a safe handhold when boarding your boat. Mounts to Dock Doctors floating aluminum track dock systems or universal mount to attach to any dock frame. Height from mount to top of handle is 48".

Boarding Handle: \$135
(mount sold separately)

- A** Universal Mount: **\$90**
- B** Track Mount: **\$90**

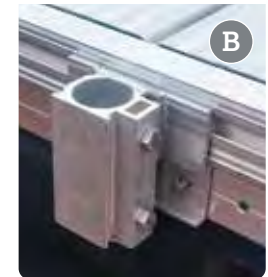
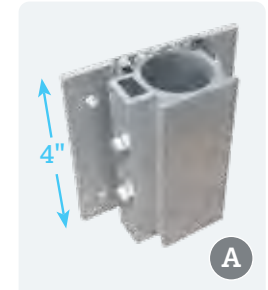

Track mount for Dock Doctors Aluminum Floating Docks shown on pages 48 - 55.



Sliding Boarding Step

Great for people and pets!

Our sliding boarding step easily slides and retracts so you can safely board your boat from your dock. Securely attaches to your existing dock. Includes a safety handrail that can mount to either side of platform. **\$1,155**

Visit our website for full details and specifications.

Options & Accessories : Solar Lights & Decorative Options



Solar Lighting options for your dock!
No Wiring Required and easy hassle free mounting.



Available with white LEDs only

Solar Dock Post Lites

Super bright LED (12 lumens) last 18+ hours on a full charge. Automatic night activation. Fits standard 1-1/2" and 2" pipes.

\$56.95
package of 2

- Fully sealed electronic circuit board
- Replaceable 1.2v NiMh battery
- Two (2) post lites in each package



Available with white LEDs only

1-3/8" Dock Dots

The smallest solar lights you have ever seen! Easy to install in minutes with a 1-3/8" drill bit or hole saw.

\$56.95
package of 4



Available with white LEDs only

Deck Lights

Industrial strength solar powered dock light. Marine grade anodized aluminum offers superior protection in harsh marine environments.

\$37.95
each



Solar Dock Post Lites last 18+ hours on a full charge.

Decorative Options for your dock



Wooden skirt-boards and cedar post covers are used to camouflage the steel truss frame and leg pipe, providing the appearance of a wooden dock system. Please inquire for pricing and details.

Options & Accessories : Flag Poles & Bird Deterrents

16' Aluminum Telescoping Flagpoles

Add beauty to your waterfront property with a telescoping flagpole. Each section of the pole raises and lowers easily, and with no ropes, chains or pulleys they are virtually noise-free. Includes a 3" gold aluminum ball ornament, a double flag harness to fly two flags or fly at half mast, a 3' x 5' nylon USA flag with embroidered stars and sewn stripes. Other pole heights available as special order.

Flagpoles: Silver Finish **\$369** Black Finish **\$399**

Flagpole Dock Mounts:

A Deck Surface Mount: **\$149** **B** Side Mount: **\$129** **C** Pole Mount*: **\$129**



*Pole mount for docks with 1-1/2" leg pipe

BIRD•B•GONE™ Sea Gull Eliminators

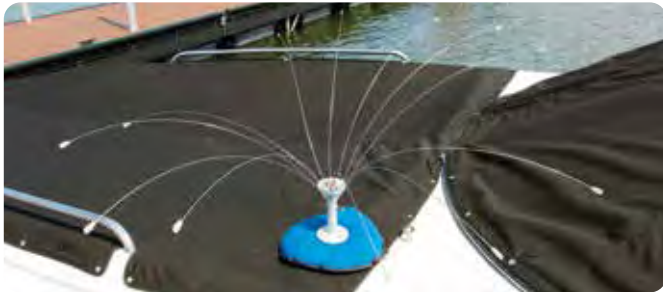

Bird Spider 360°

The spider's spinning motion is effective at deterring birds from landing on your boat, swim raft or dock. Stainless steel arms with scuff-preventing polycarbonate tips move with the breeze. Permanent glue-on base or use optional sandbag mount. **6' Diameter Spider \$44.99**



Sandbag Base

Attaches directly to either style repeller (hardware included). Eyelets around outer ring for extra security. Weighs 8 lbs.

Sandbag Base \$44.99

16' Aluminum Telescoping Flagpole shown here with black finish and pole mount



Options & Accessories : Dock Adjustment Tools & Boatlift Install/Removal Tools

Adjustment Kit

Adjust the level of your dock with this kit that slides over the 1-1/2" leg pipe. Available for all leg & wheel docks with 1-1/2" pipe. Sold as a pair (winch with sleeve and hook). **\$339 / pair**



Mega Dock Adjustment Kit

Adjust the level of your dock with this kit that slides over the 3" leg pipe. **\$589 / pair**



Spud Puller & Pounder Kit

This (2) piece system aids in the installation and removal of spud pole anchors for our floating dock systems.

2" puller/pounder kit: **\$345**

3" puller/pounder kit: **\$435**



Boat Lift Installation & Removal Tools

Make the seasonal installation and removal of your boat lift easier with a wheel kit and/or air bag lift system.

Boat Lift Wheel Kits

Specifically designed for use with RGC® boat lifts. Includes a pair of welded galvanized steel mounting brackets and a pair of heavy duty polyethylene wheels (*BLW5075 kit comes with 4 wheels).

BLW2045 (fits 2,000 – 4,500 lb. lifts): **\$430 / pair**

BLW5060 (fits 5,000 – 6,000 lb. lifts): **\$445 / pair**

BLW5075* (fits 5,000 – 8,000 lb. lifts): **\$610 / pair**



Air Bag Lift Kits / Boat lift Tubes

Inflatable 250 and 500 lb. capacity air bags designed to float your boat lift for seasonal installation and removal. Ideal when used in conjunction with a wheel kit (see photo on left).

A Enclosed Pillow Lift Bag:

250 lb. capacity: **\$360**

500 lb. capacity: **\$560**

B Boat Lift Tube:

500 lb. capacity: **\$685**

Each kit includes (1) lift bag or (1) tube with a connecting kit (carabiner and strap). Airbag inflates with air compressor with a standard 1/4" NPT air fitting (not included).

Options & Accessories : Ladders & Steps



Dock Ladders

(available for all dock systems)

One-piece, removable vertical ladder with 1-1/2" tubular aluminum frame and arched, slip resistant 4" treads for added comfort with bare feet. Treads are 17.5" wide.

Stock Size	Price
3' ladder	\$305
4' ladder	\$325
5' ladder	\$345

length is measured from the top of the dock down



Also suitable for accessing the shoreline from your dock.



Shallow Water Stairs

(available for all leg & wheel docks)

One-piece welded aluminum structure with aluminum handrails down each side and non-slip treads with adjustable footpads. 19.50" wide treads, 28.25" between rails, 8" risers.

Stair Size	Elevation	Price
4 step	37" — 49"	\$795
5 step	45" — 57"	\$845
6 step	53" — 65"	\$895

Waterfront Access : Aluminum Stairs

Our lightweight aluminum stair kits are designed for a variety of applications. Offering a lifetime of virtually maintenance free features, these quality aluminum stairs are an economical solution for waterfront or hillside access and ideal solution to replacing your old wooden steps. Not recommended for in-water use.

Aluminum Stair Features

- Readily available in lengths up to 18 feet
- Non-skid, 28" wide aluminum stair treads
- Rounded aluminum handrails on both sides
- Adjustable rise & run (27 to 44 degrees) to accommodate your site
- Marine grade aluminum extrusions with stainless steel fasteners (not recommended for in water use)
- Lightweight & easy to carry for a two-person installation
- Custom fabrication available for specific applications & lengths (see custom catalog or our website)
- Optional adjustable footpads for base of stairs
- Includes mounting bracket (designed for easy seasonal installation & removal of stairs)

A woman with blonde hair, wearing a blue and white plaid shirt and tan shorts, is walking down a set of aluminum stairs. The stairs are attached to a wooden dock. The background shows lush green trees and a body of water.

6-step aluminum stairs and 3' x 4' stair platform as a transition to our Medium Duty Aluminum Leg Docks



Above: Aluminum stair system on a site with a steep shoreline with 3' x 4' platforms as landings for each section of stairs.

Below: 10-step stairs used as a transition to our heavy duty steel truss docks.



Truro, MA

Above: Stair system on an oceanfront property can be easily removed in winter to protect the stairs.

Stair system being installed by one of our crews.

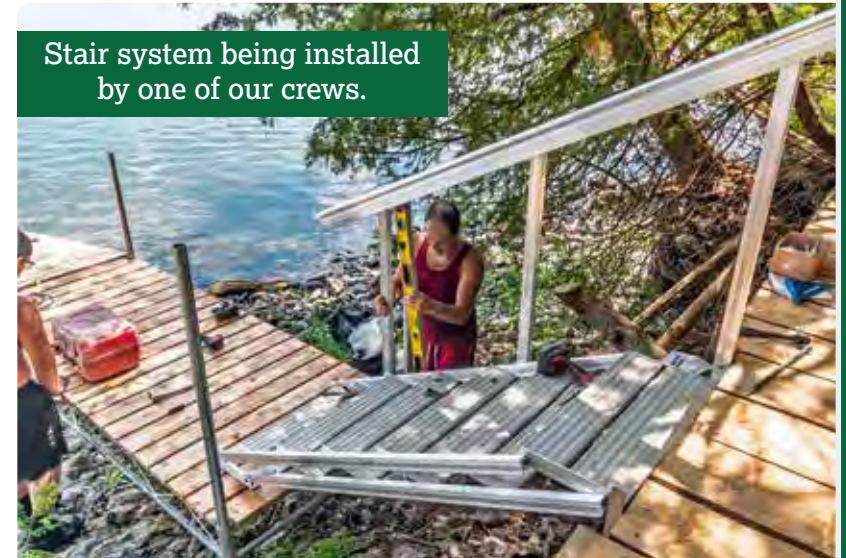

Waterfront Access : Aluminum Stairs

Calculate shipping costs on our website at:

www.thedockdoctors.com/stair-kits



3' x 4' stair platform



3' x 4' stair platform

Above: Aluminum stair system on a site with a steep shoreline, transitioning to our medium duty aluminum dock system. This stair system includes a 10-step, a 16-step and a 4-step set of stairs and utilizes our 3' x 4' platform (shown left) as landings for each section of stairs.



4 and 6-step stairs
ship UPS ground



6-step



8 thru 16-step
stairs
ship freight



8-step

Aluminum Stairs

All stairs can be assembled to fit any distance between the minimum and maximum rise.

All stair treads are 28" wide

# of Steps	Price*	MINIMUM RISE			MAXIMUM RISE			Weight
		Rise @ 6" (27°)	Run with 6" rise	Length with 6" rise	Rise @ 9" (44°)	Run with 9" rise	Length with 9" rise	
4	\$1,025	2' 0"	4' 7"	5' 0"	3' 0"	3' 11"	4' 11"	70 lbs.
6	\$1,325	3' 0"	6' 6"	7' 2"	4' 6"	5' 6"	7' 1"	100 lbs.
8	\$1,625	4' 0"	8' 5"	9' 4"	6' 0"	7' 1"	9' 3"	122 lbs.
10	\$1,925	5' 0"	10' 4"	11' 6"	7' 6"	8' 8"	11' 5"	150 lbs.
12	\$2,225	6' 0"	12' 3"	13' 8"	9' 0"	10' 2"	13' 7"	174 lbs.
14	\$2,525	7' 0"	14' 2"	15' 10"	10' 6"	11' 9"	15' 9"	202 lbs.
16	\$2,825	8' 0"	16' 1"	18' 0"	12' 0"	13' 3"	17' 11"	225 lbs.
n/a	\$820	3' x 4' stair platform (standard duty aluminum with aluminum decking)						45 lbs.

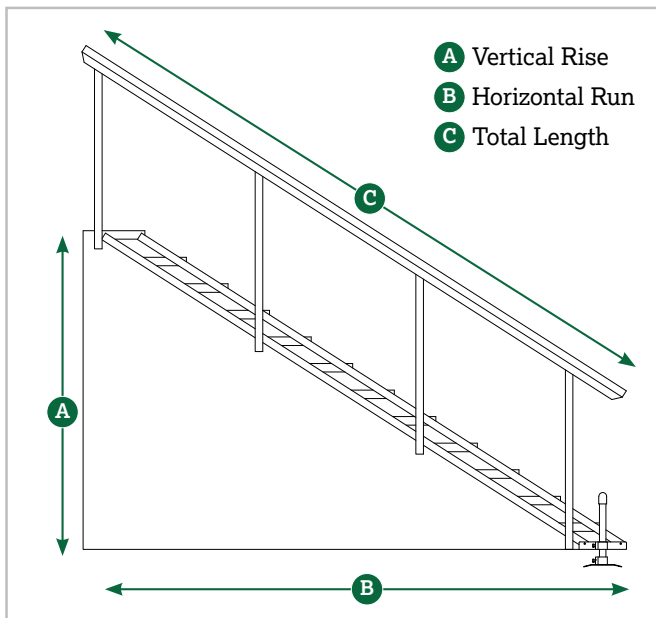

How to measure for stairs

A few simple measurements can help determine the recommended length of stairs for your particular site. For tips on how to measure, visit our website at:



www.thedockdoctors.com/stair-kits



Assembly Options:

Unassembled: Requiring assembly on site to contour to desired rise (note: some drilling is required).

Pre-assembled: Factory assembled and adjusted to desired rise (note: additional assembly charge will apply).



mounting bracket



rounded aluminum handrail



non-skid, 28" wide aluminum stair treads



(optional)

Adjustable Footpad

\$265 / pair

Requires drilling stair on-site to mount.

*Price includes mounting bracket (fasteners to existing platform not included); handrails down each side and slip resistant stair treads. Stair uprights remain vertical in any rise. Optional top and/or bottom stair platform in 3' x 4' standard duty aluminum. Optional pair of Adjustable Footpads includes brackets to mount to bottom of stairs, 1-1/2" aluminum support pipes 24" long, black safety caps & aluminum footpads. Requires stair frame drilling on-site to mount

Prices do not include shipping/delivery. To calculate shipping to your location, please visit: www.thedockdoctors.com/stair-kits

Leg & Wheel Docks : Standard Duty Aluminum Frames

Designed for smaller lakes and bays, our standard duty aluminum frame leg and wheel docks feature an exceptionally strong aluminum frame. Strong yet lightweight, these docks can be installed by one person.





Standard duty aluminum leg docks with cedar decking and 4,500 lb. vertical boat lift.

Standard Duty Aluminum Leg & Wheel Docks

- Exceptionally strong aluminum frame
- Easy one-person install
- Support stanchions built into the frame for an obstruction-free dock edge
- Removable decking in Cedar, WearDeck™ or attached Sure-Step® decking
- Ipe hardwood decking option also available



see details on page 3



WearDeck™ decking in Weatherwood and our 6-step aluminum stairs (see pages 20-23).

EASY one person install



Our innovative connector clips and lightweight sections allow for one person to easily connect sections together and install the dock system.

Leg & Wheel Docks : Standard Duty Aluminum Frames



Standard Duty Aluminum leg docks with cedar decking, then our Medium Duty Aluminum dock in 6 foot width serves as a shoreside platform.

Standard duty aluminum wheel docks easily roll in and out as the water fluctuates during the season or for seasonal installation and removal.





Kayak Roller (see p. 15)



Storage Racks (see p. 13)



Aluminum Ladders (see p. 19)

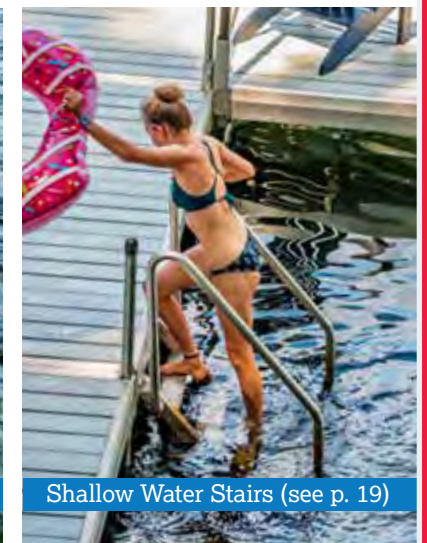

Shallow Water Stairs (see p. 19)

Leg & Wheel Docks : Standard Duty Aluminum Frames

Our 4' x 10' standard duty aluminum leg docks with cedar decking are used as a walkway across a marshy area to access the Battenkill River. The end section (4'3" x 8'5") features Sure-Step flow through decking.



Below: Standard duty aluminum docks with cedar decking and our freestanding launch port system (see page 60 for more details).





Standard Duty Aluminum Leg & Wheel Docks

See decking and color choices on page 8.

		CEDAR	ALUMINUM	WEARDECK™	SURE-STEP®
Stock Size	Weight*	Price	Price	Price	Price
LEG DOCKS					
4' x 8'	49 lbs.	\$860	\$1,175	\$1,135	n/a
4' x 10'	58 lbs.	\$995	\$1,365	\$1,315	n/a
4'3" x 8'5"	103 lbs.	n/a	n/a	n/a	\$1,095
4'3" x 10'5"	125 lbs.	n/a	n/a	n/a	\$1,255
WHEEL DOCKS					
4' x 12'	95 lbs.	\$1,670	\$2,120	\$2,045	n/a
4'3" x 12'5"	149 lbs.	n/a	n/a	n/a	\$1,970

Dock pricing includes frame and removable decking. Wheel dock pricing includes (1) pair of wheels and axle assembly. The necessary assembly components are sold separately. *Weights for docks do not include the decking with the exception of docks with Sure-Step® decking, which attaches directly to the dock frame and is not removable.

Assembly Components

Connector Clips
for connecting docks together
\$37 set of 2



Safety Cap
for 1-1/2" pipe
\$5.75 each



Aluminum Pipe 1-1/2"
cut to length pending water depth
\$9.50 per foot



Footpad (aluminum)
\$48 each



Cross Braces (optional)
stabilizes docks in deeper water
4 foot: \$200
6 foot: \$210
8 foot: \$220
10 foot: \$230



Size based on distance between support pipe.

Leg & Wheel Docks : Medium Duty Aluminum Frames

Our medium duty aluminum frame leg and wheel docks offer superior strength and stability. With a 7" tall frame, these docks come in longer and wider sections than our standard duty frames, yet are still lightweight and easy to install. The support stanchions are built into the frame and flush to the sides of the dock for an obstruction-free dock edge.

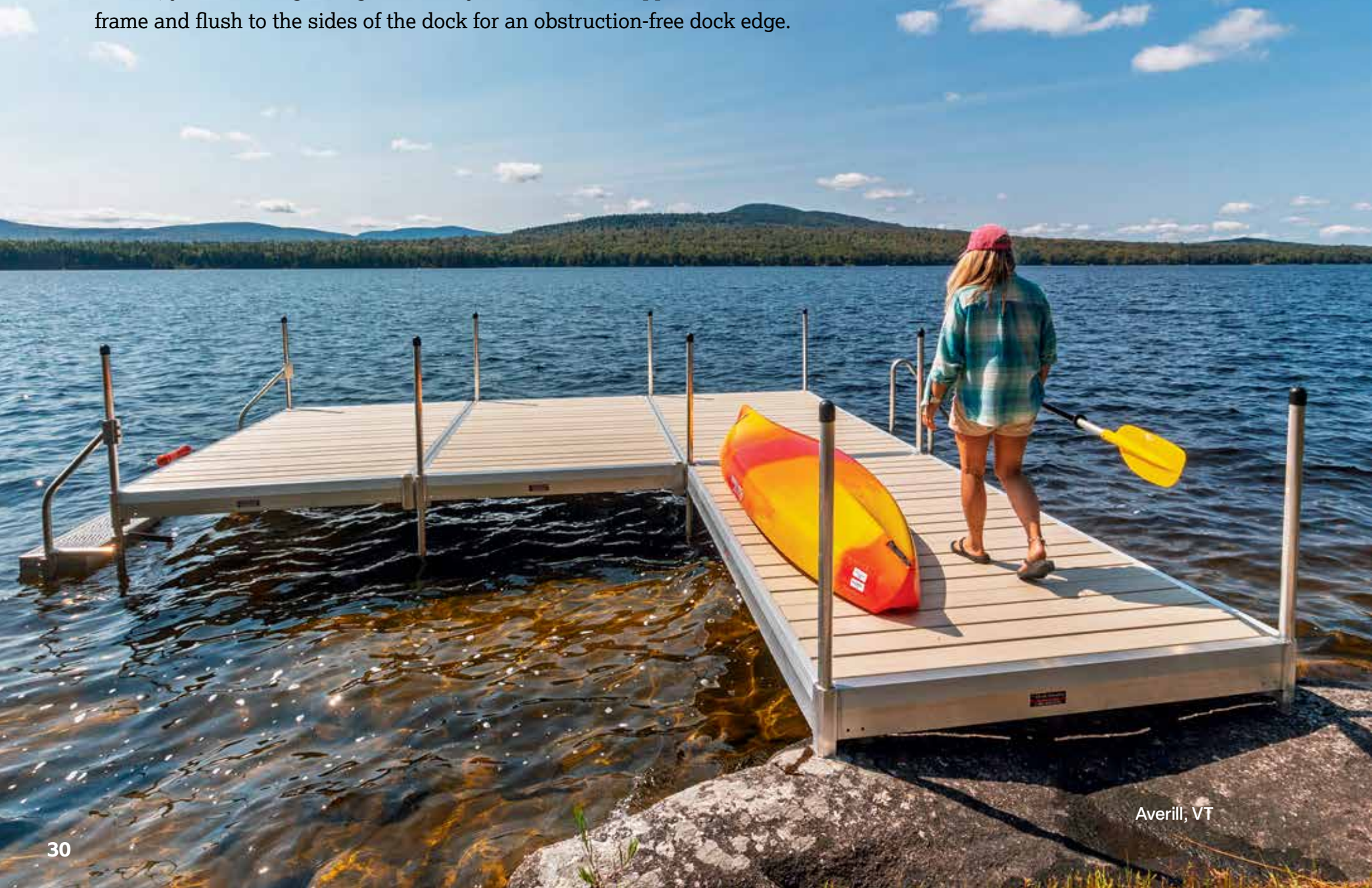

Averill, VT



Medium Duty Aluminum Leg & Wheel Docks

- Exceptionally strong, 7" tall aluminum frame
- Support stanchions built into the frame, for an obstruction-free dock edge
- Removable decking panels in Cedar, WearDeck™ or Aluminum
- Ipe hardwood decking option also available



see details on page 3



Cedar decking and our 6-step aluminum stairs and stair platform (see pages 20-23).

Lightweight sections for easy install



Leg & Wheel Docks : Medium Duty Aluminum Frames





Ausable Forks, NY

Medium duty aluminum leg docks with custom handrails on the 4' x 12' ramp section. Includes our freestanding launch system, shown on pages 60-61.

Leg & Wheel Docks : Medium Duty Aluminum Frames



Lower access platform for paddle sports and swimming.



Optional triangle section for more deck space.



Cross braces, aluminum ladder and vertical fenders.





6' x 8' Leg Dock
with removable deck panels



4' x 16' Wheel Dock
with removable deck panels



Medium Duty Aluminum Leg & Wheel Docks

See decking and color choices on page 8.

Stock Size	Weight*	CEDAR	ALUMINUM	WEARDECK™
		Price	Price	Price
LEG DOCKS				
4' x 8'	75 lbs.	\$1,105	\$1,395	\$1,350
4' x 10'	89 lbs.	\$1,265	\$1,630	\$1,575
4' x 12'	100 lbs.	\$1,410	\$1,879	\$1,789
6' x 8'	93 lbs.	\$1,435	\$1,860	\$1,760
6' x 10'	111 lbs.	\$1,645	\$2,195	\$2,055
6' x 12'	125 lbs.	\$1,840	\$2,495	\$2,330
3' x 3' triangle corner	30 lbs.	\$630	\$665	\$655
WHEEL DOCKS				
4' x 16'	156 lbs.	\$2,500	\$3,065	\$2,960
6' x 16'	184 lbs.	\$2,815	\$3,695	\$3,450

Dock pricing includes frame and removable decking. Wheel dock pricing includes (1) pair of wheels and axle assembly. The necessary assembly components are sold separately. *Weights for docks do not include the decking.

Assembly Components

Connector Clips
for connecting
docks together
\$48 set of 2



Safety Cap
for 1-1/2" pipe
\$5.75 each



Aluminum
Pipe 1-1/2"
cut to length
pending
water depth
\$9.50 per foot

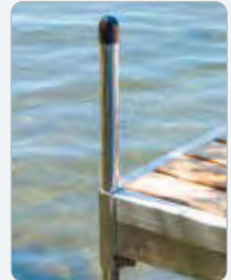

Footpad
(aluminum)
\$48 each



Cross Braces
(optional)
stabilizes docks
in deeper water
4 foot: \$200
6 foot: \$210
8 foot: \$220
10 foot: \$230



Size based on distance between support pipe.

Leg & Wheel Docks : Heavy Duty Galvanized Steel Truss Frames

Designed for exposed sites and rough water conditions, our heavy duty steel truss leg and wheel docks are incomparable for strength and durability. The heavy duty truss frame allows water to pass through the frame in heavy wind and wave locations.



Heavy Duty Steel Truss Leg & Wheel Docks

- Designed for exposed sites
- Heavy duty 9" galvanized steel truss frame with adjustable leg stanchions built into the frame
- Available in 4 foot and 6 foot widths
- Removable decking in Cedar or WearDeck™
- Ipe hardwood decking option also available



see details on page 3



Docks in a "T-shape" configuration with WearDeck™ decking in Weatherwood.



Lower access platform for paddlesports and swimming (see p. 14).



Lake Bomoseen, VT

Leg & Wheel Docks : Heavy Duty Galvanized Steel Truss Frames



Galvanized steel truss wheel docks with cedar decking and 10,000 lb. vertical boat lift.



4' x 16' wheel dock with "L"





2' x 10' standard duty catwalk for easy dock access.



Docks in a "U-shape" configuration with 6,000 lb. vertical boat lift.

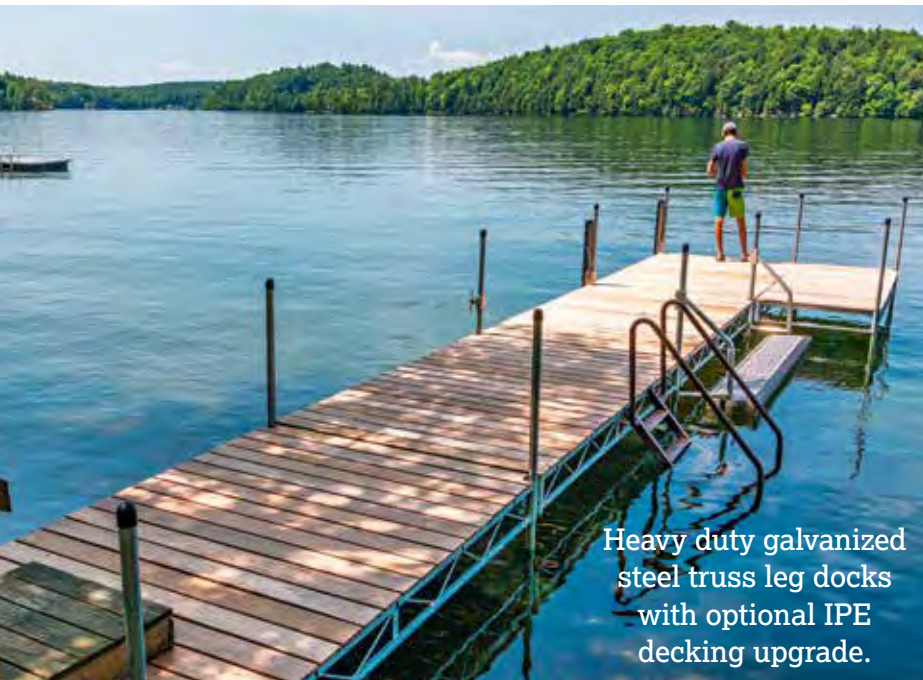

Heavy duty galvanized steel truss leg docks with optional IPE decking upgrade.

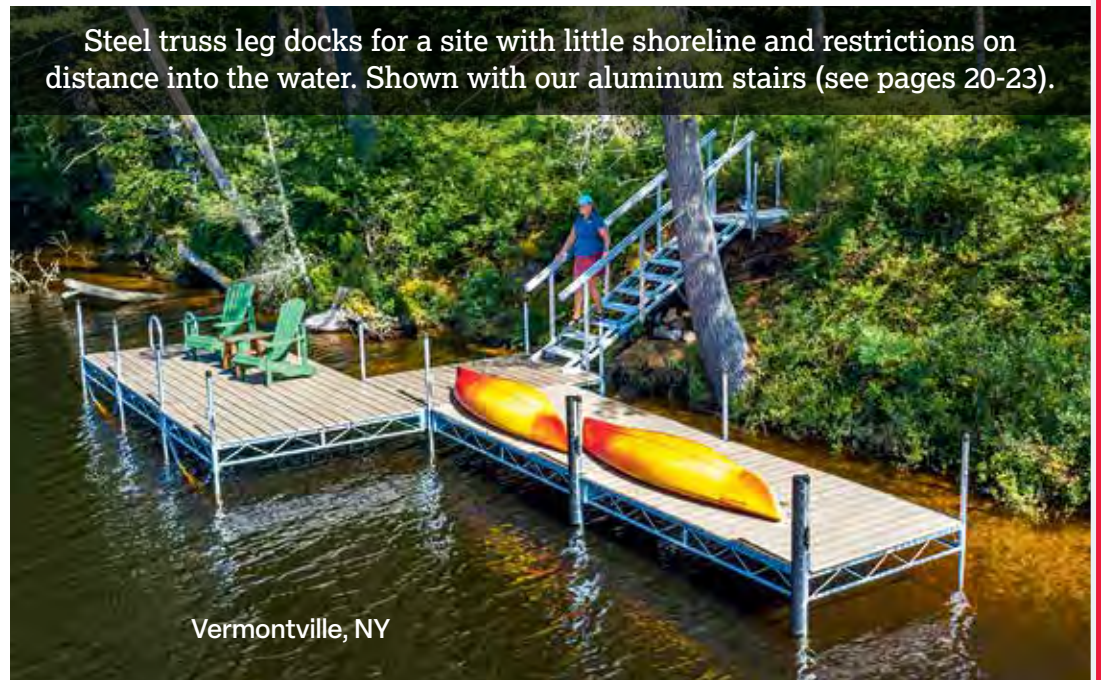

Steel truss leg docks for a site with little shoreline and restrictions on distance into the water. Shown with our aluminum stairs (see pages 20-23).

Vermontville, NY

Leg & Wheel Docks : Heavy Duty Galvanized Steel Truss Frames



Steel truss leg docks with cedar decking and 6,000 lb. Vertical Boat Lift. The dock sections "ramp down" because this site has seasonal water level fluctuation.

Lake Champlain, VT

Shallow Water Stairs (p. 19)



Aluminum Stairs (pp. 20-23)



Lower Access Platform and Aluminum Ladder (p. 14)



Vertical Fenders (pp. 10-11)





4' x 10' Leg Dock
with removable deck panels



4' x 16' Wheel Dock
with removable deck panels



Heavy Duty Galvanized Steel Truss Leg & Wheel Docks

See decking and color choices on page 8.

Stock Size	Weight*	CEDAR	WEARDECK™
		Price	Price
LEG DOCKS			
4' x 8'	100 lbs.	\$1,275	\$1,535
4' x 10'	115 lbs.	\$1,385	\$1,690
6' x 8'	125 lbs.	\$1,665	\$1,985
6' x 10'	145 lbs.	\$1,760	\$2,185
2' x 10' catwalk (std duty**)	75 lbs.	\$735	\$885
3' x 3' triangle corner	19 lbs.	\$450	\$490
WHEEL DOCKS			
4' x 16'	208 lbs.	\$2,755	\$3,210
6' x 16'	265 lbs.	\$3,105	\$3,740
4' x 16' with 4' x 8' L	316 lbs.	\$4,060	\$4,734
6' x 16' with 4' x 8' L	373 lbs.	\$4,425	\$5,230

Dock pricing includes frame and removable decking. Wheel dock pricing includes (1) pair of wheels and axle assembly. The necessary assembly components are sold separately. *Weights for docks do not include the decking. **Catwalk shown on page 39, top left.

Assembly Components

Connecting Brackets

each connection requires (4)

End-to-end: **\$19/ea**

Side-by-side: **\$19/ea**

Catwalk (3"): **\$16/ea**

catwalk requires (2)
3" brackets & (2) truss
end-to-end brackets



Safety Cap for 1 1/2" pipe

\$5.75 each

Galvanized Pipe 1-1/2"

cut to length pending
water depth

\$9.50 per foot

Footpad (galvanized steel)

\$50 each



Dock Panel Securing Cord

\$6 pack of 4



Cross Braces (optional)

stabilizes docks
in deeper water

4 foot: \$200

6 foot: \$210

8 foot: \$220

10 foot: \$230



Size based on distance between support pipe.

Leg & Wheel Docks : Mega Duty Galvanized Steel Truss Frames

Designed for use in rough and deep water applications, our mega duty steel truss leg and wheel docks feature taller frames, longer and wider sections, and larger diameter upright supports than our heavy duty steel truss dock systems. Available in two sizes (or contact us for custom dock size options).



Mega Duty Steel Truss Leg & Wheel Docks

- Designed for use in rough & deep water applications
- 11" tall galvanized steel truss frame
- 3" diameter upright supports
- Stocked in 6' x 20' & 8' x 20' sizes (custom sizes available)
- Adjustable leg stanchions built into the dock frame
- Removable decking in Cedar or WearDeck™
- Ipe hardwood decking option also available



see details on page 3

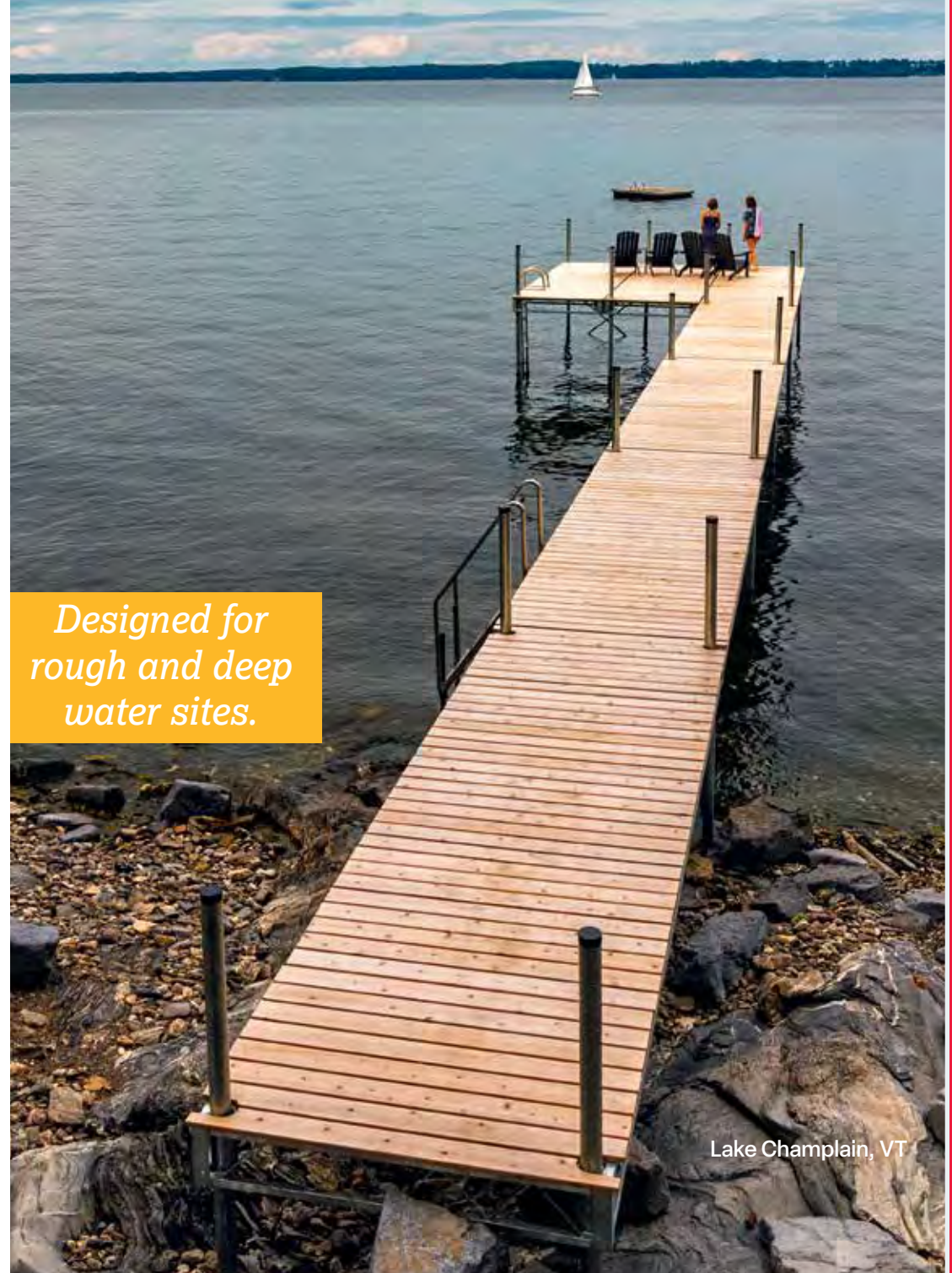

Lake Champlain, VT

Leg & Wheel Docks : Mega Duty Galvanized Steel Truss Frames



Our Mega dock in a U-shaped configuration to create a boat slip. Shown with optional skirt boards to camouflage the steel truss frame and vertical fenders (see D on page 11). WearDeck™ decking in Saddle.

Lake George, NY



Dock frames being manufactured in our Vermont Facility.

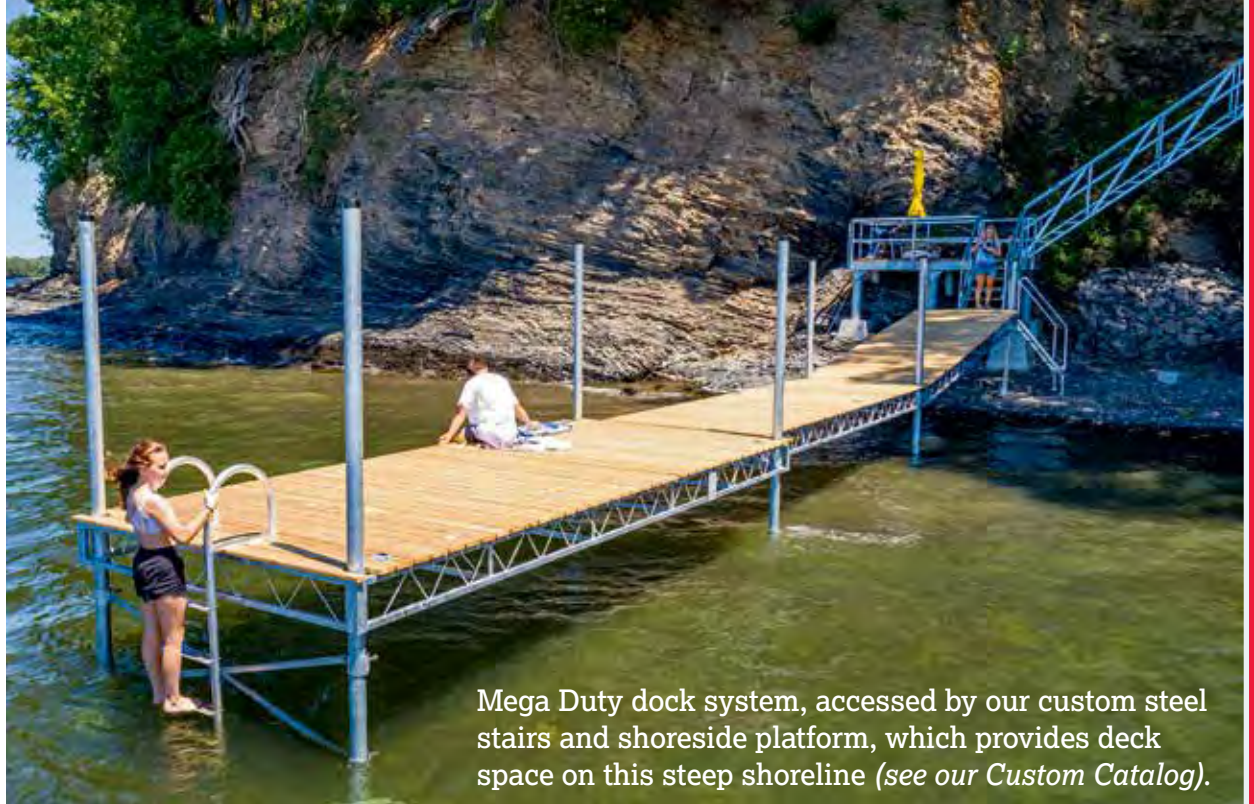

Mega Duty dock system, accessed by our custom steel stairs and shoreside platform, which provides deck space on this steep shoreline (*see our Custom Catalog*).



Delivery of a mega dock system & boat lift to an island site.



Mega dock system being installed by one of our crews.



WearDeck™ decking in Weatherwood.

Leg & Wheel Docks : Mega Duty Galvanized Steel Truss Frames



3' x 24' aluminum gangway (see page 53)



Mega Docks in a U-shape to create a boat slip. Custom aluminum canopy mounts and Sunbrella canopy in Forest Green.



6' x 20' Mega Duty Leg Dock
with removable deck panels



Mega Duty Galvanized Steel Truss Leg & Wheel Docks

		CEDAR	WEARDECK™	IPE HARDWOOD <small>available as a special order</small>
<small>See decking and color choices on page 8.</small>				
Stock Size	Weight*	Price	Price	Price
LEG DOCKS				
6' x 20'	418 lbs.	\$5,365	\$6,080	<i>please call</i>
8' x 20'	490 lbs.	\$7,180	\$8,210	<i>please call</i>
WHEEL KITS				
for 6' wide docks	\$629			
for 8' wide docks	\$649			

Dock pricing includes frame and removable decking. Wheel dock pricing includes (2) pairs of wheels and axle assembly. The necessary assembly components are sold separately. *Weights for docks do not include the decking.

Assembly Components

Connecting Brackets
each connection requires (4)
\$35 each



Safety Cap for 3" pipe
\$7.25 each



Galvanized Pipe 3"
cut to length pending water depth

\$18.00 per foot
Footpad (galvanized steel)
\$66 each



Dock Panel Securing Cord
\$6 pack of 4



Cross Braces (not shown)
stabilizes docks in deeper water
6' wide docks: \$235
8' wide docks: \$245

Mega Dock Adjustment Kit
adjust the level of your dock with this kit that slides over the 3" leg pipe
\$589 per pair



Floating Docks : Medium Duty Aluminum Frames

Our medium duty aluminum floating docks feature our “aluminum track” frame, allowing for easy mounting of hardware and accessories. These pre-manufactured “stock” docks are readily available for pick up, delivery or installation and are designed to be easily installed for the do-it-yourselfer.



Saranac Lake, NY

Medium Duty Aluminum Floating Docks

- Exclusively designed frame by The Dock Doctors®
- Track-style 5" tall aluminum frame allows for easy mounting of hardware & accessories
- Removable decking panels in Cedar, Aluminum or WearDeck™
- Ipe hardwood decking also available
- Black polyethylene flotation filled with expanded polystyrene



see details on page 3



Our unique float frame and hinge-system allow for a seamless transition from gangway/ramp to dock (no step down) & adjusts to fluctuating water levels.



Vermontville, NY



Float Frame

Floating Docks : Medium Duty Aluminum Frames



Lake Champlain, Shoreham, VT

Above: This dock system features a fixed to floating combination of dock styles for use on bodies of water that have fluctuating water levels. The transition piece (shown left) allows for horizontal movement while the floating dock can float up and down on the anchoring.



Wheel mounts



Medium Duty aluminum floating dock with WearDeck™ decking in Weatherwood. Includes custom aluminum handrail and wheel mounts for ease of seasonal installation and removal.



Schroon Lake, NY

Medium Duty aluminum floating docks with WearDeck™ decking in Weatherwood. 3' x 24' aluminum gangway (shown right) with aluminum treadplate for a seamless transition from shore to dock.

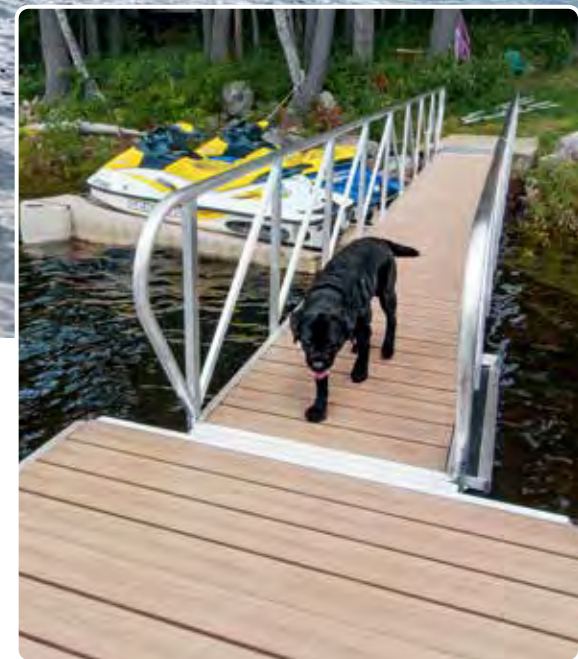

Vermontville, NY



Floating Docks : Medium Duty Aluminum Frames



Aluminum floating dock with aluminum decking and optional edge fender.



Aluminum docks being manufactured in our Vermont facility.



Aluminum floating docks ready for delivery.

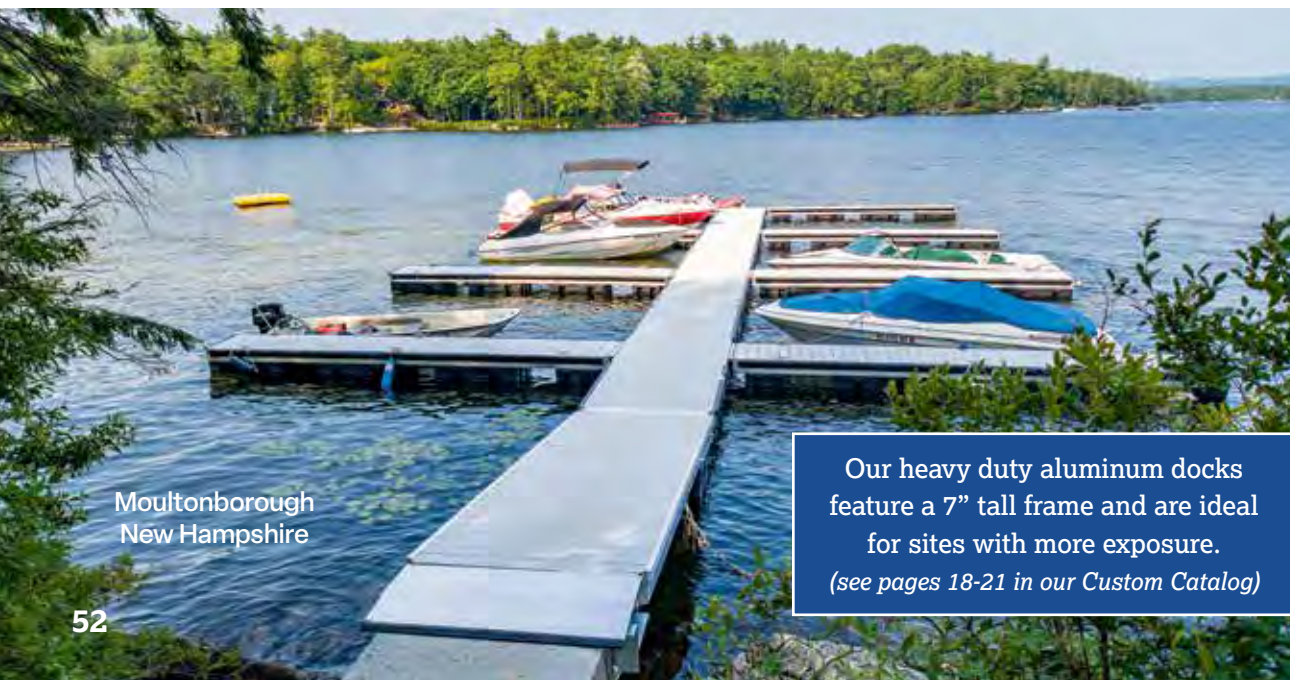

Moultonborough
New Hampshire

Our heavy duty aluminum docks feature a 7" tall frame and are ideal for sites with more exposure.
(see pages 18-21 in our Custom Catalog)

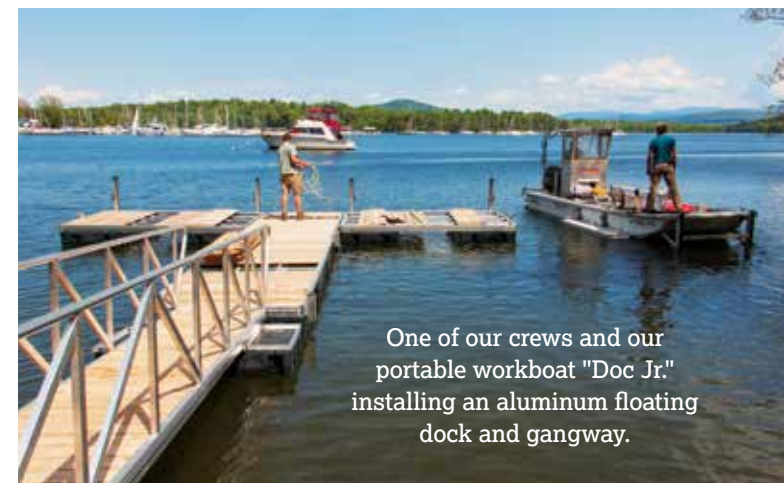

One of our crews and our portable workboat "Doc Jr." installing an aluminum floating dock and gangway.



Medium Duty Aluminum Floating Docks

See decking and color choices on page 8.

Stock Size	Weight*	CEDAR	ALUMINUM	WEARDECK™
		Price	Price	Price
FLOATING DOCKS				
4' × 12'	200 lbs.	\$2,215	\$2,620	\$2,550
4' × 16'	260 lbs.	\$2,775	\$3,330	\$3,215
6' × 12'	256 lbs.	\$2,990	\$3,595	\$3,525
6' × 16'	368 lbs.	\$3,745	\$4,555	\$4,320
8' × 12'	352 lbs.	\$3,695	\$4,500	\$4,300
8' × 16'	503 lbs.	\$4,555	\$5,640	\$5,365
RESIDENTIAL GANGWAY				
3' × 24'	357 lbs.	\$4,685	\$5,235	\$5,110

Pricing includes frame, decking and flotation. Anchoring, connecting hardware and shore mount sold separately.
 Note: Docks used as a shore ramp may require adjustable float frame and shore connection pending layout.
 Ipe hardwood decking option available. *Weights for docks do not include the decking.

Assembly Components

Hinge Connector Kits

Hinge connector kits include bushing, stainless steel pins, wear and dampener system and protective cap (not shown).

\$ 225
(for 4' wide docks)

\$ 230
(for 6' wide docks)

\$ 235
(for 8' wide docks)



Safety Cap
for 2" pipe
\$ 6.25 each

Galvanized Pipe 2"
cut to length pending water depth
\$ 14 per foot



Anchor Mounts:
Spud Pole: **\$ 305**
pipe sold separately



Chain Tube: \$165
chain for anchoring sold separately

Chain:
3/8" galvanized
\$4.95 per foot



Floating Docks : Heavy Duty Aluminum Paddle Docks

Featuring heavy-duty aluminum frames, our "low profile" paddle docks are suitable for commercial or residential applications. Their modular design allow for a variety of layout options.



Heavy duty aluminum paddle dock at a State Park. Shown with optional vinyl edge fender and WearDeck™ decking in Barefoot Sand.



Low freeboard for easy paddle craft boarding.

Paddle Docks (Heavy Duty Aluminum)

- 7" Aluminum Track Frame
- 10"– 12" freeboard – pending sections, sizes, and decking choices
- Heavy duty, stainless-steel connection hinges
- Optional powder coated frame
- WearDeck™ or Ipe decking
- Black polyethylene flotation filled with expanded polystyrene
- Optional marine-grade black vinyl edge fender



10' x 20' paddle dock, 8' x 16' ramp section with Ipe decking and optional angled ladder (inset).

Paddle Docks : Heavy Duty Aluminum

Standard Size <i>with WearDeck decking</i>	Price
8' x 20'	<i>as low as</i> \$8,775
10' x 20'	<i>as low as</i> \$10,675
8' x 16' ramp section	<i>as low as</i> \$6,700
Angled aluminum dock ladder	\$515

Custom sizes and wider ramps available. Standard pricing includes aluminum frame, WearDeck™ decking and flotation.

Site conditions, exposure, anchoring details and ramp requirements to be determined for final pricing.

Please note: Our Aluminum Paddle Docks are not "stocked" items and do not qualify for Free Delivery or Pickup and Save. Please contact us for pricing and delivery/pickup time frames.



Floating Docks : Heavy Duty Aluminum Rowing Docks

Our heavy-duty, aluminum-frame rowing docks feature a modular design that allows for a variety of layout options. Suitable for commercial or residential applications.



Rowing Docks (Heavy Duty Aluminum)

- 7" Aluminum Track Frame with 6"– 8" freeboard
- Heavy duty, stainless-steel connection hinges
- Modular track-style frame for multiple layout options
- Black polyethylene flotation filled with expanded polystyrene
- WearDeck™ or Ipe decking
- Optional marine grade black vinyl edge fender
- Optional debris diverter to protects the dock from floating debris often seen in river settings



City of Dover
Cocheco River
Dover, NH

Rowing Docks : Heavy Duty Aluminum

Standard Size <i>with WearDeck decking</i>	Price
8' x 20'	as low as \$8,700
10' x 20'	as low as \$10,685
8' x 16' ramp section	as low as \$6,800
8' x 16' flared ramp section	as low as \$8,765

Standard pricing includes heavy duty aluminum frame, WearDeck™ decking and flotation. Custom sizes & wider ramps available. Site conditions, anchoring & ramp requirements to be determined for final pricing.

Heavy duty aluminum frame Rowing Dock with 38' x 7' aluminum gangway and commercial kayak launch with ADA transfer platform. Our custom pile dock serves as a shore anchor.

Please note: Our Rowing Docks are not "stocked" items and do not qualify for Free Delivery or Pickup and Save. Please contact us for pricing and delivery/pickup time frames.



Hinge Connections
as low as **\$469**



Edge Fender
\$13.50 per foot installed



Debris Diverter
starting at **\$3,679**



Axle & Wheel Mounts \$895/set
for seasonal installation & removal



Angled Ladder \$515

Paddle Craft Launch Docks : Floating Launch Docks



Residential Dock & Launch System

- Medium-duty 5" tall universal track-style frame
- Polyethylene flotation filled with expanded polystyrene
- Sure-Step non-skid surface on the launch platform
- Boarding handle and grab and launch bars
- Includes 5/4" x 6" WearDeck™ decking

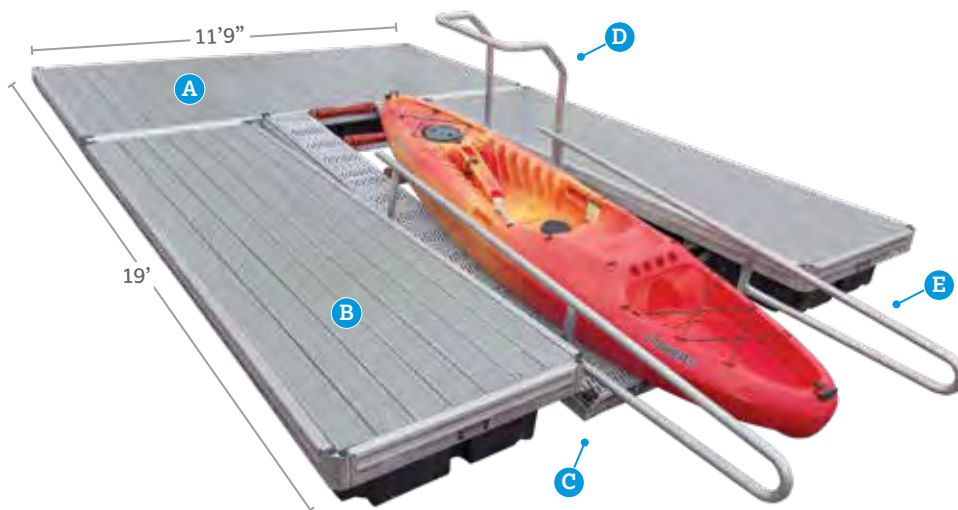

Dock & Launch System : Medium Duty Residential

Featuring a 5" tall aluminum frame, and 19' x 11'9" overall size, our medium duty dock and launch system includes:

- | | |
|--|--------------------------------|
| A (1) main frame (7' x 11' 9") | D Boarding handle |
| B (2) dock fingers (12' x 3' 6") | E Grab and launch rails |
| C Launch ramp (4' x 12')
with built-in rollers & Sure-Step® non-skid decking | |

*** as low as \$17,995**

*Site conditions, anchoring & decking selection are necessary to determine final pricing. Please call for a free estimate.

Please note: Our floating Dock & Launch Systems are not "stocked" items and do not qualify for Free Delivery or Pickup and Save. Please contact us for pricing and delivery/pickup time frames.

Commercial Dock & Launch System

- Heavy-duty 7" universal track-style frame (meets commercial & municipal quality standards)
- Can be used as a complete system or in conjunction with any of our custom floating dock systems
- Sure-Step non-skid surface on the launch platform
- Boarding handle and grab and launch bars
- Includes 5/4" x 6" WearDeck™ decking
- Optional ADA accessible options include transfer platform, ADA curbing and rails



Dock & Launch System : Heavy Duty Commercial

Featuring a 7" tall aluminum frame, and 20'3" x 19' overall size, our heavy duty commercial dock and launch system includes:

- | | |
|---|--------------------------------|
| A (1) main frame (7' x 19') | D Boarding handle |
| B (2) dock fingers (7' x 13' 4") | E Grab and launch rails |
| C Launch ramp (4' 4" x 15')
with built-in rollers & Sure-Step® non-skid decking | |

*** as low as \$25,750**

*Site conditions, anchoring & decking selection are necessary to determine final pricing. Please call for a free estimate.

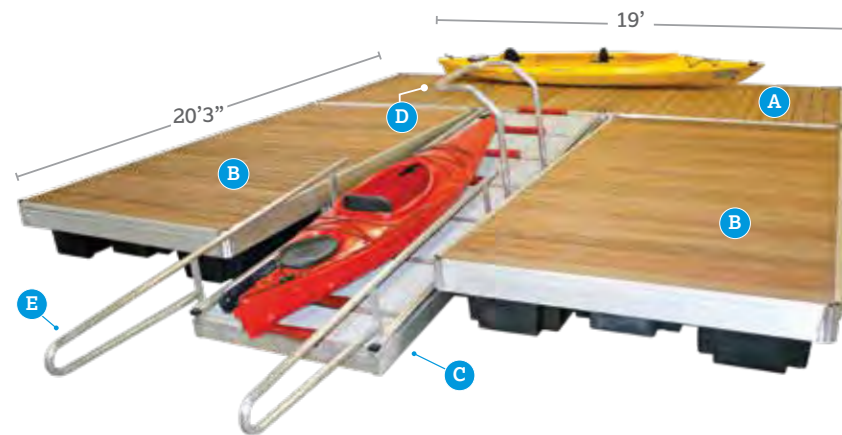

Please note: Our floating Dock & Launch Systems are not "stocked" items and do not qualify for Free Delivery or Pickup and Save. Please contact us for pricing and delivery/pickup time frames.

Paddle Craft Launch Docks & Lifts : Easily board & launch your paddle craft



Ideal for controlled bodies of water with minimal water fluctuation, our freestanding Launch Port System makes boarding and launching your craft a breeze. Sold as an independent launch or can be integrated into a *Dock Doctors* dock system.

Freestanding Launch Port System

- Ideal for controlled bodies of water with minimal water level fluctuation
- Fixed height non-skid Sure-Step® platform
- Non-marring Stoltz® rollers
- Includes (2) standard duty leg dock sections and launch ramp — custom layouts available for your specific site
- Optional grab and launch rails offer more control when gliding on and off the launch platform
- Optional boarding handle provides assistance in and out of the craft



Freestanding Launch Port

Standard Duty Aluminum

Base unit includes:

A (1) 4' × 10' and **B** (1) 4' × 8' standard duty leg dock sections and **C** (1) 4' × 12' launch ramp.

SURE-STEP®

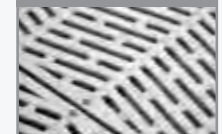

Item

Price

Freestanding Launch Port System

\$ 6,175

D Boarding handle (optional)

\$440

E Grab & launch rails (optional)

\$ 740

Pipe for upright supports sold separately pending water depth and lengths required.

If your water levels fluctuate, our launch port lift has a lifting height of 75" so you can easily launch your kayak, canoe or other small craft from your dock. The platform features non-skid Sure-Step® decking. A 30" handwheel raises and lowers the platform.

Launch Port Lift

- Non-marring Stoltz® rollers
- Non-skid Sure-Step® platform
- Stainless steel fasteners & cables
- 30" handwheel raises & lowers the platform
- 18" adjustable legs (other lengths available)

Specifications

Lifting Height	75"
Overall Width	73"
Overall Length	144"
Weight with platform	400 lbs.



Launch Port Lift

UNASSEMBLED

ASSEMBLED

Item	Price	Price
A Launch Port Lift	\$ 7,395	\$7,795
B Boarding Handle (optional)	\$ 440	
C Grab & Launch Rails (optional)	\$ 740	



Paddle Craft Lift : Residential Small Craft Lifts



Our innovative Kayak Lift & Launch features a platform that raises and lowers so you can safely and easily launch your kayak from a seawall or dock. Available in 3 models to accommodate different lifting heights and craft weights.

Kayak Lift & Launch

- Mounts to seawalls or docks
- Manual winch raises and lowers the platform
- Sure-Step® UV resistant decking on platform
- Boarding handle with built-in paddle storage hooks
- Adjustable aluminum & vinyl bunks
- Three models available
- **FREE UPS shipping** on models KL100-30 & KL100-66L
- Model KL400-72L ships freight - visit our website for a shipping cost to your location

MODEL	A KL100-30	B KL100-66L	C KL400-72L
Lifting Height	30"	66"	72"
Max Craft Weight	100 lbs.	100 lbs.	400 lbs.
Max Craft Beam Width	38"	38"	51"
Ladder	NO	YES	YES
UPS Shippable*	YES	YES	NO (ships freight)

*FREE shipping on KL100-30 and KL100-66L within the continental USA. Optional accessories subject to regular ground shipping costs. Shipping additional for Model KL400-72L, please visit our website to calculate shipping cost to your location. Custom lifting heights available, contact us for details.

B Model KL100-66L

Watch a video of the kayak lift at:
www.thedockdoctors.com/ladder-lift-launch



Lower launch platform and craft.



Transition down the ladder.



Board your craft.



Glide smoothly off.



FREE shipping

A

Photo courtesy of M. Warkentin

Model KL100-30 is ideal for sites that are a minimal distance from the water. With a lifting height of 30" it can accommodate crafts up to a 38" beam width. Includes manual winch, boarding handle, kayak leash and adjustable bunks.



Ships FREE within the continental USA

\$2,300



FREE shipping

B

Model KL100-66L features a built-in ladder and has a lifting height of 66" and can accommodate crafts up to a 38" beam width. Includes manual winch, boarding handle, kayak leash and adjustable bunks.



Ships FREE within the continental USA

\$2,940



SHIPS FREIGHT

C

Designed for larger crafts Model KL400-72L features a built-in ladder and has a lifting height of 72" and can accommodate crafts up to 51" beam width. Includes manual winch, boarding handle, kayak leash and adjustable bunks.

Ships FREIGHT (shipping additional)

\$4,035

This model will accommodate the Hobie Mirage® Tandem

Optional Accessories



Kayak Roller: Assists in moving your kayak onto the bunks. Bolts to side of platform. Cannot be used in combination with Top Transition Step. **\$230**



Top Transition Step: Provides a platform for an easier transition to the ladder or the launch platform. Also assists with loading and unloading your craft. **\$360**



Concrete Installation Kit: For installation on concrete surface. Note: Requires an electric hammer drill with concrete bit sized for the rod listed.

KL100 kit: **\$110**

KL100 kit: **\$119**

Paddle Craft Storage Racks : Accessories for storing your paddle crafts

Marine-grade aluminum frame small craft storage racks. Available in freestanding, wall mounted, and dock mounted styles. Featuring arms with vinyl hull guards and end caps with built-in tie-down openings.



B Single-Sided 3-Craft Storage Rack

Residential Aluminum Storage Racks

- Lightweight aluminum frame storage racks for storing canoes, kayaks, paddle boards and other small crafts
- Adjustable height arms with vinyl hull guards (additional arms available for custom configurations)
- Custom end caps with built-in tie down openings (tie-downs sold separately)
- Crafts can be secured with a cable and lock (not included).
- Stainless steel hardware

Optional Accessories

Adjustable Feet

Ideal for uneven ground. Includes 2 feet, mounting brackets and hardware.

\$210 (pair)



Additional Support Arms

Includes 2 arms, mounting brackets and hardware.

\$150 (pair)



Tie-Down Bungees

Adjustable-length (10–48") with a wrap-and-lock system so you can adjust the tension without unclipping the ends.

\$12 (each)

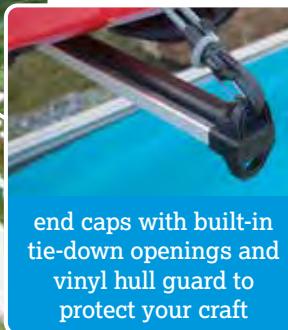

end caps with built-in tie-down openings and vinyl hull guard to protect your craft



adjustable arms with eye-bolts for securing tie-downs



Storage Racks					MARINE GRADE ALUMINUM
Storage Rack Style	Craft Capacity	Unit Weight	(W x D x H) Dimensions	Arm Length	PRICE
A Double-Sided Rack	6-crafts	102 lbs.	80" x 69" x 67"	35"	\$1,220
B Single-Sided Rack	3-crafts	76 lbs.	49" x 69" x 67"	35"	\$915
C Mini Rack (double-sided)**	3-crafts	42 lbs.	43" x 56" x 38"	upper 34" lower 18"	\$635
D Wall-Mounted Rack	3-crafts	44 lbs.	var.† x 38" x 84"	35"	\$680
E Adjustable Feet (pair)	n/a	10 lbs.			\$210
F Additional Arms (pair)††	n/a	8 lbs.		35"	\$150
G Tie-Down Bungees (each)	n/a	n/a			\$ 12 ea

All racks include allen wrench for assembly and adjustment of arm positions. Shipping or Delivery additional - please call for pricing or visit our website. *Assembly service available (additional charge) for racks that are picked-up or delivered only. **Double-sided mini rack is designed as a space saver and requires crafts to be positioned slightly angled on the bottom of the rack. †Wall mount rack dimensions are as follows: Width is variable depending upon installation, Depth is from wall to end of arm. ††Additional arms not available for (C) Mini Rack.

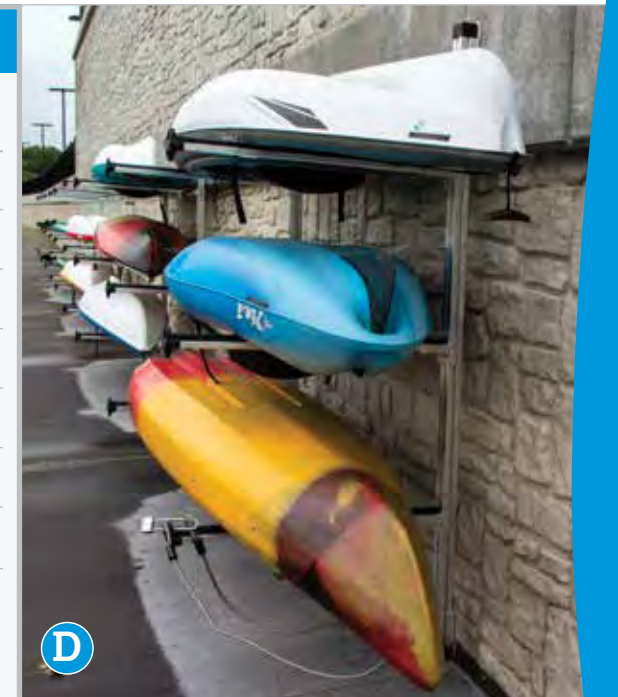

Note: Paddle craft should be stored upside-down to prevent collection of water inside the craft.

Paddle Craft Storage Racks : Structurally designed for commercial use



A Freestanding Commercial Rack in powder coated black finish.

Commercial Storage Racks

Our commercial / municipal storage racks are manufactured with marine-grade aluminum frames and are available in standard aluminum or black powder coated finish.

- Adjustable height arms with vinyl hull guards
- Custom end caps with built-in tie-down openings (tie-downs sold separately)
- Additional arms available
- Standard aluminum or optional black powder coated finish
- Freestanding and concrete mount models
- We can customize any of our storage racks for your specific needs

Commercial Storage Racks

Storage Rack Style	Storage Capacity	Unit Weight	(W × D × H) Dimensions	Arm Length	STANDARD ALUMINUM	POWDER COATED BLACK
					PRICE	PRICE
A Freestanding (Double-Sided)	8-crafts	221 lbs.	93" × 69" × 83"	35"	\$ 2,535	\$ 3,195
B Concrete Mount	8-crafts	172 lbs.	76" × 69" × 72"	35"	\$ 2,375	\$ 2,995
C Additional Arms (pair) ††	1-craft	18 lbs.		35"	\$ 330	\$ 405

All racks include allen wrench for assembly and adjustment of arm positions. Shipping or delivery additional - please visit our website or call for pricing. * Assembly service available (additional charge) for racks that are picked-up or delivered only. Note: Concrete bases not included.

Note: Paddle craft should be stored upside-down to prevent collection of water inside the craft.

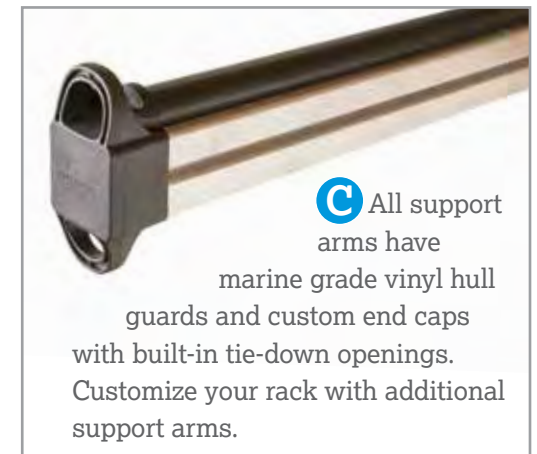

C All support arms have marine grade vinyl hull guards and custom end caps with built-in tie-down openings. Customize your rack with additional support arms.



A Freestanding Commercial Rack in aluminum finish.



A Freestanding Commercial Rack in powder coated black finish.



B Concrete mounted base for secure, permanent installations (concrete bases not included).



Freestanding Commercial Rack with additional arms to store more crafts

C
additional arms



see details on page 3

PWC & Small Craft Lifts

- 1,000 lb. & 1,200 lb. capacity cantilever models
- Stainless steel hardware & cables
- Polymer pulley sheaves prolong cable life
- Dual mounting winch (left or right side)
- 15 Year Limited Warranty
- Manufactured by RGC®
- 1,250 lb. vertical & 2,000 lb. hydraulic models available (see Vertical Lifts on p. 70 or Hydraulic Lifts on p. 74)



Ideal for all types of smaller watercraft.

Model Capacity	PL1000 1,000 lbs	PL1200 1,200 lbs
Max. Beam	64"	70"
Lifting Height	46"	46"
Bed Length	72"	96"
Min. Water Depth	9"	10"
Overall Width	72"	80"
Adjustable Legs	(4) @ 18"	(4) @ 18"
Shipping Weight	155 lbs	257 lbs
Price (unassembled)	\$ 2,500	\$ 3,320
Price (assembled)	\$ 2,700	\$ 3,620



1200 lb. vertical lift (see p. 70)

Boat Lifts : Boat Access & Seasonal Service Tools

Boarding Handle

Our marine-grade aluminum boarding handle provides a safe handhold when boarding your boat. Height from mount to top of handle is 48". See full details on page 15 or on our website.

Boarding Handle: \$135

Mount: \$90

(sold separately)



Sliding Boarding Step

Great for people and pets!

Our sliding boarding step easily slides and retracts so you can safely board your boat from your dock. Securely attaches to your existing dock. Includes a safety handrail that can mount to either side of platform.

Sliding Boarding Step: \$1,155



Boat Lift Installation & Removal Tools

Make the seasonal installation and removal of your boat lift easier with a wheel kit and/or air bag lift system.

A Boat Lift Wheel Kits

Specifically designed for use with RGC® boat lifts.

BLW2045 (fits 2,000 – 4,500 lb. lifts): **\$430 pair**

BLW5060 (fits 5,000 – 6,000 lb. lifts): **\$445 pair**

BLW5075 (fits 5,000 – 8,000 lb. lifts): **\$610 pair**

Wheel kits include a pair of welded galvanized steel mounting brackets and a pair of heavy duty polyethylene wheels. BL5075 kit comes with (4) wheels.

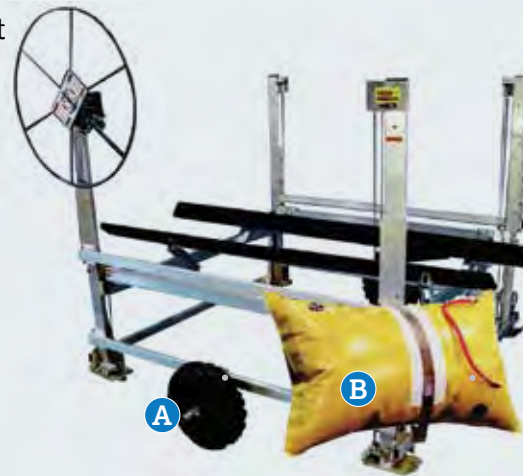

Air Bag Lift Kits / Boat Lift Tubes

Designed to float your boat lift for seasonal installation and removal. Ideal when used in conjunction with a wheel kit (*see photo on left*).

B Enclosed Pillow Lift Bag:

250 lb. capacity: **\$360**

500 lb. capacity: **\$560**

C Boat Lift Tube:

500 lb. capacity: **\$685**

Each kit includes (1) lift bag or (1) tube with a connecting kit (carabiner and strap). Airbag inflates with air compressor with a standard 1/4" NPT air fitting (not included).



Boat Lifts : Vertical Cable Lifts



Vertical boat lifts for any size and style boat:

- All stainless steel hardware & cables
- High lifting range
- Minimal water required
- Manufactured by RGC®
- 15 year limited warranty
- Delivery & installation available



see details on page 3

Above: 4500 lb. vertical boat lift with manual handwheel. Below Left: 10,000 lb. vertical boat lift with A/C direct drive and A/C power. Below Right: 6,000 lb. vertical boat lift with Extreme Max D/C drive and solar power box.



Aluminum Vertical Boat Lifts

Model #	Weight Capacity	Max. Beam	Overall Width	Overall Length	Lifting Height †	Min. Water	Shipping Weight	UNASSEMBLED	ASSEMBLED
								Dock Doctors Price	Dock Doctors Price
VL1250*	1,250 lbs.	65"	73"	82"	75"	8.5"	233 lbs	\$ 4,849	\$ 5,149
VL20100	2,000 lbs.	100"	108"	100"	66"	9.5"	249 lbs	\$ 5,740	\$ 6,240
VL45108	4,500 lbs.	108"	116"	116"	68"	8"	507 lbs	\$ 8,799	\$ 9,399
VL45116	4,500 lbs.	116"	124"	116"	68"	8"	510 lbs	\$ 9,089	\$ 9,689
VL45116 T	4,500 lbs.	116"	124"	116"	80"	8"	523 lbs	\$ 9,379	\$ 9,979
VL60124 T	6,000 lbs.	124"	133"	132"	80"	9"	663 lbs	\$ 10,474	\$ 11,074
VLS80124 T †**	8,000 lbs.	124"	133"	132"	78"	11"	777 lbs	\$ 16,445	\$ 17,245
VLS100132 †**	10,000 lbs.	132"	152"	158"	78"	11"	1,030 lbs	\$ 22,250	\$ 23,250

All pricing is F.O.B. our facility in Ferrisburgh, VT. Prices are for in stock product only. Additional freight charges may apply for special orders. Boat lift prices include (4) adjustable 29" legs with footpads and carpeted pressure treated bunks. Manual handwheel is included with non-electric models. Add desired pontoon or tritoon kit to the lift models as shown on page 73. *Lift includes 18" legs. †**Lifts include AC Direct Drive with remote control and double carpeted wood bunks. † Measured from top of load tubes to bottom of feet when adjustable legs are fully retracted. Measurements are approximate.



see details on page 3

We can even deliver your boat lift assembled.



note: wide load fee applies.

See page 73 for pricing and details on the pontoon and tritoon cradle kits.



4500 lb. boat lift with pontoon cradle kit



6000 lb. boat lift with tritoon cradle kit

Boat Lifts : Vertical Lift Accessories

A Vertical Lift Guides & B Extension Legs

Lift Models	Lift Guides Aluminum & Carpeted	Vertical Lift Extension Legs	
	Tall Lift Guides adjusts from 25"- 43 1/2" high	Ext. Legs 4' pair	Ext. Legs 6' pair
VL3500/4500	\$ 1,175	\$ 375	\$ 475
VL6000	\$ 1,190	\$ 375	\$ 475
VLS8000	\$ 1,445	\$ 390 (5' pair)	\$ 940 (7' pair)
VLS10,000	\$ 1,545*	\$ 390 (5' pair)	\$ 940 (7' pair)

*Note: The guide on option for this lift is carpeted only, not aluminum and carpeted.

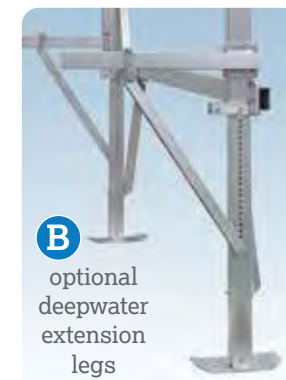

Electric Drive Units

Lift Models	AC Drive Systems				DC Drive Systems		
	C Direct	Direct with remote	Extreme Max Manual	Extreme Max with remote	Direct with remote	Extreme Max Manual	D Extreme Max with remote
VL3500/4500	\$ 2,775	\$ 3,850	\$ 1,900	\$ 2,395	\$ 4,500	\$ 1,900	\$ 2,395
VL6000	\$ 2,800	\$ 3,900	\$ 1,900	\$ 2,395	\$ 4,550	\$ 1,900	\$ 2,395

Note: Drives listed are for lifts with R18 winches only. Please inquire for pricing and information on electric drives for D&L winches.



Direct A/C drive with manual switch.

C Direct Drive This direct drive uses an industrial oil bath gear reducer and motor with a stainless steel cover which connects to the standard winch. Available with a remote control option. Available as an AC or DC unit.

D Extreme Max Drive System Manual key or optional remote control operation with a backup bit for manual operation of the unit in the event of a power outage. Comes complete with mounting kit.

E VL Solar Power Box Portable solar power source for waterfront owners with no electricity. Lightweight white fiberglass box holds (2) deep cycle batteries with a power source on/off switch. Available as solar or with an A/C trickle charger. **Solar charged: \$ 1,690 A/C trickle charged: \$ 1,630**

F Elevated Power Box Stand This stand provides protection for your power box from heavy wave action or high water. Aluminum frame provides 15" of height above the deck surface. **\$ 335 Power box not included in price.**



Extreme Max D/C drive with remote control and solar power box.



Elevated power box stand.



Pacific Blue



Cadet Grey



Forest Green

Traditional canopies shown, please visit our website for other style options available:
www.thedockdoctors.com/canopies

Traditional Sunbrella® Boat Lift Canopies

Lift Models	Description	Price
35108/45108	21' × 108"	\$ 5,385
35108/45108	24' × 108"	\$ 5,830
45116	24' × 116"	\$ 5,975
45116	26' × 116"	\$ 6,125
45116	28' × 116"	\$ 6,710
40124/50124/60124	24' × 124"	\$ 6,095
40124/50124/60124	26' × 124"	\$ 6,325
40124/50124/60124	28' × 124"	\$ 7,015
40124/50124/60124	30' × 124"	\$ 7,255

Please inquire for canopy packages for 8K and 10K vertical lifts

Prices include aluminum canopy frame & fabric in standard colors:

● Pacific Blue ● Cadet Grey ● Forest Green ● Heather Beige ● Slate



Signature colors available as a special order at an additional cost.
 Additional costs for shipping may apply for canopies not in stock.

Pontoon & Tritoon Cradle Kits

Lift Model	Pontoon Cradle & Guide Kit	Tritoon Cradle & Guide Kit	Pontoon Deck Kit
4500	\$ 1,455	\$ 1,880	\$ 990
6000	\$ 1,750	\$ 2,295	\$ 1,010
8000	n/a	\$ 2,345	n/a

Pontoon Cradle & Guide Kit



Pontoon Deck Kit



Boat Lifts : Hydraulic Cantilever Lifts



- Available from 2,000 to 36,000 lb. capacity
- Stainless steel hardware
- Aluminum hydraulic cylinders with stainless steel fittings and hose assemblies
- Full length vinyl bunks
- Pontoon & Tritoon kits available
- Solar or AC charging options
- Manufactured by RGC®
- 15 year limited warranty

- 1 Adjustable width bunks: for a custom fit of your boat hull
- 2 Lateral adjustment: optimize the distance of your lift in relation to your dock.
- 3 Height adjustment: get the right height for your water depth.

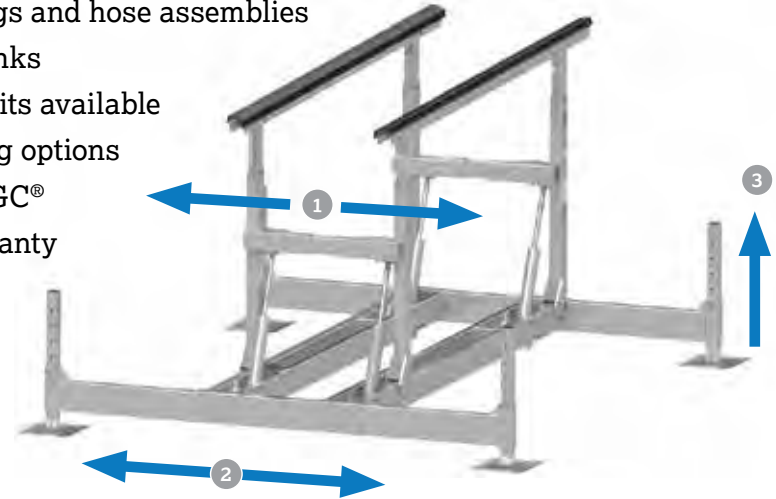

Hydraulic Aluminum Lifts

Boat Lift Model #	Weight Capacity	New HL Flex Feature	Maximum Bunk Width (center to center)	Maximum Lifting Height †	Minimum Bunk Height	Overall Width (including feet)	Overall Length (including feet)	# of Hydraulic Cylinders	Dock Doctors Price	
									UNASSEMBLED	ASSEMBLED
HL20065-60	2,000 lbs.	No	n/a	60"	24.5"	74"	119"	1	\$ 8,705	\$ 8,975
HLF60120-48	6,000 lbs.	Yes	44.5"	48"	29"	137"	151"	2	\$ 14,610	\$ 15,090
HLF70120-60	7,000 lbs.	Yes	44.5"	60"	34"	137"	160"	2	\$ 16,155	\$ 16,635
HLFX2120-60	10,000 lbs.	Yes	50.5"	60"	31"	141"	180"	2	\$ 19,835	\$ 20,555
HLFX2120-48	12,000 lbs.	Yes	50.5"	48"	29"	141"	180"	2	\$ 20,480	\$ 21,440
HLF180144-60	18,000 lbs.	Yes	82"	60"	30"	164"	264"	4	please call	please call
HLF240144-60	24,000 lbs.	Yes	82"	60"	29"	164"	335"	4	please call	please call
HLF360144-60	36,000 lbs.	Yes	82"	60"	29"	164"	335"	4	please call	please call

Package prices above include (4) 3' legs, battery, AC charger & remote control. Solar charging also available for all lifts. All pricing is F.O.B. our facility in Ferrisburgh, Vermont. Prices are for in stock product only. Additional freight charges may apply for out of stock items and special orders. See page 3 for delivery information. † Measured from top of bunks to bottom of feet when adjustable legs are fully retracted. Measurements are approximate.

Pontoon and Tritoon kits available for Hydraulic Lifts - contact us for options and pricing.



Hydraulic lift inside a boathouse.



2,000 lb. capacity hydraulic lift.

HL Boat Lift Accessories: Guides, Extension Hoses and Extension Legs

Lift Model	Aluminum & Wood Guides	Rollers	Stainless Ext. Hose 12' pair	Stainless Ext. Hose 20' pair	Ext. Legs 5' pair	Ext. Legs 7' pair w/ bracing	Ext. Legs 9' pair w/ bracing
6000-10,000	\$ 2,175	\$ 170	\$ 650	\$ 745	\$ 395	\$ 1,275	\$ 1,485
12,000	\$ 4,480	\$ 170	n/a	n/a	\$ 395	\$ 1,500	\$ 1,685

* Guides for 12K lift model are available in aluminum and vinyl only.



Traditional canopy shown above. Please visit our website for other style options available: www.thedockdoctors.com/canopies

Traditional Style Canopies for Hydraulic Lifts

Size	Price
24' x 124" Canopy	\$ 5,695
26' x 124" Canopy	\$ 5,925
28' x 124" Canopy	\$ 6,615
30' x 124" Canopy	\$ 6,855

Note: Prices include standard color Sunbrella® Fabric: ● Pacific Blue, ● Cadet Grey, ● Forest Green, ● Heather Beige & ● Slate. Optional and signature colors are available as a special order (additional cost).



Canopy Leg Kits

Size	Price
4' Canopy Leg Kit with 8' posts	\$ 1,540
6' Canopy Leg Kit with 8' posts	\$ 1,760
8' Canopy Leg Kit with 8' posts	\$ 2,105

All pricing is F.O.B. our facility in Ferrisburgh, VT. Prices are for in stock product only. Additional freight charges may apply for special orders.

Boat Lifts : Ultimate Vertical Lifts

Ideal for boats from 6,000 to 32,000 lbs, our Ultimate Vertical Boat Lifts are manufactured with industrial quality hot-dipped galvanized steel. This lift is designed to be used in shallow, deep and fluctuating water applications. The 12,000 lb. and larger models are custom fabricated in modular sections for ease of seasonal handling.



24,000 lb. capacity lift with front end bow stop, vertical guide-ons and optional oil bath drives.



Ultimate Vertical Boat Lifts by The Dock Doctors®

- Vertical lifts from 6,000 lb. to 32,000 lb. capacity
- 9 ft. standard lift height (other heights available)
- Great for shallow or deep water applications
- Adaptable to boathouses for use with permanent docks
- High lift for rough water & fluctuating water levels
- 12,000 lb. & larger models fabricated in modular sections to facilitate the initial installation
- Industrial quality hot dipped galvanized steel construction, stainless steel cables & galvanized fasteners
- Custom heights, widths & lengths are available to accommodate your boat & location



6,000 lb. capacity Ultimate Boat Lift.



Ultimate lift being installed by one of our crews using our portable workboat "Miss Doc".



Ultimate lift during manufacturing in our Vermont facility.

Boat Lifts : Ultimate Vertical Lifts



18,000 lb. capacity Ultimate Lift with custom canopy.



AC drives and Gem remote controls are standard features on our Ultimate Lifts.



9,000 lb. capacity Ultimate Lift with custom canopy.



12,000 lb. capacity Ultimate Lift installed in a slip within a boathouse with standard vertical guides & upgraded oil bath drives.

Dock Doctors® Ultimate Vertical Boat Lifts

Model #	Capacity	# of Drives	Maximum Beam	Lifting Height	Overall Width	Overall Length	Price*
STOCKED MODELS							
6000	6,000 lbs.	2	9'	9'	11'	12'	\$ 16,300
9000	9,000 lbs.	2	10'	9'	12'	13'	\$ 18,300
CUSTOM MODELS							
12000	12,000 lbs.	4	10' 7"	8' 9"	13'	14'	<i>call to inquire</i>
18000	18,000 lbs.	4	11' 6"	8' 9"	14'	16'	<i>call to inquire</i>
24000	24,000 lbs.	4	13'	8' 11"	16'	18'	<i>call to inquire</i>
32000	32,000 lbs.	4	14'	8' 11"	17'	20'	<i>call to inquire</i>
Auto Stop System (recommended option)							<i>call to inquire</i>

Custom sizes are available. Free delivery or pickup and save does not apply to Ultimate Boat Lifts.

*6K and 9K prices above include Gem remote control, sealed bearing and grooved cable winders, AC drives, (4) 7" vertical guide poles with PVC sleeves, (4) 24" adjustable legs and heavy-duty bunks with vinyl hull guard. Optional oil bath drives and full length guide-ons are available. Please inquire for pricing.



Left: 18,000 lb. capacity Ultimate Vertical Boat Lift with custom bunks for a catamaran hull and upgraded oil bath drives.

Boat Lifts : Boathouse Lifts, Specialty Lifts, Custom Canopies

We custom fabricate lifts for all types of sites & situations: For more information, visit: www.thedockdoctors.com/custom-boat-lifts



Boathouse Lifts are custom built to be installed in new or existing boathouses.



Sling style boathouse lifts for shallow water applications.



Our ultimate lift customized with galvanized lift arms allowing it to be raised for winter storage.



Custom aluminum canopy mounts to attach a standard RGC Canopy to our Mega Dock.



Custom 12,000 lb. hot dipped galvanized steel boat lift incorporated into the pile dock framework in order to maximize the slip width for the customer's boat.

Lake Winnepesaukee, NH

Installation Service - Let the Waterfront Specialists do it for you!



We provide service to all areas in the Northeast



Our portable workboats from 24'-40' in length allow us to provide installation for our products throughout the Northeast.



The Dock Doctors^{LLC}

Waterfront Specialists



Vermont Showroom & Manufacturing Facility
19 Little Otter Ln, Route 7, Ferrisburgh, VT 05456

Lake Placid / Saranac Lake Product Display
876 State Route 86, Ray Brook, NY 12977

ONLINE at: www.thedockdoctors.com
see example projects and our full product line



Open
year-round!



Product Display
Visit Anytime

Monday–Friday: 9am–4:30pm
Saturday: 8am–12pm (April 19th thru June 28th)
Closed Memorial Day Weekend and July 4th

No Staff – No Hours – Come by anytime
and visit our outdoor product display
Located midway between Lake Placid & Saranac Lake

800-870-6756
www.thedockdoctors.com
info@thedockdoctors.com

