

The Dock Doctors[®] LLC

Waterfront Specialists



2022 Stock Catalog

Aluminum Stairs



Boat Lifts



Accessories

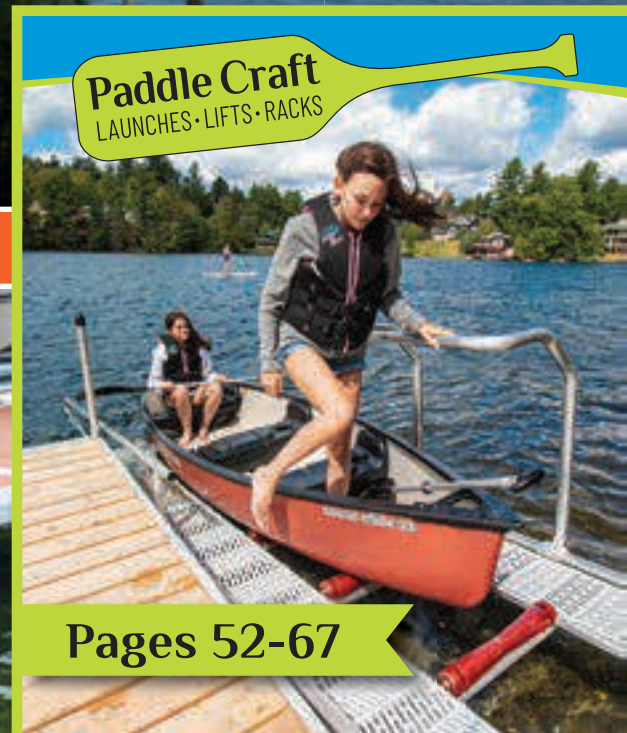

Paddle Craft
LAUNCHES • LIFTS • RACKS

Pages 52-67



Free Dock Design Service

Our experienced staff will create a **FREE dock layout and estimate** designed to your specific site and individual needs.



www.thedockdoctors.com/site-survey
or call us at: **800-870-6756**

See our Custom Catalog or visit our website for all our custom made products

Download at www.thedockdoctors.com/catalogs or call us at 1-800-870-6756 to have one mailed to you today.



CUSTOM CATALOG

- Custom Docks
- Marine Construction
- Custom Stairs & Waterfront Access
- Hillside Trolleys
- Commercial & Municipal Dock Systems
- Marine & Specialty Contractors
- Boat Houses

Paddle Craft

LAUNCHES • LIFTS • RACKS

See pages 52-67 of this catalog for our full line of paddle craft products

- Launch Dock Systems
- Rowing & Paddle Docks
- Launch Lifts
- Storage Racks
- Aluminum Trailers



Swim Floats & Pond Docks (pp. 4-7)



Dock Options & Accessories (pp. 8-18)



Stock Docks readily available (pp. 22-51)



Aluminum Stairs (pp. 19-21)



Launch & Rowing Docks (pp. 52-58)



Boat Lifts & Canopies (pp. 68-80)



Free Estimates & Dock Layout



Free Curbside Delivery* (p. 3)



Installation Services (p. 81)



The Dock Doctors[®] LLC

Waterfront Specialists

Manufacturing Facility &
Vermont Year-Round Showroom

Take a virtual tour of our facility at:
www.thedockdoctors.com/tour

Warehouse & Distribution

Factory Direct

from our door to yours

Local delivery &
installation available
throughout
the Northeast

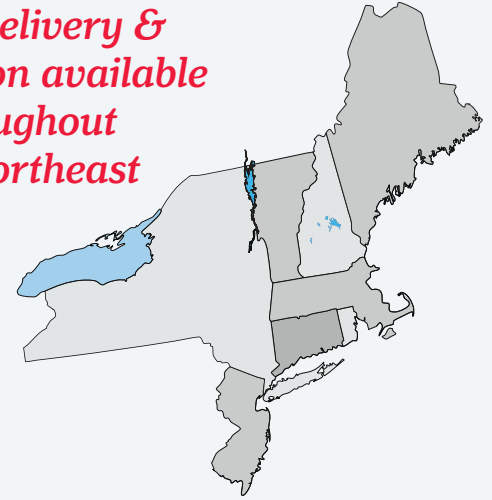

Nationwide Shipping

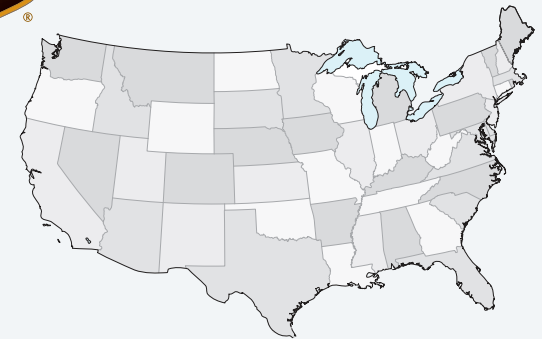

800-870-6756

www.thedockdoctors.com

info@thedockdoctors.com

© Copyright 2022. Prices subject to change.

Our truck indicates stock products that qualify for free delivery* or pick up & save!



Free Delivery

our trucks deliver curbside* to your site

Minimum Purchase Amount (not including sales tax)	Free Delivery from Ferrisburgh, VT (distance based on Google Maps)	Delivery Charge One-Way (over the free mile range)
\$ 2,000	25 miles	\$4. ⁰⁰ / mile**
\$ 4,000	50 miles	\$4. ⁰⁰ / mile**
\$ 6,000	100 miles	\$4. ⁰⁰ / mile**
\$ 8,000	150 miles	\$4. ⁰⁰ / mile** [^]
\$ 10,000	200 miles	\$4. ⁰⁰ / mile** [^]

**Due to fluctuating fuel costs, a fuel surcharge may be applicable.

Pick Up & Save

we will pay you to pick up



Minimum Purchase Amount (not including sales tax)	Pick Up Discount
\$ 2,000	\$75.00
\$ 4,000	\$150.00
\$ 6,000	\$300.00
\$ 8,000	\$450.00
\$ 10,000	\$600.00

*** Free Curbside Delivery Terms & Conditions:** 1. Curbside delivery definition: We will back up as close as we can with our vehicle to your installation site and off-load your product. We cannot carry your product further than the side/rear of our truck/trailer. Our delivery vehicles cannot go off of approved driveway surfaces (ie on grass, etc.). 2. Free delivery available on The Dock Doctors® Stock Products only. Please see chart above for minimum purchase amounts to qualify for free delivery. Free delivery does not apply to Rowing or Paddle Docks or Ultimate Boat Lifts. 3. Boat Lifts, canopies & accessories – free delivery applies to products in stock only. 4. If you want your product installed, please inquire on rates for this service – free delivery does not apply. 5. Additional fees apply for wide loads (assembled boat lifts) & ferry charges, if needed. 6. Purchases under \$2,000 are subject to a \$4.00 per mile one way charge from Ferrisburgh, VT. A ground shipping method/charge by another source such as Common Carrier or UPS may be more feasible depending on product purchased. 7. [^]Due to regulations for hourly driving restrictions by the Federal Motor Carrier there may be an additional fee applicable to deliveries 200 miles or over for overnight charges. 8. Large loads may require assistance on site to off-load.

Swim Floats : Aluminum & Galvanized Steel Frames



Aluminum swim float with Weardeck® decking in Barefoot Sand.

Aluminum Swim Float

Medium-duty, ideal for calm bays or small bodies of water

- Lightweight one-piece aluminum frame
- Removable decking panels
- Stocked in 8' × 8' size



8' × 8' Aluminum Swim Float with removable deck panels shown with 3' ladder

Aluminum Ladder (see page 18)

3 foot: **\$279** 4 foot: **\$299** 5 foot: **\$319**

Aluminum Swim Float (shown above)

Ideal for use in small lakes or calm bays. One piece lightweight aluminum frame with polyethylene floats. Removable decking panels. Optional ladder and anchoring sold separately.



Stock Size	Weight*	CEDAR		WEARDECK®	
		Net Buoyancy	Price	Net Buoyancy	Price
8' × 8'	162 lbs.	865 lbs.	\$ 1,940	787 lbs.	\$ 2,280

SURCHARGE NOTICE - Due to supply issues and cost increases, a 10% surcharge will be applied to all of our printed prices until further notice and is subject to change.

Light Duty Float Harness

Includes shackles, swivel, 3' of 3/8" chain & (2) 10' nylon ropes. **\$115**

Nylon Rope Extension

Amount needed is 1.5 × the water depth

14' (**\$54**), 18' (**\$56**), 22' (**\$58**)

Concrete Anchor (Light Duty)

18" × 8", 180 lbs. **\$132**



For more info on anchoring, visit:

www.thedockdoctors.com/swim-float-anchoring

*Weight is with decking removed. Custom size swim floats available, please contact us for details.

Ipe hardwood or other composite decking options available. See decking details and color choices on page 8.



Galvanized steel swim float with cedar decking.

Heavy Duty Galvanized Steel Swim Float

Ideal for rough water. Dismantles into two pieces for ease of handling. Removable decking panels. Optional ladder and anchoring sold separately.



Stock Size	Weight*	CEDAR		WEARDECK®	
		Net Buoyancy	Price	Net Buoyancy	Price
8' × 8'	238 lbs.	789 lbs.	\$ 2,030	711 lbs.	\$ 2,370
8' × 10'	248 lbs.	778 lbs.	\$ 2,270	638 lbs.	\$ 2,705
10' × 10'	476 lbs.	1,787 lbs.	\$ 3,080	1611 lbs.	\$ 3,620

SURCHARGE NOTICE - Due to supply issues and cost increases, a 10% surcharge will be applied to all of our printed prices until further notice and is subject to change.

*Weight is with decking removed. Custom size swim floats available, please contact us for details.

Ipe hardwood or other composite decking options available. See decking details and color choices on page 8.

Galvanized Steel Swim Float

Heavy-duty, ideal for rough water

- Two-piece galvanized steel frame
- Removable decking panels

8' × 8' Galvanized Steel Swim Float with removable deck panels shown with 3' ladder



Heavy duty galvanized steel swim float dismantles into two pieces for ease of handling.

Aluminum Ladder (see page 18)

3 foot: **\$279** 4 foot: **\$299** 5 foot: **\$319**

Heavy Duty Float Harness

Includes shackles, swivel & (2) 10' nylon ropes. Chain sold separately. **\$180**

Galvanized Chain

Amount of chain needed is 1.5 × the water depth. **\$4.⁹⁵/foot**

Concrete Anchor (Heavy Duty)

2' × 2' × 8", 400 lbs. **\$159**



For more info on anchoring, visit:

www.thedockdoctors.com/swim-float-anchoring

Pond Docks : Aluminum & Galvanized Steel Frames



A 4' x 16' Pond Dock
galvanized steel frame
shown with optional ladder
and composite decking

Designed for ponds or bodies of water with little to no wave activity or water level fluctuation.

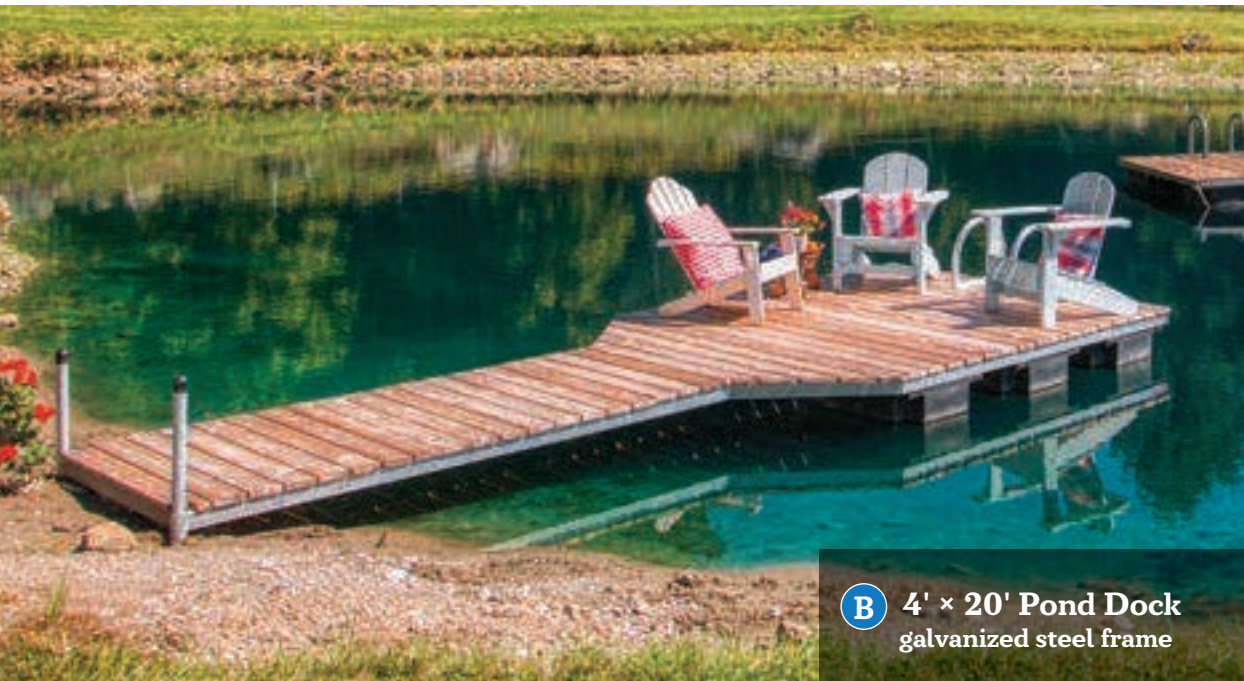

B 4' x 20' Pond Dock
galvanized steel frame

Pond Docks

Available in a galvanized steel frame or 4-piece aluminum frame.

- Removable decking panels
- Galvanized steel frame pond docks available in 4' x 16' and 4' x 20' sizes
- 4-piece aluminum frame pond dock available in 4' x 18' size, designed for common carrier shipping
- Optional aluminum ladder (see p. 18)

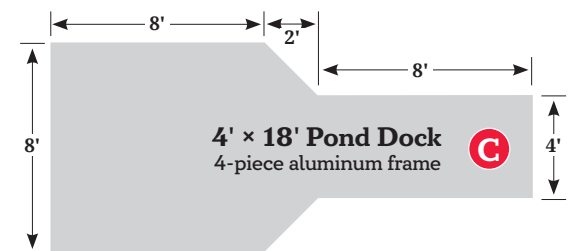
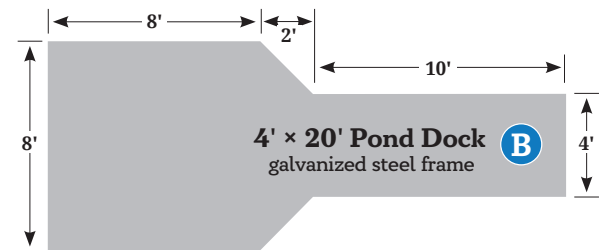
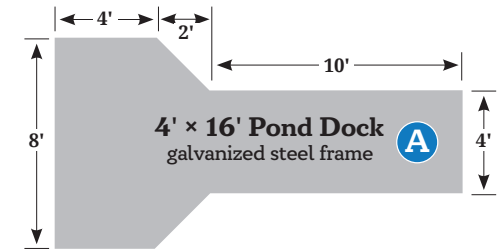



C 4' x 18' Pond Dock
4-piece aluminum frame



C 4' x 18' Pond Dock
4-piece aluminum frame
(shippable)

Pond Docks

Available with a galvanized steel frame, or 4-piece aluminum frame. All pond docks feature removable decking panels and black polyethylene floats. Includes (2) 3 ft. long 1 1/2" pipes with safety caps for shore anchoring.



Stock Size	Weight*	CEDAR Price	WEARDECK® Price
Galvanized Steel Frame			
A 4' x 16' pond dock	289 lbs.	\$ 2,755	\$ 3,435
B 4' x 20' pond dock	410 lbs.	\$ 3,695	\$ 4,565
Aluminum Frame (4-piece)			
C 4' x 18' pond dock	322 lbs.	\$ 3,715	\$ 4,530

SURCHARGE NOTICE: Due to supply issues and cost increases, a 10% surcharge will be applied to all of our printed prices until further notice and is subject to change.

*Weight is with decking removed. **Ipe hardwood or other composite decking options** (available on 4' x 20' pond dock only).
See decking details and color choices on page 8.



**Ships on a
4' x 10' pallet**

Calculate shipping to your location at:
thedockdoctors.com/aluminum-pond-dock

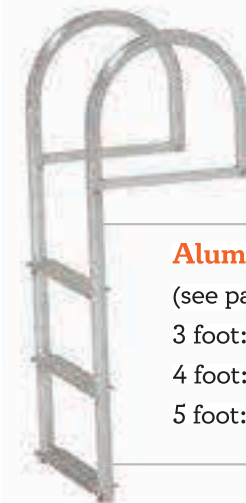

Aluminum Ladder

(see page 18):
3 foot: **\$279**
4 foot: **\$299**
5 foot: **\$319**

Options & Accessories : Decking Choices

Choosing the decking for your new dock system is an important choice, and there are many factors to consider. Maintenance, cost, color and personal style-preferences.



CEDAR is a natural, cost effective decking option that is naturally resistant to decay and insects. We use STK Western Red Cedar (Select Tight Knot Grade or Number 2). It is generally regarded

as a high-quality choice for cedar, and any knots present are sound encased and tight. The wood is generally straight-grained and has a uniform, but rather coarse texture.

CONS: Over time, cedar will absorb moisture and weather to a soft silvery gray, unless sealed with a preserving stain.



ALUMINUM resists the growth of mold and mildew and won't rust, rot, split or stain. This painted then baked beige finish eliminates glare from the aluminum. The non-slip, rigid, surface is

low-maintenance and cool to the touch. Color is Sherman Williams Beige PHT160052.

CONS: Can sound metallic when walking on it, especially on our docks with removable panels.



WEARDECK is a high density polyethylene resin with UV inhibitors. WearDeck's 5/4" thick deck board is rated to span joists 24" on center with the highest live load capacity in the industry. Rated for ground and underwater contact and will not support mold or mildew growth. This product is 100% manufactured in Ocala, FL and



*please inquire for pricing and lead times.

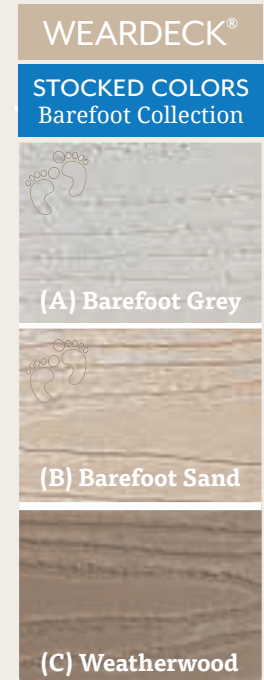

offers a 25 year commercial and a lifetime residential warranty.

Cons: Not a natural wood.

Barefoot Collection
"Lighter Colors, Cooler Touch"

Heat-Reflective Technology

- Reflects the sun's hot rays off the surface of the board
- Reduces surface temperature by at least 30% on each color

Ipe Hardwood Decking Upgrade



IPE is extremely hard, very durable and naturally resistant to rot and insects. Ipe's strong, resilient properties make it an excellent material choice for marine applications.

Cons: Due to the density of Ipe, it is heavy and hard to drill and cut, therefore more labor intensive than working with other decking materials. It is also a natural wood, therefore there will be inconsistencies with regard to color, weathering and texture.



SURE-STEP is a slip-resistant, polypropylene surface that allows water and sunlight through to help conserve the underwater ecosystem. Preferred option for dock structures that are situated close to the water so waves will pass

through the decking, adding minimal resistance. Color: Grey.

Cons: Only available in certain dimensions, so may not be a viable option for many applications.

This product **ONLY** available on our Standard Duty Aluminum Leg & Wheel Docks



Decorative Option

Wooden skirt-boards and cedar post covers are used to camouflage the steel truss frame and leg pipe, providing the appearance of a wooden dock system. Please inquire for pricing and details.



Shipping Available

Protect your boat and dock with our adjustable vertical fenders

(available for all dock systems)

Our Vertical Fenders

offer two forms of adjustment:

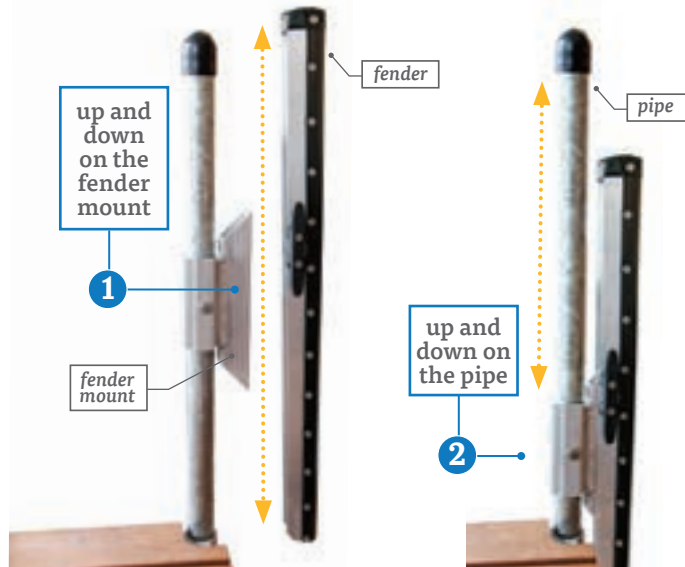

Our unique vertical fender design provides a double adjustment both on the fender mount & on the dock support pipe (see diagram above) – which is often necessary due to lake level and boat style. Add a fender cleat kit (see **G** on p. 11) for a complete securing system for your boat.

Our quality vertical fender material provides adequate cushion for protection – but is firm and slick enough to allow the boat gunnel to slide up and down without friction that could cause damage to seasonal docks.

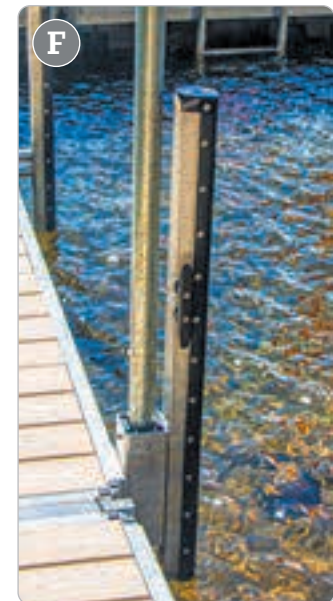
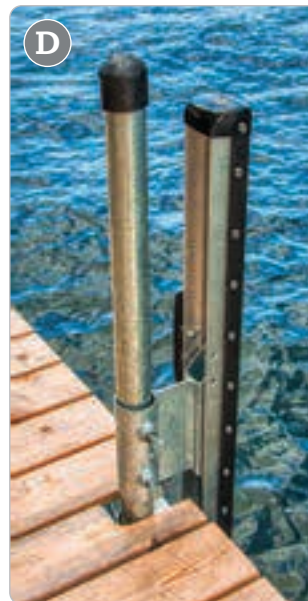

Vertical Fenders, Cleats

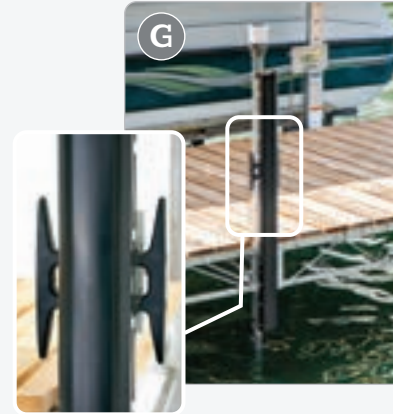

G Fender Cleat Kit

Designed to be used with the 3' or 4' fenders shown on page 10. Includes (2) cleats per kit that bolt onto the fender mount.

\$ 45 per kit

includes 2 cleats and hardware to attach to vertical fender

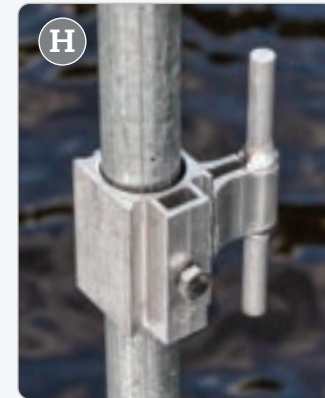

H Pipe Cleat (for 1 1/2" pipe)

A single cleat mounted to a sleeve that slides over the leg pipe. Available for all leg & wheel docks except the mega leg & wheel docks.

\$ 40 each



I Track Cleat

Designed to slide along the track of our floating aluminum track dock systems.

\$ 26 each

Vertical Fenders

Fender Style	Mounting Style	3' long	4' long
<i>For all Aluminum Leg & Wheel Docks & Steel Truss Leg Docks with 1 1/2" pipe:</i>			
A Fender	1 1/2" pipe mount	\$ 169	\$ 189
B Double Corner Fender	1 1/2" pipe mount	\$ 305	\$ 360
<i>For all Steel Truss Wheel Docks with 1 1/2" pipe:</i>			
C Fender with offset	1 1/2" pipe mount	\$ 179	\$ 199
<i>For all Mega Leg Docks with 3" pipe or Custom Articulating Docks with 2" pipe:</i>			
D Fender	2" or 3" pipe mount	\$ 209	\$ 229
<i>For all Aluminum "Track-Frame" Floating Docks:</i>			
E Fender	Track Mounted	\$ 185	\$ 205
<i>For all Aluminum "Track-Frame" Floating Docks - includes spud mount:</i>			
F Fender	Spud Anchor Mounted	\$ 399	\$ 419

SURCHARGE NOTICE: Due to supply issues and cost increases, a 10% surcharge will be applied to all of our printed prices until further notice and is subject to change.

Options & Accessories : Edge Fenders, Mooring Whips

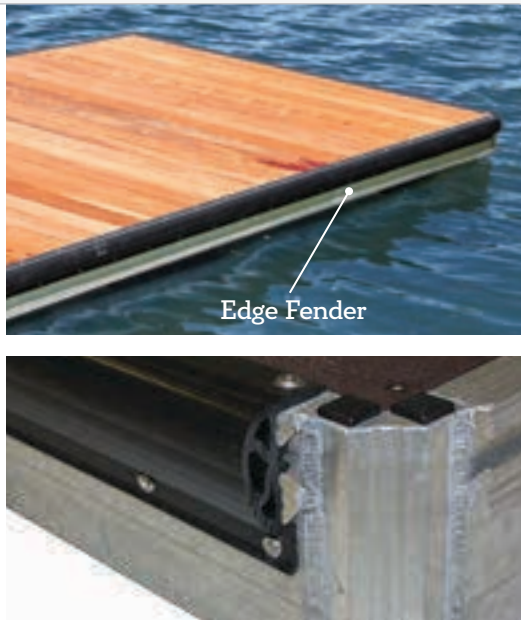

A Edge Fender

An alternative to our vertical fenders, this high quality, non-marring black edge fender can be installed on our Aluminum Leg & Wheel Docks (standard and medium duty), our Aluminum Floating Docks and our Custom Steel Truss Floating Docks.

\$ 8.⁹⁵ per foot

(material only, not installed, not including fasteners)

\$ 12.⁵⁰ per foot

(installed with stainless steel fasteners)*

**installation available on new dock orders only*

SURCHARGE NOTICE: Due to supply issues and cost increases, a 10% surcharge will be applied to all of our printed prices until further notice and is subject to change.



B Taylor Made Mooring Whips

Mooring whips with fixed angle base. Two-piece kit, will need to be epoxied (epoxy included with kit). Recommended for low profile boats such as bass boats, runabouts and sport boats.

MW120: **\$ 615** for 18' – 23' boats / 2,500–5,000 lbs.

MW140: **\$ 715** for 24' – 28' boats / 5,000–10,000 lbs.

Disclaimer: Some docking conditions may be too rugged for this product.

C Mooring Whip Dock Mounts (for Dock Doctors docks)

Required for docks with removable decking. **\$ 179**
(for Taylor Made mooring whip models listed above only)



Heavy Duty and
Mega Dock Truss
Frame Mount



Aluminum Track
Frame Mount

Dock Mounted Storage Racks

See our full line of Paddle Craft Products on pages 52-67

Dock Mounted Storage (Kayak, Canoe, Paddleboard)

Marine-grade aluminum small craft storage. Arms feature vinyl hull guards and end caps with built-in tie-down openings. Crafts can be secured with a cable and lock (not included).



Shipping Available



A

A Storage Arms (pair) (single craft, dock mounted)

A pair of storage arms which slide onto the leg pipes of your dock. Arms are 35" in length. *Note: Fits all docks with 1 1/2" pipe*.*

Storage Arms (pair): \$ 199

Designed for 1 1/2" SCH #40 pipe and will work with any pipe that measures 1-15/16" O.D. (outside diameter).



B

B Storage Rack (2-craft, dock mounted)

Our two-craft storage rack mounts to the frame of your dock and stores two crafts and paddles/oars. Top arm is 35", bottom arm is 18" (wider crafts can be stored at an angle).

Storage Rack (2-craft): \$ 598

Mounts Available
(please indicate when ordering):

- Dock Doctors Steel Truss Frame mount
- Dock Doctors Aluminum Track mount
- Universal Mount (for wood dock systems)



A



B

SURCHARGE NOTICE: Due to supply issues and cost increases, a 10% surcharge will be applied to all of our printed prices until further notice and is subject to change.

Options & Accessories : Boat & Paddle Craft Access



Lower Access Platform : *for swimming & kayaking*

Stationary leg docks are often quite a distance above the waters' surface, making accessing the water for swimming or kayaking very difficult. Our lower access platform is designed to provide you with a safe transition to the water.

- 5" tall aluminum frame
- Sure-Step® flow-thru, anti-slip decking
- Designed to be used alongside any 8'-10' long dock with 1 ½" support pipes
- Adjustable sleeves slide over 1 ½" support pipes

Lower Access Platform: \$885

add optional ladder (see p. 18)



SURCHARGE NOTICE: Due to supply issues and cost increases, a 10% surcharge will be applied to all of our printed prices until further notice and is subject to change.

Boat & Paddle Craft Access

A Dock Mounted Roller

A single 12" keel roller designed to assist you when moving canoes, kayaks, or other small crafts on or off your dock.

Dock Mounted Roller: \$ 133

A1 Universal Surface Mount or A2 Track Frame Mount for Dock Doctors Medium Duty Aluminum Floating docks (pages 46 - 51).



Watch a video and find out more at: thedockdoctors.com/kayak-roller

B Boarding Handle

Our marine-grade aluminum boarding handle provides a safe handhold when boarding your boat. Mounts to **Dock Doctors** floating aluminum track dock systems or universal mount to attach to any dock frame. Height from mount to top of handle is 48".

Boarding Handle: \$120

mount sold separately

B1 Universal Mount \$79

B2 Track Mount \$79

for Dock Doctors Medium Duty Aluminum Floating docks (pages 46 - 51).

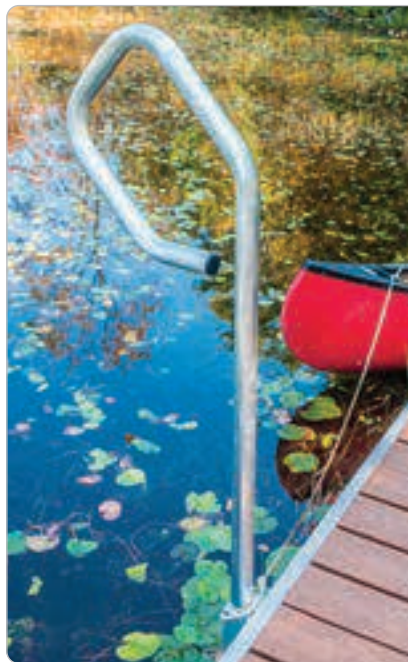

C Sliding Boarding Step Great for people and pets!

Our sliding boarding step easily slides and retracts so you can safely board your boat from your dock. Securely attaches to your existing dock. Includes a safety handrail that can mount to either side of platform. See page 69 for full details and specifications.

Sliding Boarding Step: \$1,050

SURCHARGE NOTICE: Due to supply issues and cost increases, a 10% surcharge will be applied to all of our printed prices until further notice and is subject to change.

Options & Accessories : Sea Gull Eliminators & Solar Lights



Easy Hassle Free Mounting
No Wiring Required



\$ 56.⁹⁵
package of 2

Solar Dock Post Lites

- Fits standard pipes (1 1/2" & 2" ID in size)
- 6" H x 3.5" diameter (UV stabilized polycarbonate)
- (1) Super bright LED (12 Lumens)
- Automatic night activation
- Fully sealed electronic circuit board
- Powerful solar panel
- Lasts 18+ hours on a full charge
- Replaceable 1.2v NiMH battery
- Two (2) post lites in each package



1 3/8" Dock Dots

The smallest solar lights you have ever seen!
Easy to install in minutes with a quick 1 3/8" drill bit or hole saw.

\$ 56.⁹⁵
package of 4 *Available with white LEDs only*



Deck Lights

Industrial strength solar powered dock light. Marine grade anodized aluminum offers superior protection in harsh marine environments.

\$ 37.⁹⁵
each *Available with white LEDs only*

BIRD-B-GONE™ Sea Gull Eliminators



Bird Spider 360°

The spider's spinning motion is effective at deterring birds from landing on your boat, swim raft or dock. Stainless steel arms with scuff-preventing polycarbonate tips move with the breeze. Permanent glue-on base or use optional sandbag mount.

4' Diameter Spider **\$ 49.⁹⁹** 8' Diameter Spider **\$ 59.⁹⁹**



360° Repellent

6' diameter, wind driven rotator keeps birds from roosting on your boat, swim raft or dock. Includes standard mounting block (screws included). Portable sandbag mounts sold separately.

360 Repellent **\$ 49.⁹⁹**



Sandbag Base

Attaches directly to either style repeller (hardware included). Eyelets around outer ring for extra security. Weighs 8 lbs.

Sandbag Base **\$ 41.⁹⁹**

SURCHARGE NOTICE: Due to supply issues and cost increases, a 10% surcharge will be applied to all of our printed prices until further notice and is subject to change.

Seasonal Dock Adjustment Tools & Flag Poles

Adjustment Kit

Adjust the level of your dock with this kit that slides over the 1 1/2" leg pipe. Available for all leg & wheel docks with 1 1/2" pipe. Sold as a pair (winch with sleeve and hook).

\$ 309 / pair

See page 45 for our *Mega Dock adjustment kit*.

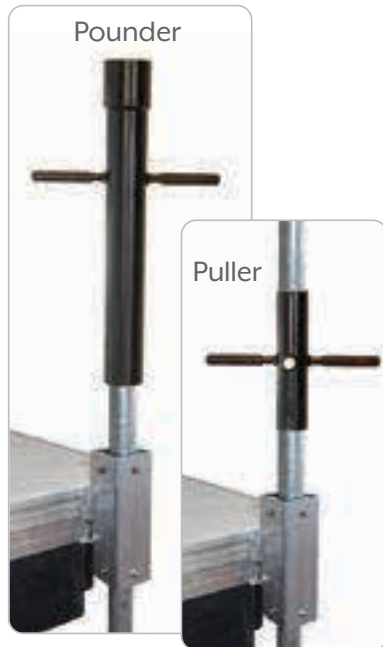

Spud Puller & Pounder Kit

This (2) piece system aids in the installation and removal of spud pole anchors for our floating dock systems.

2" puller/pounder kit: \$ 315

3" puller/pounder kit: \$ 395

16' Aluminum Telescoping Flag Poles

Add beauty to your waterfront property with a telescoping flagpole. Each section of the pole raises and lowers easily, and with no ropes, chains or pulleys they are virtually noise-free.



16' tall telescoping aluminum flagpole includes a 3" gold aluminum ball ornament, a double flag harness to fly two flags or fly at half mast, a 3' x 5' nylon USA flag with embroidered stars and sewn stripes. Other pole heights available as special order.

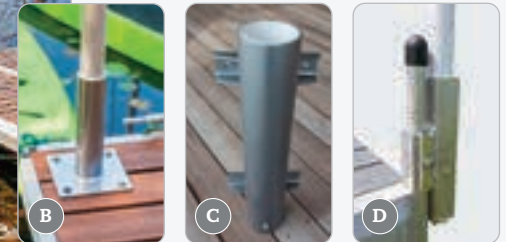

Flag Poles

Style	Suggested Retail	Our Price
A1 Silver Finish 16' Flag Pole	\$ 449	\$ 329
A2 Black Finish 16' Flag Pole	\$ 499	\$ 359
Dock Mounts (for flagpoles)		Our Price
B Deck surface mount		\$ 99
C Side mount		\$ 105
D Pole mount for docks with 1 1/2" leg pipe		\$ 99

SURCHARGE NOTICE: Due to supply issues and cost increases, a 10% surcharge will be applied to all of our printed prices until further notice and is subject to change.

Options & Accessories : Ladders & Steps



Dock Ladders

(available for all dock systems)

One-piece, removable vertical ladder with 1 ½" tubular aluminum frame and arched, slip resistant 4" treads for added comfort with bare feet. Treads are 17½" wide.

Stock Size	PRICE
3' ladder	\$ 279
4' ladder	\$ 299
5' ladder	\$ 319



Shallow Water Stairs

(available for all leg & wheel docks)

One-piece welded aluminum structure with aluminum handrails down each side and non-slip treads with adjustable footpads. 19.50" wide treads/29" between rails/8" risers.

Stair Size	Elevation ¹	PRICE
4 step	37" – 49"	\$ 729
5 step	45" – 57"	\$ 779
6 step	53" – 65"	\$ 829

¹Accommodates elevation from deck surface to lakebed.

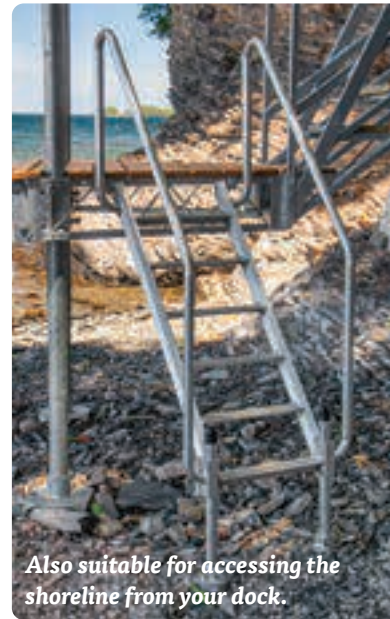

Also suitable for accessing the shoreline from your dock.



SURCHARGE NOTICE: Due to supply issues and cost increases, a 10% surcharge will be applied to all of our printed prices until further notice and is subject to change.



Our lightweight aluminum stair kits are designed to accommodate a variety of applications. Offering a lifetime of virtually maintenance free features, these quality aluminum stairs are an economical solution for waterfront or hillside access and ideal for replacing your old wooden steps. Not recommended for in-water use.

Aluminum Stair Features

- Readily available in lengths up to 18'
- Non-skid, 28" wide aluminum stair treads
- Rounded aluminum handrails on both sides
- Adjustable rise & run (27 to 44 degrees) to accommodate your site
- Marine grade aluminum extrusions with stainless steel fasteners (not recommended for in water use)
- Lightweight & easy to carry for a two-person installation
- Custom fabrication available for specific applications & lengths (see custom catalog or our website)
- Optional adjustable footpads for base of stairs
- Includes mounting bracket (designed for easy seasonal installation & removal of stairs)



Waterfront Access : Aluminum Stairs

Calculate shipping costs on our website at:

www.thedockdoctors.com/stair-kits



Muskegon, MI

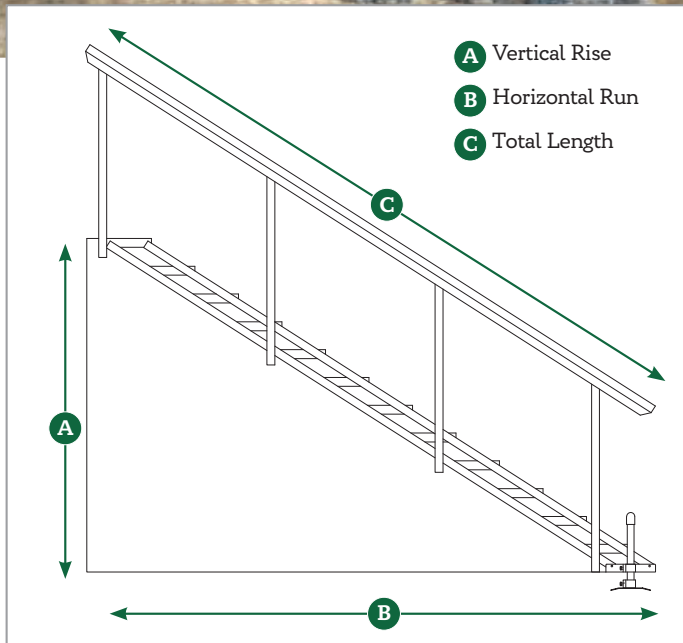

 4 and 6-step
stairs ship
UPS ground

 8 thru 16-step
stairs ship
freight



4-step

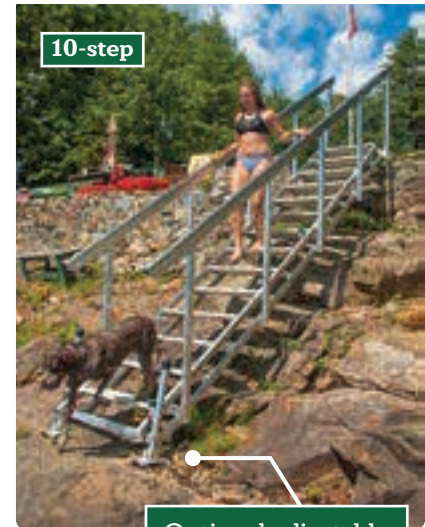

10-step

Optional adjustable
footpad for uneven
surfaces.



How to measure for stairs

A few simple measurements can help determine the recommended length of stairs for your particular site.

For tips on how to measure, visit our website at:

www.thedockdoctors.com/stair-kits

Aluminum Stairs

All stair treads are 28" wide

All stairs can be assembled to fit any distance between the minimum and maximum rise.

# of Steps	Price*	MINIMUM RISE			MAXIMUM RISE			Weight
		Rise @ 6" (27°)	Run with 6" rise	Length with 6" rise	Rise @ 9" (44°)	Run with 9" rise	Length with 9" rise	
4	\$ 869	2' 0"	4' 7"	5' 0"	3' 0"	3' 11"	4' 11"	70 lbs.
6	\$ 1,169	3' 0"	6' 6"	7' 2"	4' 6"	5' 6"	7' 1"	100 lbs.
8	\$ 1,469	4' 0"	8' 5"	9' 4"	6' 0"	7' 1"	9' 3"	122 lbs.
10	\$ 1,769	5' 0"	10' 4"	11' 6"	7' 6"	8' 8"	11' 5"	150 lbs.
12	\$ 2,069	6' 0"	12' 3"	13' 8"	9' 0"	10' 2"	13' 7"	174 lbs.
14	\$ 2,369	7' 0"	14' 2"	15' 10"	10' 6"	11' 9"	15' 9"	202 lbs.
16	\$ 2,669	8' 0"	16' 1"	18' 0"	12' 0"	13' 3"	17' 11"	225 lbs.
n/a	\$ 700	3' x 4' stair platform (standard duty aluminum with aluminum decking)						45 lbs.

*Price includes mounting bracket (fasteners to existing platform not included); handrails down each side and slip resistant stair treads. Stair uprights remain vertical in any rise. Optional top and/or bottom stair platform in 3' x 4' standard duty aluminum. Optional pair of Adjustable Footpads includes brackets to mount to bottom of stairs, 1 1/2" aluminum support pipes 24" long, black safety caps & aluminum footpads. Requires stair frame drilling on-site to mount.

SURCHARGE NOTICE - Due to supply issues and cost increases, a 10% surcharge will be applied to all of our printed prices until further notice and is subject to change.



mounting bracket



rounded aluminum handrail

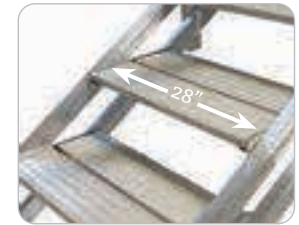

non-skid, 28" wide aluminum stair treads



(optional)

Adjustable Footpad
\$230 / pair

Requires drilling stair on-site to mount.

Assembly Options: Unassembled: Requiring assembly on site to contour to desired rise (note: some drilling is required).

Pre-assembled: Factory assembled and adjusted to desired rise (note: additional assembly charge will apply).

*Prices do not include shipping/delivery. To calculate shipping to your location, please visit: www.thedockdoctors.com/stair-kits

Leg & Wheel Docks : Standard Duty Aluminum



Designed for smaller lakes and bays, our standard duty aluminum frame leg and wheel docks feature an exceptionally strong aluminum frame. Strong yet lightweight, these docks can be installed by one person.



Standard Duty Aluminum Leg & Wheel Docks

- Exceptionally strong aluminum frame
- Support stanchions built into the frame for an obstruction-free dock edge
- Removable decking in cedar, composite – or attached Sure-Step® decking
- Ipe hardwood decking option also available

EASY one person install



Our innovative connector clips and lightweight sections allow for one person to easily connect sections together and install the dock system.



Salisbury, VT

Standard duty aluminum leg dock with composite decking (special order color), shallow water stairs (see page 18) and 4,500 lb. Vertical Boat Lift.

Leg & Wheel Docks : Standard Duty Aluminum



Groton, VT

Standard duty aluminum leg docks with cedar decking and 4,500 lb. Vertical Boat Lift.



Our **freestanding launch port system** can be incorporated into your dock system (see page 58 for more details).



Standard duty aluminum leg docks with Sure-Step decking.



Salisbury, VT

Standard duty aluminum leg dock with cedar decking and our shallow water stairs (see page 18).



Crown Point, NY



Standard Duty aluminum wheel docks easily roll in and out seasonally or as the water fluctuates during the season.

Made in

the USA

Leg & Wheel Docks : Standard Duty Aluminum



Lake Placid, NY

Above & Right: Standard duty aluminum leg dock with cedar decking and our **freestanding launch port system** (see page 58 for more details and pricing).



Watch a video and find out more at:
www.thedockdoctors.com/launch-port

Assembly Components

Connector Clips
for connecting
docks together
\$ 31 set of 2



Safety Cap
for 1 1/2" pipe
\$ 5.75 each



**Aluminum
Pipe 1 1/2"**
cut to length
pending
water depth
\$ 9.50 per foot



Footpad
(aluminum)
\$ 42 each



Cross Braces
(optional)
stabilizes docks
in deeper water
4 foot: **\$ 179**
6 foot: **\$ 189**
8 foot: **\$ 199**
10 foot: **\$ 209**



Size based on distance between support pipe.



Standard Duty Aluminum Leg & Wheel Docks

SURCHARGE NOTICE: Due to supply issues and cost increases, a 10% surcharge will be applied to all of our printed prices until further notice and is subject to change.

Stock Size	Weight*	See decking & color choices on page 8.			
		CEDAR	ALUMINUM	WEARDECK®	SURE-STEP®
		Price	Price	Price	Price
LEG DOCKS					
4' x 8'	49 lbs.	\$ 739	\$ 1,005	\$ 969	n/a
4' x 10'	58 lbs.	\$ 855	\$ 1,169	\$1,125	n/a
4'3" x 8'5"	103 lbs.	n/a	n/a	n/a	\$ 939
4'3" x 10'5"	125 lbs.	n/a	n/a	n/a	\$1,075
WHEEL DOCKS					
4' x 12'	95 lbs.	\$1,429	\$ 1,809	\$ 1,749	n/a
4'3" x 12'5"	149 lbs.	n/a	n/a	n/a	\$ 1,685

Dock pricing includes frame and removable decking. Wheel dock pricing includes (1) pair of wheels and axle assembly. The necessary assembly components are sold separately. *Weights for docks do not include the decking with the exception of docks with Sure-Step® decking, which attaches directly to the dock frame and is not removable.

Leg & Wheel Docks : Medium Duty Aluminum



Our medium duty aluminum frame leg and wheel docks offer superior strength and stability, featuring taller frames and longer and wider sections than our standard duty frames. Easy to install, the support stanchions are built into the frame and flush to the sides of the dock, allowing for an obstruction-free dock edge.



Medium duty aluminum leg docks with WearDeck decking in barefoot grey, vertical fenders and solar post lites.

Medium Duty Aluminum Leg & Wheel Docks

- Exceptionally strong, 7" tall aluminum frame
- Support stanchions built into the frame, for an obstruction-free dock edge
- Removable decking panels in cedar, composite or aluminum
- Ipe hardwood decking option also available

Standard Duty vs. Medium Duty Frames

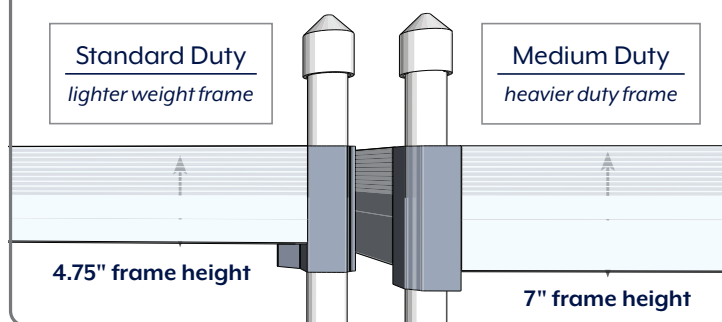

6 foot wide sections optimize deck space

Greensboro, VT

Leg & Wheel Docks : Medium Duty Aluminum



Lake Bomoseen, VT

6' wide medium duty aluminum docks with composite decking (special order color) and 6,000 lb. vertical boat lift with Sunbrella canopy (see pp. 70-73). Accessories include shallow water stairs, vertical fenders and solar post lites.



6' x 10' sections side by side with composite decking and our aluminum stairs (see pages 19-21) for waterfront access.



EASY to install

No sharp edges on underside of frames make our aluminum docks easy on the hands for carrying.



Optional triangle section for more deck space



Vertical Fender and Solar Post Lite

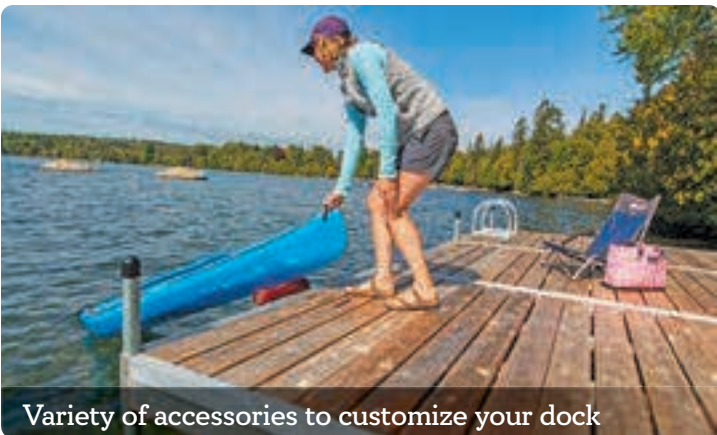

Variety of accessories to customize your dock



WearDeck decking in Barefoot Sand

Greensboro, VT

Main walkway with 4' x 10' sections, then 6' x 10' sections side by side. Shown with vertical fenders, shallow water stairs, cross braces, aluminum ladder and pipe-mounted storage arms. See all our **dock accessories** on pages 10-18).



Hinesburg, VT

Main walkway with 4' x 10' sections, then a 6' x 10' section to create a larger platform.

Leg & Wheel Docks : Medium Duty Aluminum



Above Left: Sections arranged side-by-side to create a waterfront deck area on a site with a steep shoreline.

Above Right: Store your paddle crafts off your dock surface with our pipe-mounted storage arms. See all our **dock accessories** on pages 10-18).

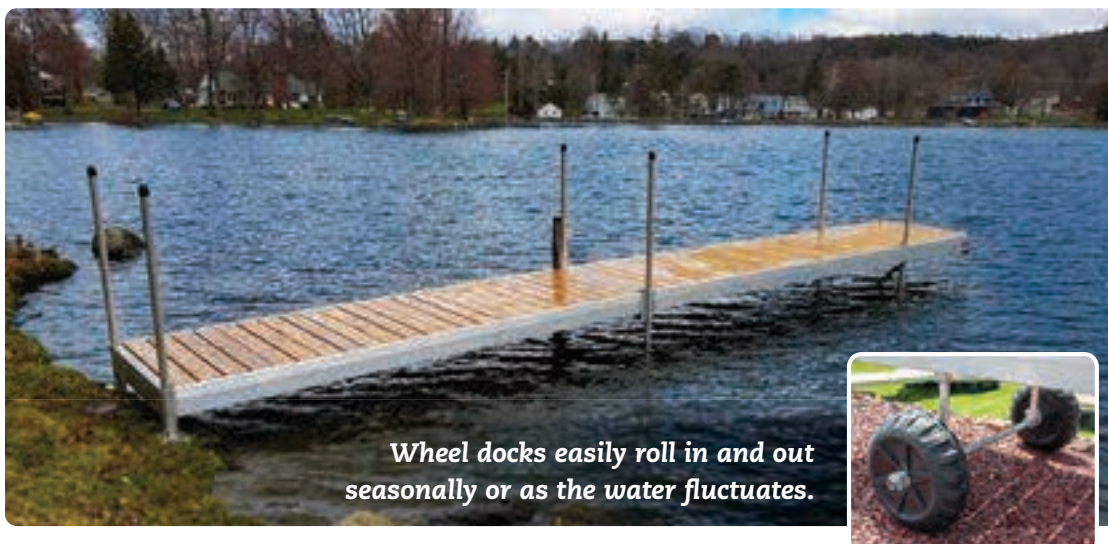

Medium duty aluminum leg docks with aluminum decking. Accessed by our adjustable aluminum stairs (see pages 19-21).

Assembly Components

Connector Clips
for connecting
docks together
\$ 42 set of 2



Safety Cap
for 1 1/2" pipe
\$ 5.75 each



**Aluminum
Pipe 1 1/2"**
cut to length
pending
water depth
\$ 9.50 per foot



**Footpad
(aluminum)**
\$ 42 each



Cross Braces
(optional)
stabilizes docks
in deeper water
4 foot: **\$ 179**
6 foot: **\$ 189**
8 foot: **\$ 199**
10 foot: **\$ 209**



Size based on distance between support pipe.



Medium Duty Aluminum Leg & Wheel Docks

SURCHARGE NOTICE: Due to supply issues and cost increases, a 10% surcharge will be applied to all of our printed prices until further notice and is subject to change.

Stock Size	Weight*	CEDAR	ALUMINUM	WEARDECK®
		Price	Price	Price
LEG DOCKS				
4' x 8'	75 lbs.	\$ 949	\$ 1,195	\$ 1,159
4' x 10'	89 lbs.	\$ 1,085	\$ 1,395	\$ 1,349
4' x 12'	100 lbs.	\$ 1,205	\$ 1,605	\$ 1,529
6' x 8'	93 lbs.	\$ 1,229	\$ 1,589	\$ 1,509
6' x 10'	111 lbs.	\$ 1,409	\$ 1,875	\$ 1,759
6' x 12'	125 lbs.	\$ 1,575	\$ 2,135	\$ 1,995
3' x 3' triangle corner	30 lbs.	\$ 540	\$ 569	\$ 559
WHEEL DOCKS				
4' x 16'	156 lbs.	\$ 2,139	\$ 2,619	\$ 2,529
6' x 16'	184 lbs.	\$ 2,409	\$ 3,159	\$ 2,949

Dock pricing includes frame and removable decking. Wheel dock pricing includes (1) pair of wheels and axle assembly. The necessary assembly components are sold separately. *Weights for docks do not include the decking.

Leg & Wheel Docks : Heavy Duty Steel Truss



Designed for exposed sites and rough water conditions, our heavy duty steel truss leg and wheel docks are incomparable for strength and durability. The heavy duty truss frame allows water to pass through the frame.



Above: Steel truss leg docks with cedar decking and 4,500 lb. vertical boat lift.

South Hero, VT

Heavy Duty Steel Truss Leg & Wheel Docks

- Designed for exposed sites
- Heavy duty 9" galvanized steel truss frame with adjustable leg stanchions built into frame
- Removable decking in cedar or composite
- Ipe hardwood decking option also available
- 10 year limited warranty



Steel truss leg docks with composite decking arranged in a "U" shape to create a boat slip.



Poultney, VT

6' x 10' steel truss leg docks with cedar decking and our 6-step adjustable aluminum stairs

Leg & Wheel Docks : Heavy Duty Steel Truss



Ticonderoga, NY

Above: Steel truss leg docks with WearDeck decking in Barefoot Grey.



3' x 3' triangle corner for more deck space.



Lake Champlain, VT

Steel truss leg docks with cedar decking and 6,000 lb. Vertical Boat Lift. Dock sections "ramp down" for a site that has seasonal water fluctuation.



4' x 16' with "I"

Steel truss wheel docks with WearDeck decking in Barefoot Sand



Above: 2' x 10' catwalk and 6' x 10' leg docks with cedar decking and 1,200 lb. vertical boat lift. **Right:** Lower access platform (see p. 14).



Dock Sections are more manageable with removable decking panels



Shelburne, VT

Leg & Wheel Docks : Heavy Duty Steel Truss



6' wide sections with cedar decking and 5,000 lb. vertical boat lift with Sunbrella Canopy.



Aluminum Stairs (see p. 19-21)



Vertical Fenders (see p. 10-11)



Shallow Water Stairs (see p. 18)



Kayak/Canoe Roller (see p. 15)



Aluminum Ladders (see p. 18)



Storage Racks (see p. 13)

Assembly Components

Connecting Brackets

each connection requires (4)

End-to-end: \$ 17 /ea

Side-by-side: \$ 17 /ea

Catwalk (3"): \$ 15 /ea

catwalk requires (2)

3" brackets & (2) truss end-to-end brackets



Safety Cap

for 1 1/2" pipe

\$ 5.75 each

Galvanized Pipe

1 1/2"

cut to length pending water depth

\$ 9.50 per foot



Footpad

(galvanized steel)

\$ 44 each



Dock Panel Securing Cord

\$ 6 set of 4



Cross Braces

(optional) stabilizes docks in deeper water

4 foot: \$ 179

6 foot: \$ 189

8 foot: \$ 199

10 foot: \$ 209



Size based on distance between support pipe.

4' x 10' Leg Dock
with removable deck panels



4' x 16' Wheel Dock
with removable deck panels



Heavy Duty Steel Truss Leg & Wheel Docks

SURCHARGE NOTICE: Due to supply issues and cost increases, a 10% surcharge will be applied to all of our printed prices until further notice and is subject to change.

Stock Size	Weight*	See decking & color choices on page 8.	CEDAR	WEARDECK®
			Price	Price
LEG DOCKS				
4' x 8'	100 lbs.		\$ 1,099	\$ 1,315
4' x 10'	115 lbs.		\$ 1,184	\$ 1,449
6' x 8'	125 lbs.		\$ 1,425	\$ 1,699
6' x 10'	145 lbs.		\$ 1,509	\$ 1,869
2' x 10' catwalk (std duty**)	75 lbs.		\$ 629	\$ 755
3' x 3' triangle corner	19 lbs.		\$ 389	\$ 419
WHEEL DOCKS				
4' x 16'	208 lbs.		\$ 2,355	\$ 2,745
6' x 16'	265 lbs.		\$ 2,659	\$ 3,199
4' x 16' with 4' x 8' L	316 lbs.		\$ 3,469	\$ 4,049
6' x 16' with 4' x 8' L	373 lbs.		\$ 3,779	\$ 4,469

Dock pricing includes frame and removable decking. Wheel dock pricing includes (1) pair of wheels and axle assembly. The necessary assembly components are sold separately. *Weights for docks do not include the decking. **Catwalk shown top right page 37.

Leg & Wheel Docks : Mega Duty Steel Truss

Designed for use in rough and deep water applications, our mega duty steel truss leg and wheel docks feature taller frames, longer and wider sections, and larger diameter upright supports than our heavy duty steel truss dock systems. Available in two stock sizes (or contact us for custom dock size options).

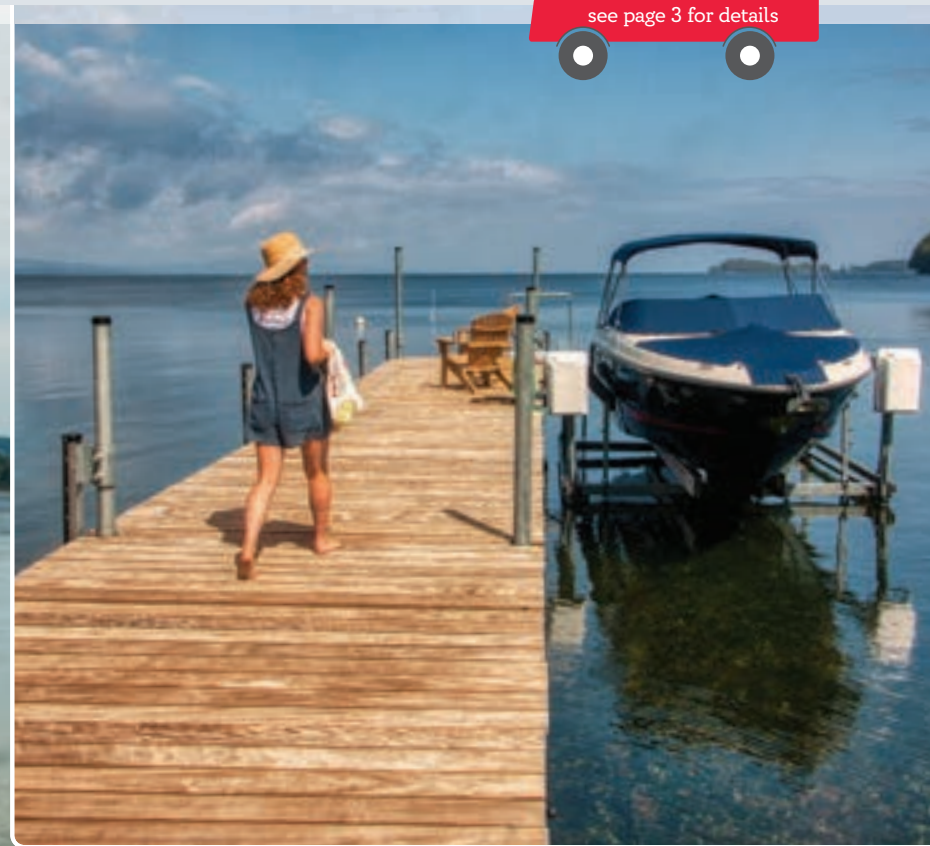
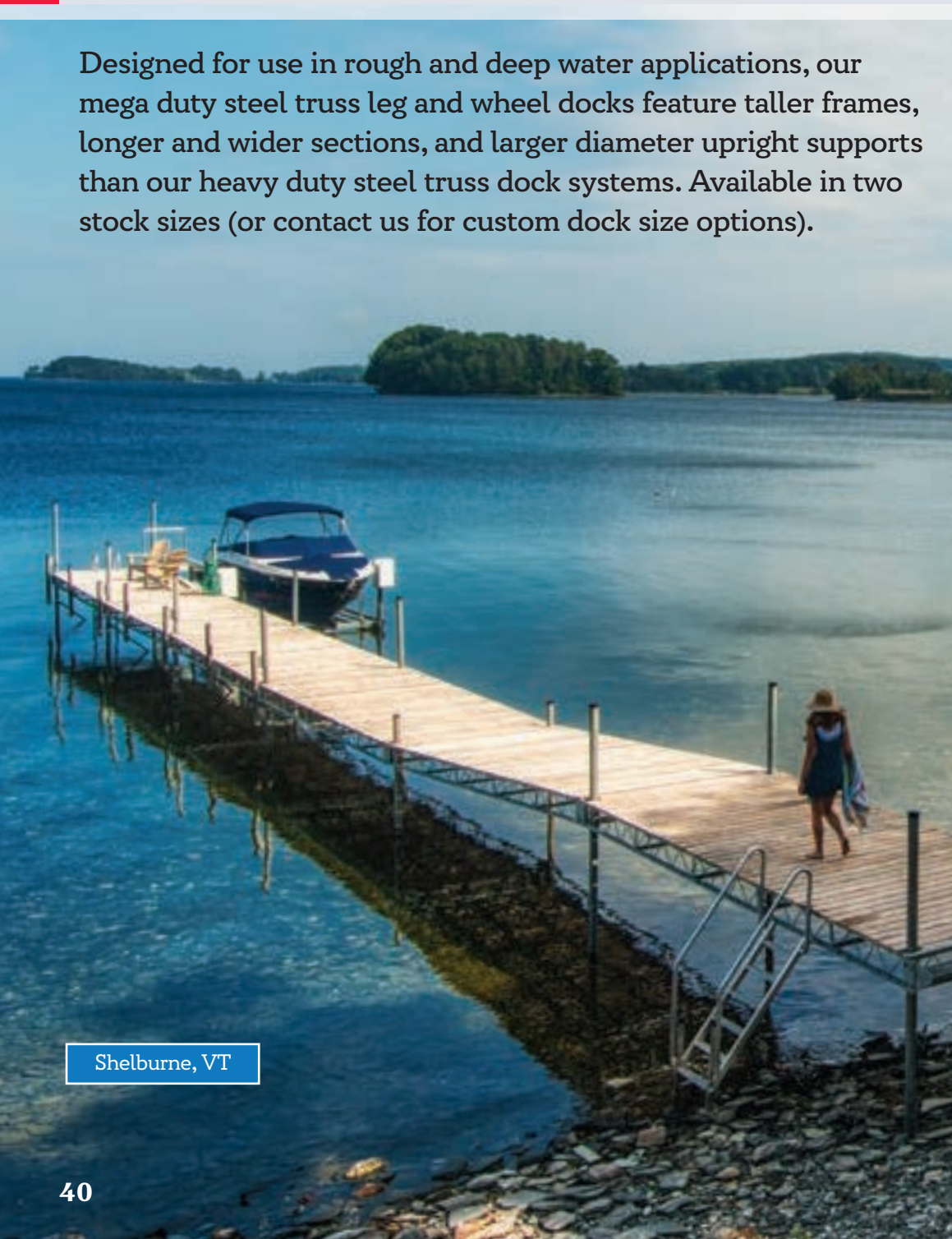

Shelburne, VT

Mega Duty Steel Truss Leg & Wheel Docks

- Designed for use in rough & deep water applications
- 11" tall galvanized steel truss frame
- 3" diameter upright supports
- Stocked in 6' x 20' & 8' x 20' sizes (custom sizes available)
- Adjustable leg stanchions built into frame
- Removable decking in cedar or composite
- Ipe hardwood decking option also available



Heavy Duty vs. Mega Duty Frames

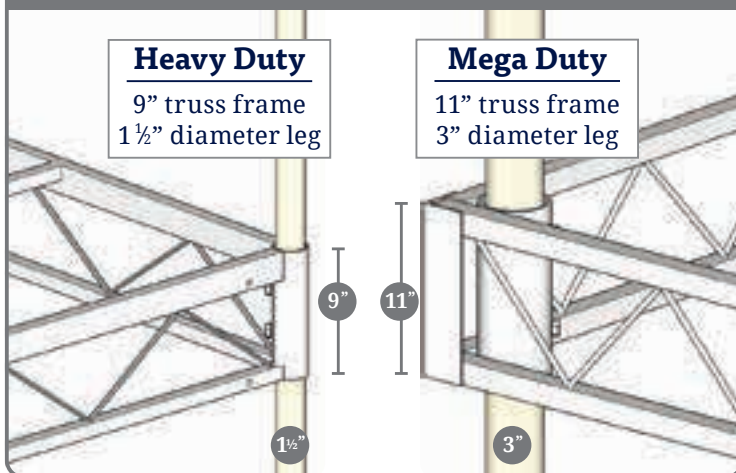

Our sliding boarding step easily slides and retracts so you can safely board your boat from your dock. See page 15 for pricing and details.

Leg & Wheel Docks : Mega Duty Steel Truss

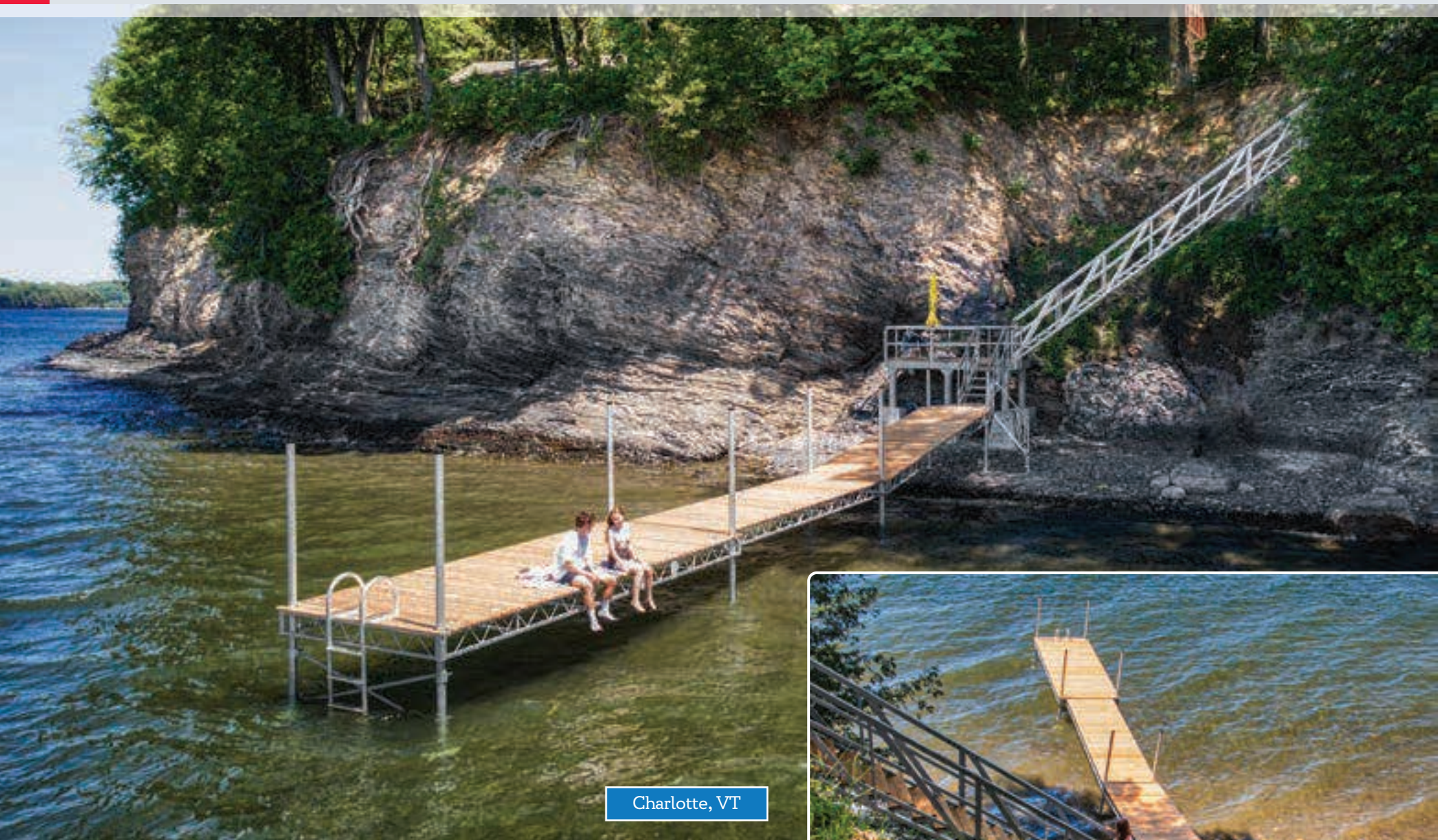

Charlotte, VT

Above: Mega duty leg dock system with our shoreside platform to provide deck space on shore.

Right: Our custom steel stairs provide a safe access for the steep site (see our Custom Catalog pages 36 – 41).

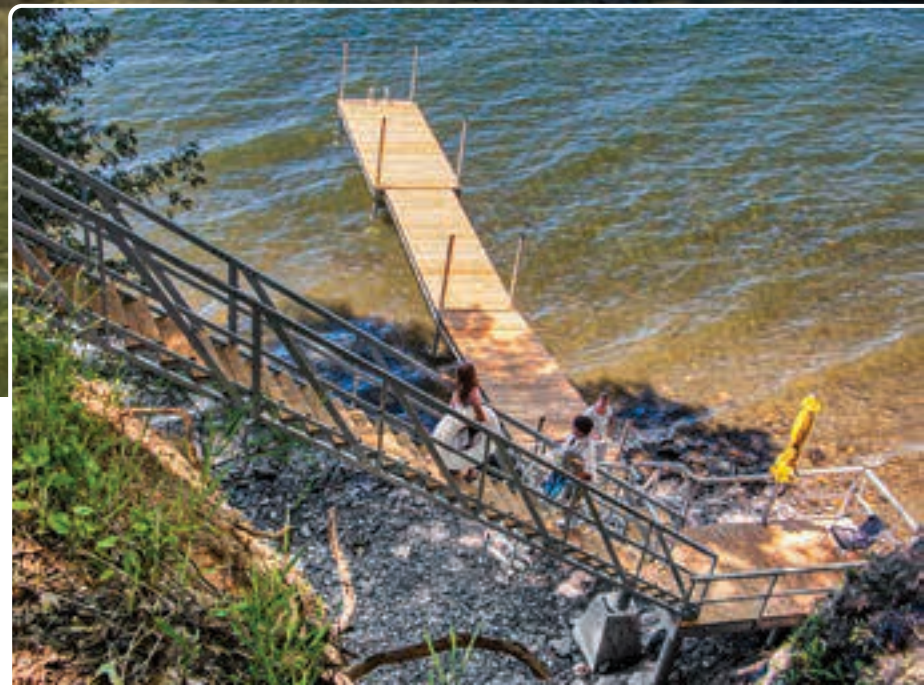



Chazy, NY



Shelburne, VT

Above: Mega dock with WearDeck decking in Barefoot Gray and our Ultimate Boat Lift with a custom fabricated Sunbrella Canopy (see pages 76-79). **Below:** Our aluminum gangway (see page 50-51) serves as access to this mega dock over a rocky shoreline.



Ticonderoga, NY



Hague, NY



Leg & Wheel Docks : Mega Duty Steel Truss



Shelburne, VT

Above & Below Right: Our mega dock used as a shoreside access & mount for a custom floating dock (see our [Custom Catalog](#)).

Below Left: Custom shoreside platform connecting to the Mega Duty steel truss system.

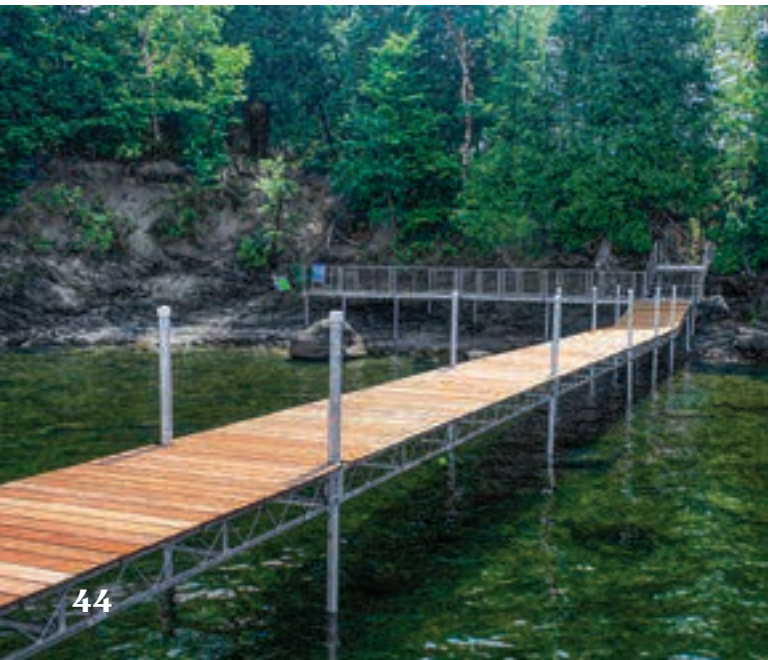

Panton, VT

Assembly Components

Connecting Brackets

each connection requires (4)
\$ 31 each



Safety Cap for 3" pipe

\$ 7.25 each



Galvanized Pipe 3"
cut to length pending water depth
\$ 18 per foot



Footpad (galvanized steel)
\$ 59 each

Dock Panel Securing Cord
\$ 6 set of 4



Cross Braces
(not shown, optional stabilizes docks in deeper water)
\$ 210 (6' wide docks)
\$ 220 (8' wide docks)



Mega Dock Adjustment Kit
adjust the level of your dock with this kit that slides over the 3" leg pipe
\$ 535 pair



Mega Duty Steel Truss Leg & Wheel Docks

SURCHARGE NOTICE: Due to supply issues and cost increases, a 10% surcharge will be applied to all of our printed prices until further notice and is subject to change.

		See decking & color choices on page 8.		
		CEDAR	WEARDECK®	IPE hardwood
Stock Size	Weight*	Price	Price	available as a special order.
LEG DOCKS				
6' x 20'	418 lbs.	\$ 4,589	\$ 5,199	call for quote
8' x 20'	490 lbs.	\$ 6,139	\$ 7,015	call for quote
WHEEL KITS				
for 6' wide docks: \$ 549				
for 8' wide docks: \$ 569				

Dock pricing includes frame and removable decking. Wheel dock pricing includes (2) pairs of wheels and axle assembly. The necessary assembly components are sold separately. *Weights for docks do not include the decking.

Floating Docks : Medium Duty Aluminum



Our medium duty aluminum floating docks feature our “aluminum track” frame, allowing for easy mounting of hardware and accessories. These pre-manufactured “stock” docks are readily available for pick up, delivery or installation and are designed to be easily installed for the do-it-yourselfer.



Schroon Lake, NY

Medium Duty Aluminum Floating Docks

- Used in residential & light commercial applications
- Exclusively designed frame by The Dock Doctors®
- Universal track-style 5" tall aluminum frame allows for easy mounting of hardware & accessories
- Removable decking panels in cedar, aluminum or composite
- Ipe hardwood decking also available
- Black polyethylene flotation filled with expanded polystyrene



Aluminum floating dock with cedar decking. Features a fixed to floating combination of dock styles for use on bodies of water that have fluctuating water levels. The fixed leg dock sections provide a walkway that can accommodate high and low water levels. The transition piece (inset) allows for horizontal movement while the floating dock can float up and down on the anchoring.

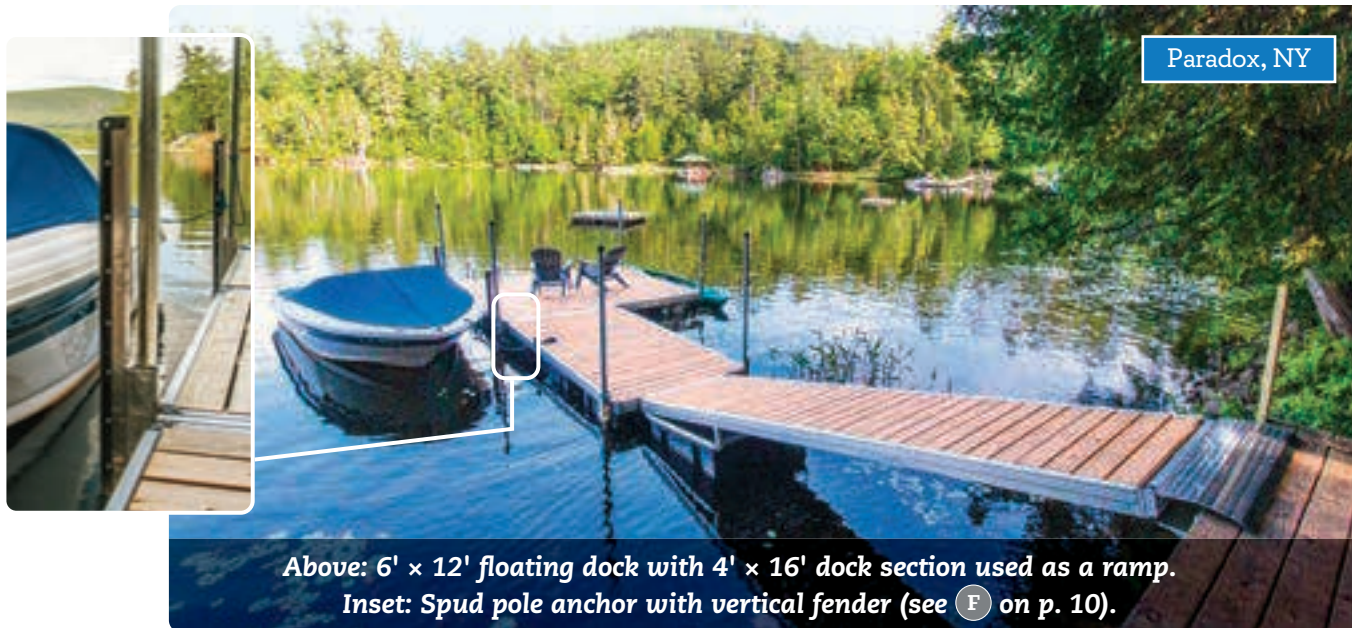

Above: 6' x 12' floating dock with 4' x 16' dock section used as a ramp.
Inset: Spud pole anchor with vertical fender (see **F** on p. 10).

Floating Docks : Medium Duty Aluminum

Shoreham VT



Aluminum floating dock and 3' x 24' aluminum gangway with cedar decking.



Seamless transition from gangway to dock.



Our heavy duty steel truss docks serve as a walkway over a marshy shoreline.



Aluminum Ladder
(see p. 18)



Schroon Lake, NY

Aluminum floating dock with WearDeck composite decking, solar post lights, and vertical fenders. 4' x 16' dock section used as a ramp.



Ludlow, VT



Plymouth, VT

Floating Docks : Medium Duty Aluminum

Aluminum floating dock and gangway with WearDeck® decking in barefoot grey. Anchored with our chain tube anchor mount (inset) and our custom pile dock as a shore hitch.



Our heavy duty aluminum docks with a 7" tall frame are ideal for sites with more exposure (see pages 4-5 & 51-53 in our Custom Catalog).



Our unique float frame and hinge-system allow for a seamless transition from gangway/ramp to dock (no step down) & adjusts to fluctuating water levels.



Assembly Components

Hinge Connector Kits

Hinge connector kits include bushing, stainless steel pins, wear and dampener system and protective cap (cap not shown).



\$ 198
(for 4' wide docks)

\$ 204
(for 6' wide docks)

\$ 210
(for 8' wide docks)



Anchor Mounts:
Spud Pole \$ 269
pipe sold separately



2" Galvanized Pipe
\$ 14 / ft.



Chain Tube \$ 145
chain for anchoring
sold separately

3/8" Galvanized Chain
\$ 4.⁹⁵ / ft.

4' x 12' Medium Duty
Aluminum Floating Dock
with removable deck panels



Medium Duty Aluminum Floating Docks

SURCHARGE NOTICE: Due to supply issues and cost increases, a 10% surcharge will be applied to all of our printed prices until further notice and is subject to change.

Stock Size	Weight*	See decking & color choices on page 8.	ALUMINUM	WEARDECK®
		CEDAR	Price	Price
FLOATING DOCKS				
4' x 12'	200 lbs.		\$ 1,895	\$ 2,179
4' x 16'	260 lbs.		\$ 2,379	\$ 2,749
6' x 12'	256 lbs.		\$ 2,559	\$ 2,929
6' x 16'	368 lbs.		\$ 3,209	\$ 3,699
8' x 12'	352 lbs.		\$ 3,159	\$ 3,679
8' x 16'	503 lbs.		\$ 3,899	\$ 4,599
RESIDENTIAL GANGWAY			CEDAR	ALUMINUM
3' x 24'	357 lbs.		\$ 4,019	\$ 4,369

COMMERCIAL GANGWAYS available in any length/width with minimal time frames.

Pricing includes frame, decking and flotation. Anchoring, connecting hardware and shore mount sold separately. Note: Docks used as a shore ramp may require adjustable float frame and shore connection pending layout. Ipe hardwood decking option available. *Weights do not include the decking.

Floating Docks : Heavy Duty Aluminum Paddle Docks

Featuring heavy-duty aluminum frames, our paddle docks are suitable for commercial or residential applications. Their modular design allow for a variety of layout options.



Osetah Lake, NY

Heavy Duty Aluminum Paddle Docks

- 7" Aluminum Track Frame with 10"- 12" freeboard (approximate – pending sections, size & decking choices)
- Heavy duty, stainless-steel connection hinges
- Optional powder coated frame
- Cedar decking, or upgrade to optional Ipe or composite
- Black polyethylene flotation filled with expanded polystyrene
- Optional marine-grade black vinyl edge fender



Optional angled ladder



Spud pole anchor example



Lake Placid, NY

Above: Paddle dock with composite decking and black powder coated frame.



Above: 10' x 20' paddle dock and 8' x 16' ramp section with Ipe decking.

Paddle Docks		Heavy Duty Aluminum
SURCHARGE NOTICE: Due to supply issues and cost increases, a 10% surcharge will be applied to all of our printed prices until further notice and is subject to change.		
Standard Size	Price	
8' x 20'	as low as \$7,069	
10' x 20'	as low as \$8,625	
8' x 16' ramp section	as low as \$5,395	
Angled Dock Ladder (aluminum)	\$ 469	
Custom sizes and wider ramps available. Standard pricing includes aluminum frame, cedar decking and flotation. Site conditions, exposure, anchoring details and ramp requirements to be determined for final pricing.		



Floating Docks : Heavy Duty Aluminum Rowing Docks

Our heavy-duty, aluminum-frame rowing docks feature a modular design that allows for a variety of layout options. Suitable for commercial or residential applications.

Our aluminum frame rowing dock with 38' x 7' aluminum gangway and our ADA accessible commercial launch with ADA transfer platform.

City of Dover,
Cocheco River, Dover, NH

- 7" Aluminum Track Frame with 6"- 8" freeboard
- Heavy duty, stainless-steel connection hinges
- Modular track-style frame allows easy addition of optional components and multiple layout options
- Black polyethylene flotation filled with expanded polystyrene
- Cedar decking, or upgrade to optional Ipe or Composite
- Optional marine grade black vinyl edge fender
- Optional debris diverter protects the dock from floating debris often seen in river settings



Rowing Docks

Heavy Duty Aluminum

SURCHARGE NOTICE: Due to supply issues and cost increases, a 10% surcharge will be applied to all of our printed prices until further notice and is subject to change.

Standard Size	Price
8' × 20'	as low as \$7,069
10' × 20'	as low as \$8,625
8' × 16' ramp section	as low as \$5,395
8' × 20' flared ramp section	as low as \$7,185

Custom sizes and wider ramps available. Standard pricing includes aluminum frame, cedar decking and flotation. Site conditions, exposure, anchoring details and ramp requirements to be determined for final pricing.

Accessories & Options	Price
A Wheel Kit	\$ 999 / set
B Angled Dock Ladder (aluminum)	\$ 469
C Debris diverter (8' or 10' long)	starting at \$3,345
D Hinge connections	as low as \$409
E Edge Fender (installed on dock)	\$12.⁵⁰ / lineal foot



Saratoga Springs, NY



YMCA Camp Coniston
Grantham, NH

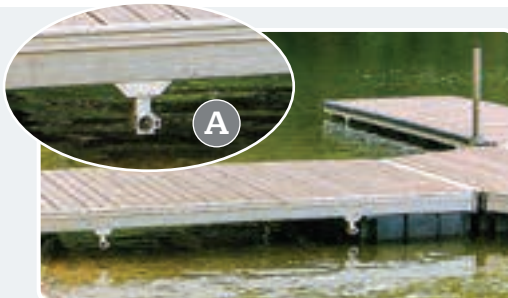

Axle & Wheel Mounts for seasonal installation & removal



Angled Ladder



Debris Diverter



Hinge Connections

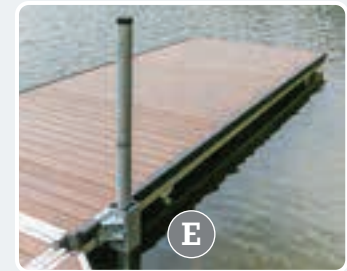

Edge Fender

Paddle Craft Launch Docks: Residential & Commercial Floating Launch Docks



Residential Dock & Launch Systems Our medium-duty aluminum floating launch system can be used as an independent launch dock, or as part of a complete dock system.

Find out more at: www.thedockdoctors.com/dock-and-launch-residential

Dock & Launch System

Medium Duty Residential

SURCHARGE NOTICE: Due to supply issues and cost increases, a 10% surcharge will be applied to all of our printed prices until further notice and is subject to change.

Featuring a 5" tall aluminum frame, and 19' x 11'9" overall size, our medium duty dock and launch system includes:

- A** (1) main frame (7' x 11' 9")
- B** (2) dock fingers (12' x 3' 6")
- C** Launch ramp (4' x 12')
with built-in rollers & Sure-Step® non-skid decking
- D** Boarding handle
- E** Grab and launch rails

* as low as \$ 14,950

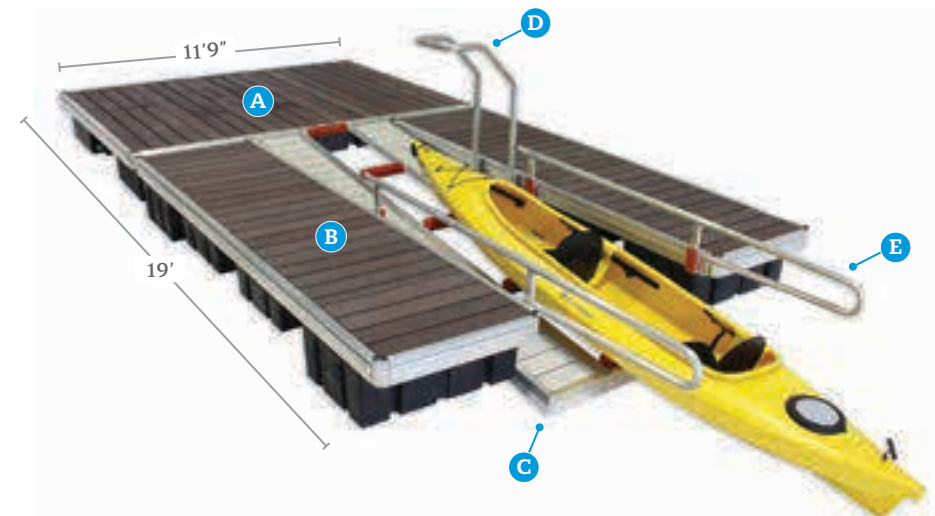

*Site conditions, anchoring & decking selection are necessary to determine final pricing. Please call for a free estimate.

Commercial Dock & Launch Systems

- Heavy-duty system meets commercial & municipal quality standards with a 7" universal track-style frame.
- Can be used as a complete floating dock system, integrated into existing systems, or in conjunction with any of our floating dock systems.
- Features boarding handle and grab and launch rails. Non-skid surface on the launch platform.
- Optional transfer platform for wheelchair to craft access.
- Optional ADA curbing and rails.
- Watch a video and learn more at: thedockdoctors.com/commercial-launch



Dock & Launch System

Heavy Duty Commercial

SURCHARGE NOTICE: Due to supply issues and cost increases, a 10% surcharge will be applied to all of our printed prices until further notice and is subject to change.

Featuring a 7" tall aluminum frame, and a 20'3" x 19' overall size, our heavy duty commercial dock and launch system includes:

<ul style="list-style-type: none"> A (1) main frame (7' x 19') B (2) dock fingers (7' x 13' 4") C Launch ramp (4' 4" x 15') with built-in rollers & Sure-Step® non-skid decking 	<ul style="list-style-type: none"> D Boarding handle E Grab and launch rails
---	--

* as low as \$ 23,500

*Site conditions, anchoring & decking selection are necessary to determine final pricing. Please call for a free estimate.

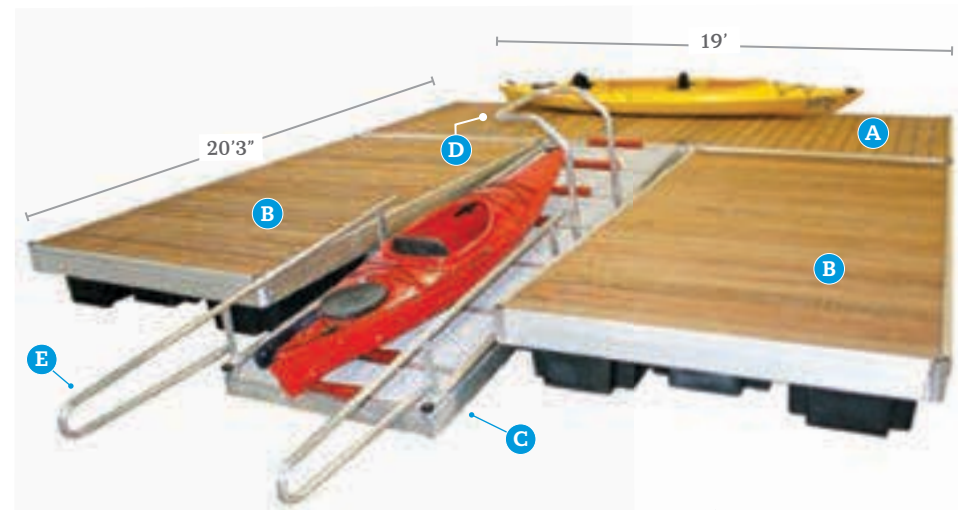

Paddle Craft Launch Docks & Lifts : Easily board & launch your paddle craft



- Ideal for controlled bodies of water with minimal fluctuation
- Fixed height non-skid Sure-Step® platform
- Non-marring Stoltz® rollers
- Custom layouts available by adding more leg dock sections
- Optional grab and launch rails offer more control when gliding on and off the launch platform



A Boarding Handle (optional)

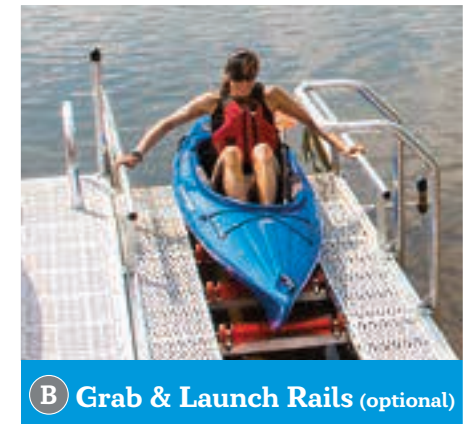

B Grab & Launch Rails (optional)

Freestanding Launch Port System

Easily board and launch your craft with our freestanding Launch Port System. Ideal for controlled bodies of water with minimal water fluctuation, the launch system is at a fixed level. Includes (2) standard duty leg dock sections and launch ramp. Custom layouts available for your specific site.

SURCHARGE NOTICE - Due to supply issues and cost increases, a 10% surcharge will be applied to all of our printed prices until further notice and is subject to change.

Freestanding Launch Port Standard Duty Aluminum

Base unit includes:
(1) 4' × 8' & (1) 4' × 10' standard duty leg dock sections and (1) 4' × 12' launch ramp.

SURE-STEP®	
Item	Price
Freestanding Launch Port System	\$ 5,325
A Boarding handle (optional)	\$ 379
B Grab & launch rails (optional)	\$ 639

Pipe for upright supports sold separately pending water depth and lengths required.

Launch Port Lift

If your water levels fluctuate, our Launch Port Lift raises up to 75" so the water is never out of reach.

- Non-marring Stoltz® rollers
- Non-skid Sure-Step® platform
- Stainless steel fasteners & cables
- 30" handwheel raises & lowers the platform
- 18" adjustable legs (other lengths available)
- Assembly service available (additional fee)



Launch Port Lift Specs

Lifting Height	75"
Overall Width	73"
Overall Length	144"
Weight with platform	400 lbs.

Launch Port Lift

Item	Price
Launch Port Lift (unassembled)	\$ 6,450
A Boarding Handle (optional)	\$ 379
B Grab & Launch Rails (optional)	\$ 639

SURCHARGE NOTICE - Due to supply issues and cost increases, a 10% surcharge will be applied to all of our printed prices until further notice and is subject to change.

Watch a video and find out more at: thedockdoctors.com/launch-port-lift



A Boarding Handle (optional)

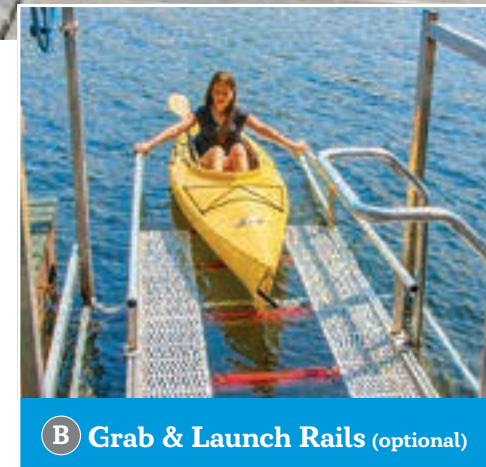

B Grab & Launch Rails (optional)

Paddle Craft Lift : Residential small craft lifts



Our innovative Kayak Lift & Launch features a platform that raises and lowers so you can safely and easily launch your kayak from a seawall or dock.

- Mounts to seawalls or docks
- Manual winch raises and lowers the platform
- Sure-Step® UV resistant decking on platform
- Boarding handle with built-in paddle storage hooks
- Adjustable aluminum & vinyl bunks
- Three models available
- FREE UPS shipping on models KL100-30 & KL100-66L
- Model KL400-72L ships freight visit our website for shipping costs to your location

Kayak Lift & Launch Specifications & Pricing

MODEL	A KL100-30	B KL100-66L	C KL400-72L
Lifting Height	30"	66"	72"
Max Craft Weight	100 lbs.	100 lbs.	400 lbs.
Max Craft Beam Width	38"	38"	51"
Ladder	NO	YES	YES
 UPS Shippable*	YES	YES	NO (ships freight)
PRICE	\$2,099	\$2,679	\$3,669

SURCHARGE NOTICE: Due to supply issues and cost increases, a 10% surcharge will be applied to all of our printed prices until further notice and is subject to change.

*FREE shipping on KL100-30 and KL100-66L within the continental USA. Shipping additional for Model KL400-72L, please call or visit our website to calculate a shipping cost to your location. Custom lifting heights available, call us for details.



Watch a video of the kayak lift at:
www.thedockdoctors.com/ladder-lift-launch



Lower launch platform and craft.



Transition down the ladder.



Board your craft.



Glide smoothly off.

FREE shipping



A

Photo courtesy of M. Warkentin

For sites that are a minimal distance off the water, model KL100-30 Kayak Launch has a lifting height of 30" and can accommodate crafts up to a 38" beam width. Includes manual winch, boarding handle, kayak leash and adjustable bunks.

\$2,099  Ships FREE within the continental USA

FREE shipping



B

Model KL100-66L features a built-in ladder and has a lifting height of 66" and can accommodate crafts up to 38" beam width. Includes manual winch, boarding handle, kayak leash and adjustable bunks.

\$2,679  Ships FREE within the continental USA



C

This model accommodates the Hobie Mirage® Tandem



Designed for larger crafts the KL400-72L Kayak Launch features a built-in ladder and has a lifting height of 72" and can accommodate crafts up to 51" beam width. Includes manual winch, boarding handle, kayak leash and adjustable bunks.

\$3,669  Ships FREIGHT (shipping additional)

Optional Accessories



Kayak Roller: Assists in moving your kayak onto the bunks. Bolts to side of platform. Cannot be used in combination with Top Transition Step. \$209



Top Transition Step: Provides a platform for an easier transition to the ladder or the launch platform. Also assists with loading and unloading your craft. \$329



Concrete Installation Kit: For installation on concrete surface. Note: Requires an electric hammer drill with concrete bit sized for the rod listed.

KL100 kit: \$110

KL400 kit: \$119

SURCHARGE NOTICE: Due to supply issues and cost increases, a 10% surcharge will be applied to all of our printed prices until further notice and is subject to change.

Paddle Craft Storage Racks : Accessories for storing your paddle crafts

Marine-grade aluminum frame small craft storage racks. Available in freestanding, wall mounted, and dock mounted styles. Featuring arms with vinyl hull guards and end caps with built-in tie-down openings. Crafts can be secured with a cable and lock (not included).



B

Shipping Available

SURCHARGE NOTICE: Due to supply issues and cost increases, a 10% surcharge will be applied to all of our printed prices until further notice and is subject to change.

Residential Aluminum Storage Racks

- Lightweight aluminum frame storage racks for storing multiple canoes, kayaks, paddle boards and other small crafts
- Adjustable height arms with vinyl hull guards (additional arms available for custom configurations)
- Custom end caps with built-in tie down openings (tie-downs sold separately)
- Stainless steel hardware

Optional Accessories



E

Adjustable Feet

Ideal for uneven ground. Includes 2 feet, mounting brackets and hardware.
\$189 (pair)



F

Additional Support Arms

Includes 2 arms, mounting brackets and hardware.
\$132 (pair)



G

Tie-Down Bungees

Adjustable-length (10 – 48”) with a wrap-and-lock system so you can adjust the tension without unclipping the ends.
\$24 (pair)

adjustable arms with eye-bolts for securing tie-downs

end caps with built-in tie-down openings and vinyl hull guard to protect your craft



Storage Racks

MARINE GRADE
ALUMINUM

SURCHARGE NOTICE: Due to supply issues and cost increases, a 10% surcharge will be applied to all of our printed prices until further notice and is subject to change.

Storage Rack Style	Craft Capacity	Unit Weight	(W × D × H) Dimensions	Arm Length	PRICE
A Double-Sided Rack	6-crafts	102 lbs.	80" × 69" × 67"	35"	\$ 1,069
B Single-Sided Rack	3-crafts	76 lbs.	49" × 69" × 67"	35"	\$ 799
C Mini Rack (double-sided)**	3-crafts	42 lbs.	43" × 56" × 38"	upper 34" lower 18"	\$ 559
D Wall-Mounted Rack	3-crafts	44 lbs.	var.† × 38" × 84"	35"	\$ 595
E Adjustable Feet (pair)	n/a	10 lbs.			\$ 189
F Additional Arms (pair)††	n/a	8 lbs.		35"	\$ 132
G Tie-Down Bungees (pair)	n/a	n/a			\$ 24

All racks include allen wrench for assembly and adjustment of arm positions. Shipping or Delivery additional - please call for pricing or visit our website. *Assembly service available (additional charge) for racks that are picked-up or delivered only. **Double-sided mini rack is designed as a space saver and requires crafts to be positioned slightly angled on the bottom of the rack. †Wall mount rack dimensions are as follows: Width is variable depending upon installation, Depth is from wall to end of arm. ††Additional arms not available for (C) Mini Rack.

Note: Paddle craft should be stored upside-down to prevent collection of water inside the craft.

Paddle Craft Storage Racks : Structurally designed for commercial use



Commercial Storage Racks

Our commercial / municipal storage racks are manufactured with marine-grade aluminum frames and are available in standard aluminum or black powder coated finish.

- Adjustable height arms with vinyl hull guards
- Custom end caps with built-in tie-down openings (tie-downs sold separately)
- Additional arms available
- Standard aluminum or optional black powder coated finish
- Freestanding and concrete mount models
- We can customize any of our storage racks for your specific needs

Commercial Storage Racks

STANDARD ALUMINUM

POWDER COATED BLACK

SURCHARGE NOTICE: Due to supply issues and cost increases, a 10% surcharge will be applied to all of our printed prices until further notice and is subject to change.

Storage Rack Style	Storage Capacity	Unit Weight	(W × D × H) Dimensions	Arm Length	PRICE	PRICE
A Freestanding (Double-Sided)	8-crafts	221 lbs.	93" × 69" × 83"	35"	\$ 2,219	\$ 2,799
B Concrete Mount	8-crafts	172 lbs.	76" × 69" × 72"	35"	\$ 2,079	\$ 2,629
C Additional Arms (pair) ^{††}		18 lbs.		35"	\$ 295	\$ 355

All racks include allen wrench for assembly and adjustment of arm positions. Shipping or delivery additional - please visit our website or call for pricing. * Assembly service available (additional charge) for racks that are picked-up or delivered only. Note: Concrete bases not included.

Note: Paddle craft should be stored upside-down to prevent collection of water inside the craft.

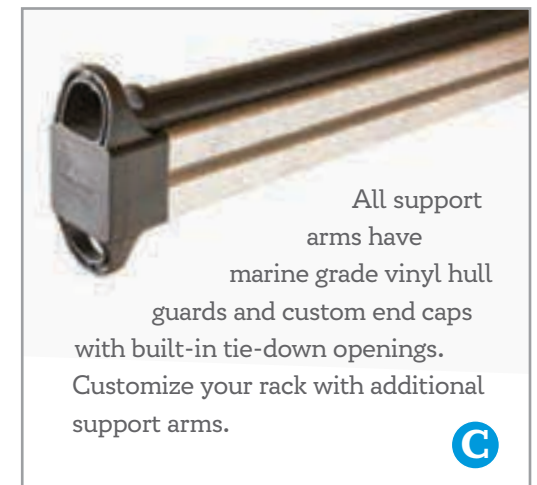

All support arms have marine grade vinyl hull guards and custom end caps with built-in tie-down openings. Customize your rack with additional support arms.

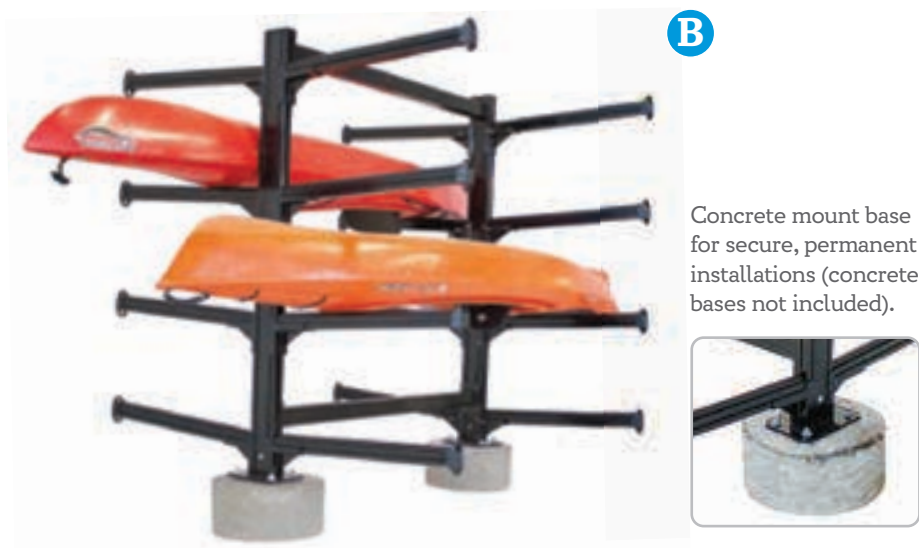

Paddle Craft Trailer : 4' × 5' aluminum trailer for transporting your paddlesport gear

Our Aluminum Paddlesport Trailer is fully-assembled and manufactured with marine-grade, one-piece aluminum frames. Our high-quality, easy to tow, functional trailer will safely transport and store all of your paddling gear.



SURCHARGE NOTICE: Due to supply issues and cost increases, a 10% surcharge will be applied to all of our printed prices until further notice and is subject to change.

4' × 5' Deluxe Trailer

\$2,539

4' × 5' Deluxe Trailer

with standard height removable load bars
model # T45DSS

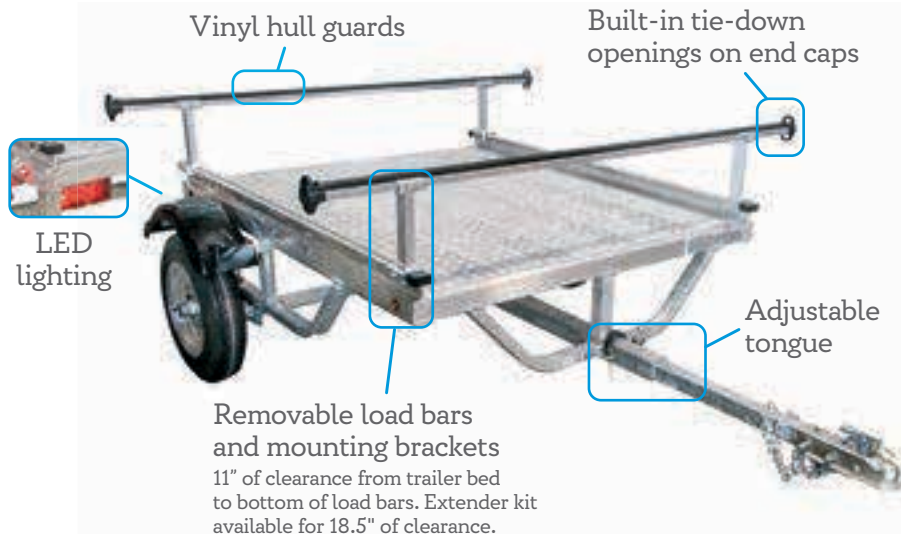

Shipped assembled - prices do not include shipping.

Axle	torsion
Load Bar Length	72"
Coupling Size	2"
Tire Size	12"
Unloaded Weight	250 lbs.
GVWR maximum operating weight	900 lbs.
Load Capacity	650 lbs.
Overall Length	11' 7" tongue extended
	8' 7" tongue retracted
Bed Height	24" ground clearance
	11" load bar clearance



LED lighting



Load bars with custom end caps with built-in tie-down loops & vinyl hull guard included



Adjustable tongue



Sure-Step® decking on trailer bed



SURCHARGE NOTICE: Due to supply issues and cost increases, a 10% surcharge will be applied to all of our printed prices until further notice and is subject to change.

Optional Accessories



Trailer Sideboards

Turn your trailer into a full utility trailer with these removable, marine-grade aluminum sideboards. Sideboards are 16" high from the trailer bed and include brackets for mounting load bars. **\$539**

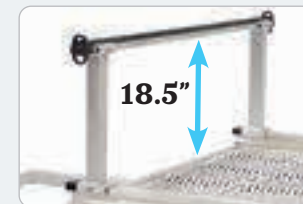

Optional Load Bar Extender Kit



Stands up for storage



We ship our trailers to anywhere in the continental US



Load Bar Extender Kit

This kit raises the load bars from 11" to 18.5" above the trailer bed, allowing room for more gear. **\$195**



Spare Tire and Mount

DOT approved two-ply 12" trailer tire with tongue mount. **\$169**

Boat Lifts : PWC Lifts & Drive On Ports



PWC & Small Craft Lifts

- 1,000 lb. & 1,200 lb. capacity cantilever models
- Stainless steel hardware & cables
- Polymer pulley sheaves prolong cable life
- Dual mounting winch (left or right side)
- 15 Year Limited Warranty
- 1,250 lb. vertical & 2,000 lb. hydraulic models also available (see Vertical Lift section on p. 71 or Hydraulic Lift section on p. 74)
- Manufactured by RGC®



Ideal for all types of smaller watercraft.

Model Capacity	PL1000 1,000 lbs	PL1200 1,200 lbs
Max. Beam	64"	70"
Lifting Height	46"	46"
Bed Length	72"	96"
Min. Water Depth	9"	10"
Overall Width	72"	80"
Adjustable Legs	(4) @ 18"	(4) @ 18"
Shipping Weight	155 lbs	257 lbs
Price (assembled)	\$ 2,075	\$ 2,709
Price (unassembled)	\$ 1,930	\$ 2,565

SURCHARGE NOTICE: Due to supply issues and cost increases, a 10% surcharge will be applied to all of our printed prices until further notice and is subject to change.



Boat Lifts : Boat Access & Seasonal Service Tools

Sliding Boarding Step

SURCHARGE NOTICE: Due to supply issues and cost increases, a 10% surcharge will be applied to all of our printed prices until further notice and is subject to change.



Dock mounted sliding boarding step that bridges the gap between your dock and your boat. Easily slides and retracts so you can safely board your boat from your dock. Extends approximately 20" depending on the mounting location on the dock and includes a safety handrail that mounts to either side of the platform. Great for people AND pets! **\$ 1050** (ships UPS ground)



Shipping Available

Boat Lift Installation & Removal Tools

Make the seasonal installation and removal of your boat lift easier with a wheel kit and/or air bag lift system.

Boat Lift Wheel Kits

Specifically designed for use with RGC® boat lifts and can be modified for use with hydraulic boat lifts. Includes a pair of welded galvanized steel mounting brackets and a pair of heavy duty polyethylene wheels (BLW5075 kit comes with 4 wheels).

BLW2045 (fits 2,000 - 4,500 lb. lifts): **\$ 375 / pair**

BLW5060 (fits 5,000 - 6,000 lb. lifts): **\$ 390 / pair**

BLW5075 (fits 5,000 - 8,000 lb. lifts): **\$ 545 / pair**



Air Bag Lift Kits

Inflatable 250 and 500 lb. capacity air bags designed to float your boat lift for seasonal installation and removal. Ideal when used in conjunction with a wheel kit (see photo on left).

250 lb. capacity: **\$ 315 / airbag**

500 lb. capacity: **\$ 440 / airbag**

Each kit includes (1) airbag, with a connecting kit (carabiner and strap). Airbag inflates with air compressor with a standard 1/4" NPT air fitting.

Boat Lifts : Vertical Lifts



4500 lb. boat lift

Vertical boat lifts for any size and style boat:

- All stainless steel hardware & cables
- High lifting range
- Minimal water required
- Manufactured by RGC®
- 15 year limited warranty
- Delivery & installation available

Below: 8000 lb. boat lift with double bunks for larger boats. Shown with optional canopy (see page 73).

2000 lb. & 1250 lb. boat lifts with higher lifting heights from the regular cantilever PWC lifts to accommodate smaller crafts in exposed areas.



SURCHARGE NOTICE: Due to supply issues and cost increases, a 10% surcharge will be applied to all of our printed prices until further notice and is subject to change.

Aluminum Vertical Boat Lifts

Model #	Weight Capacity	Max. Beam	Overall Width	Overall Length	Lifting Height †	Min. Water	Shipping Weight	Dock Doctors Price (assembled)	Dock Doctors Price (unassembled)
VL1250*	1,250 lbs	65"	73"	82"	75"	8.5"	233 lbs	\$ 3,520	\$ 3,250
VL20100	2,000 lbs	100"	108"	100"	66"	9.5"	249 lbs	\$ 4,885	\$ 4,470
VL45108	4,500 lbs	108"	116"	116"	68"	8"	507 lbs	\$ 7,345	\$ 6,795
VL45116	4,500 lbs	116"	124"	116"	68"	8"	510 lbs	\$ 7,580	\$ 7,030
VL45116 T	4,500 lbs	116"	124"	116"	80"	8"	523 lbs	\$ 7,805	\$ 7,255
VL50124 T	5,000 lbs	124"	133"	132"	80"	9"	597 lbs	\$ 8,370	\$ 7,820
VL60124 T	6,000 lbs	124"	133"	132"	80"	9"	663 lbs	\$ 8,825	\$ 8,200
VL80124 T***	8,000 lbs	124"	133"	132"	78"	11"	777 lbs	\$ 13,180	\$ 12,425
VL100132***	10,000 lbs	132"	147"	158"	78"	13"	1217 lbs	\$ 19,900	\$ 19,300

All pricing is F.O.B. our facility in Ferrisburgh, VT. Prices are for in stock product only. Additional freight charges may apply for special orders. Boat lift prices include (4) adjustable 29" legs with footpads and carpeted pressure treated bunks. Manual handwheel is included with non-electric models. *Lift includes 18" legs. **Add desired pontoon or tritoon kit to the lift models as shown on page 73. †***Lifts include AC Direct Drive with remote control and double carpeted wood bunks.
 † Measured from top of load tubes to bottom of feet when adjustable legs are fully retracted. Measurements are approximate.



We can even deliver your boat lift assembled



note: wide load fee applies.

See page 73 for pricing and details on the pontoon and tritoon cradle kits.



4500 lb. boat lift with pontoon cradle kit



6000 lb. boat lift with tritoon cradle kit

Boat Lifts : Vertical Lift Accessories

A Vertical Lift Guides & Extension Legs

Lift Models	Aluminum & Carpeted Guides		Other Options	
	regular adjusts from 16"-25 1/2" high	tall adjusts from 25"-34 1/2" high	Ext. Legs 4' pair	Ext. Legs 6' pair
3500	\$ 874	\$ 907	\$ 291	\$ 370
4500	\$ 874	\$ 907	\$ 291	\$ 370
5000	\$ 900	\$ 913	\$ 291	\$ 370
6000	\$ 900	\$ 913	\$ 291	\$ 370
8000	n/a	\$ 946	\$ 291	\$ 370
10,000	n/a	\$1,198*	\$ 381	\$ 426

*Tall guides for 10,000 lb. boat lift adjust 25" - 43 1/2". Credit \$95 for a pair of 29" legs if upgrading to longer extension legs with the purchase of a new boat lift.

SURCHARGE NOTICE:
Due to supply issues and cost increases, a 10% surcharge will be applied to all of our printed prices until further notice and is subject to change.

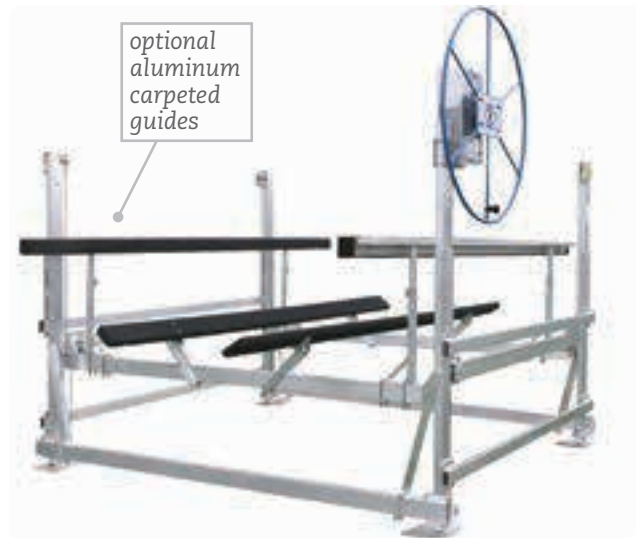

Electric Drive Units

Lift Models	AC Drive Systems				DC Drive Systems		
	B Direct	Direct with remote	Extreme Max Manual	Extreme Max with remote	Direct with remote	Extreme Max Manual	C Extreme Max with remote
3500	\$ 2,122	\$ 2,979	\$ 1,470	\$ 1,855	\$ 3,158	\$ 1,470	\$ 1,855
4500	\$ 2,166	\$ 3,102	\$ 1,470	\$ 1,855	\$ 3,158	\$ 1,470	\$ 1,855
5000	\$ 2,166	\$ 3,102	\$ 1,470	\$ 1,855	\$ 3,158	\$ 1,470	\$ 1,855
6000	\$ 2,060	\$ 3,102	\$ 1,470	\$ 1,855	\$ 3,169	\$ 1,470	\$ 1,855

Note: Drives listed are for lifts with R18 winches only. Please inquire for pricing and information on electric drives for D&L winches. Credit \$175 for handwheel with the purchase of a direct drive and a new boat lift.



Direct A/C drive with manual switch



Extreme Max D/C drive with remote control and solar power box

- B Direct Drive** This direct drive uses an industrial oil bath gear reducer and motor with a stainless steel cover which connects to the standard winch. Available with a remote control option. Available as an AC or DC unit.
- C Extreme Max Drive System** Manual key or optional remote control operation with a backup bit for manual operation of the unit in the event of a power outage. Comes complete with mounting kit.
- D VL Solar Power Box** Portable solar power source for waterfront owners with no electricity. Lightweight white fiberglass box holds (2) deep cycle batteries with a power source on/off switch. Available as solar or with an A/C trickle charger. **Solar charged: \$ 1,539 A/C charged: \$ 1,479**



Above: "Forest Green" canopy.
Right: "Cadet Grey" canopy.



Traditional canopy shown above & right.
 Please visit our website for other style options available:
www.thedockdoctors.com/canopies

Traditional Sunbrella® Boat Lift Canopies

Lift Models	Description	Price	(unassembled)
35108/45108		21' × 108"	\$ 4,109
35108/45108		24' × 108"	\$ 4,442
45116		24' × 116"	\$ 4,528
45116		26' × 116"	\$ 4,646
45116		28' × 116"	\$ 5,094
40124/50124/60124/80124		24' × 124"	\$ 4,637
40124/50124/60124/80124		26' × 124"	\$ 4,846
40124/50124/60124/80124		28' × 124"	\$ 5,315
40124/50124/60124/80124		30' × 124"	\$ 5,493
100132		32' × 132"	\$ 6,335

SURCHARGE NOTICE: Due to supply issues and cost increases, a 10% surcharge will be applied to all of our printed prices until further notice and is subject to change.

Prices include aluminum canopy frame & fabric in standard colors:

● Pacific Blue ● Cadet Grey ● Forest Green ● Heather Beige ● Slate



Signature colors available as a special order at an additional cost.
 Additional costs for shipping may apply for canopies not in stock.

Pontoon & Tritoon Cradle Kits

Lift Model	Pontoon Cradle & Guide Kit	Tritoon Cradle & Guide Kit	Pontoon Deck Kit
4000-4500	\$ 1,120	\$ 1,412	\$ 733
5000	\$ 1,231	\$ 1,580	\$ 751
6000	\$ 1,354	\$ 1,726	\$ 751

Pontoon Cradle & Guide Kit



Pontoon Deck Kit



Boat Lifts : Hydraulic Lifts



- Available from 2,000 to 12,000 lb. capacity
- Stainless steel hardware
- Aluminum hydraulic cylinders with stainless steel fittings and hose assemblies
- Full length vinyl bunks
- Pontoon & Tritoon kits available
- Solar or AC charging options
- Manufactured by RGC®
- 15 year limited warranty



SURCHARGE NOTICE:
Due to supply issues and cost increases, a 10% surcharge will be applied to all of our printed prices until further notice and is subject to change.



Hydraulic Aluminum Lifts

Model #	Weight Capacity	Max. Beam	Lifting Height †	Min. Bunk Height	Shipping Weight	Lifting Speed UP (seconds)	Lifting Speed DOWN	Hydraulic Cylinders	(unassembled) Dock Doctors Price	(assembled) Dock Doctors Price
HL20065-48	2,000 lbs.	65"	48"	24"	235 lbs.	30 sec	20 sec	1	\$ 6,875	\$ 7,085
HL40120-60	4,000 lbs.	120"	60"	26"	542 lbs.	45 sec	45 sec	2	\$ 10,125	\$ 10,440
HL60120-48	6,000 lbs.	120"	48"	29.25"	710 lbs.	45 sec	45 sec	2	\$ 11,575	\$ 11,890
HL70120-60	7,000 lbs.	120"	60"	30"	760 lbs.	45 sec	45 sec	2	\$ 12,865	\$ 13,180
HL90120-60	9,000 lbs.	120"	60"	31"	997 lbs.	110 sec	75 sec	4	\$ 16,900	\$ 17,250
HL120132-60	12,000 lbs.	132"	60"	40"	1,500 lbs.	80 sec	90 sec	4	\$ 23,950	\$ 24,400

Prices above include (4) 3' legs, battery, AC charger & remote control. Solar charging also available for all lifts. All pricing is F.O.B. our facility in Ferrisburgh, Vermont. Prices are for in stock product only. Additional freight charges may apply for special orders. See page 3 for delivery information. † Measured from top of bunks to bottom of feet when adjustable legs are fully retracted. Measurements are approximate.

Pontoon and Tritoon kits available for Hydraulic Lifts - contact us for options and pricing.

Elevated Power Box Stand

This stand provides protection for your power box from heavy wave action or high water. Aluminum frame provides 15" of height above the deck surface. **\$ 295**

Power box not included in price.



HL Boat Lift Accessories: Guides, Extension Hoses and Extension Legs

Lift Model	Aluminum & Wood Guides	Stainless Ext. Hose 12' pair	Stainless Ext. Hose 20' pair	Ext. Legs 5' pair	Ext. Legs 7' pair w/ bracing	Ext. Legs 9' pair w/ bracing
4000	\$ 1,399	\$ 213	\$ 280	\$ 303	n/a	n/a
6000-7000	\$ 1,444	\$ 213	\$ 280	\$ 303	\$ 975	\$ 1,131
9000	\$ 1,489	\$ 213	\$ 280	\$ 303	\$ 975	\$ 1,131
12,000	\$ 3,562*	n/a	n/a	\$ 303	\$ 1,143	\$ 1,288

* Guides for 12K lift model are available in aluminum and vinyl only.

SURCHARGE NOTICE:
Due to supply issues and cost increases, a 10% surcharge will be applied to all of our printed prices until further notice and is subject to change.



Traditional canopy shown above. Please visit our website for other style options available: www.thedockdoctors.com/canopies

Traditional Style Hydraulic Lift Canopies

Size	Price
24' x 124" Canopy	\$ 4,347
26' x 124" Canopy	\$ 4,556
28' x 124" Canopy	\$ 5,025

Note: Prices include standard color Sunbrella® Fabric (● Pacific Blue, ● Cadet Grey, ● Forest Green, ● Heather Beige & ● Slate). Optional and signature colors are available as a special order (additional cost).



Canopy Leg Kits

Size	Price
4' Canopy Leg Kit with 8' posts	\$ 1,176
6' Canopy Leg Kit with 8' posts	\$ 1,355
8' Canopy Leg Kit with 8' posts	\$ 1,623

All pricing is F.O.B. our facility in Ferrisburgh, VT. Prices are for in stock product only. Additional freight charges may apply for special orders.

Boat Lifts : Ultimate Vertical Lifts

Ideal for boats from 6,000 to 32,000 lbs, our Ultimate Vertical Boat Lifts are manufactured with industrial quality hot-dipped galvanized steel. This lift is designed to be used in shallow, deep and fluctuating water applications. The 12,000 lb. and larger models are custom fabricated in modular sections for ease of seasonal handling.



Above: 32,000 lb. capacity Ultimate Lift.

Right: Modular section of the above boat lift being loaded for delivery.



Ultimate Vertical Boat Lifts

by The Dock Doctors

- Vertical lifts from 6,000 lb. to 32,000 lb. capacity
- 9 ft. standard lift height (other heights available)
- Great for shallow or deep water applications
- Adaptable to boathouses for use with permanent docks
- High lift for rough water & fluctuating water levels
- 12,000 lb. & larger models fabricated in modular sections to facilitate the initial installation
- Industrial quality hot dipped galvanized steel construction, stainless steel cables & galvanized fasteners
- Custom heights, widths & lengths are available to accommodate your boat & location



6,000 lb. capacity Ultimate Lift

Boat Lifts : Ultimate Vertical Lifts

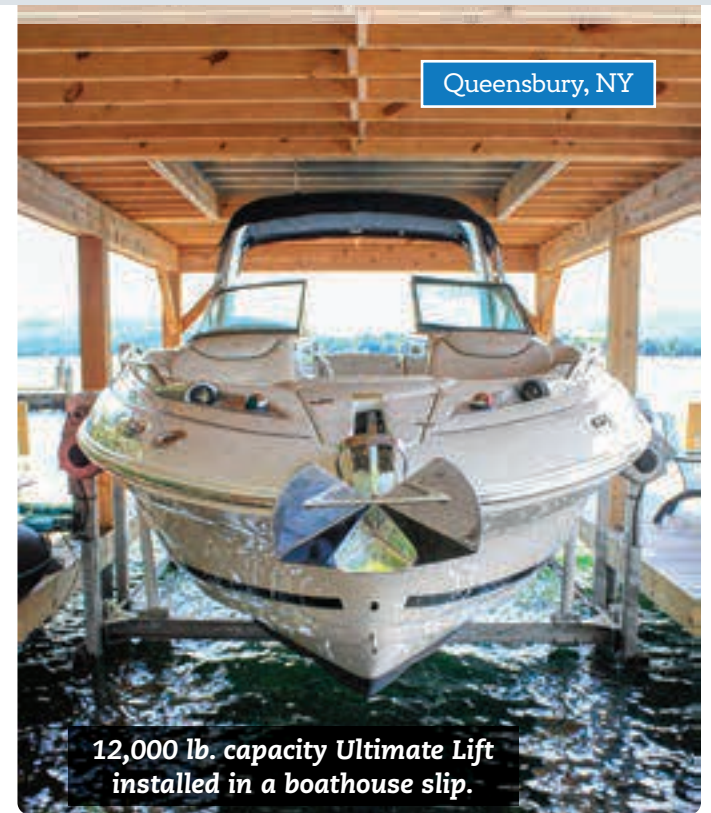

9,000 lb. capacity Ultimate Lift with custom canopy.

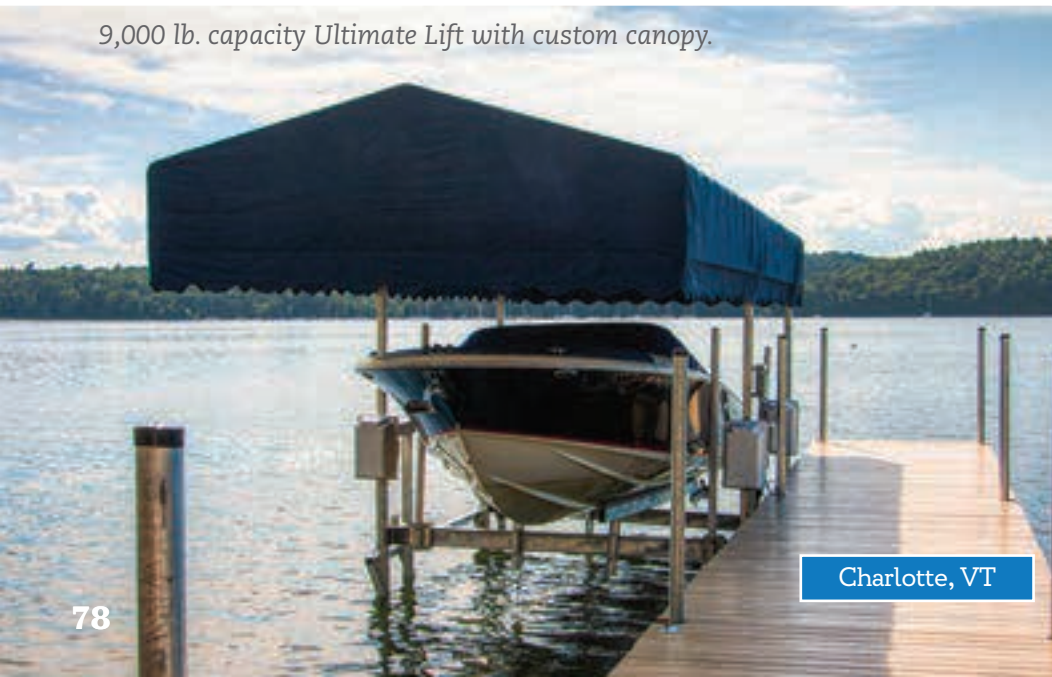

Charlotte, VT

9,000 lb. capacity Ultimate Lift with custom canopy.



Shelburne, VT

Dock Doctors® Ultimate Vertical Boat Lifts

Model #	Capacity	# of Drives	Maximum Beam	Lifting Height	Overall Width	Overall Length	Price*
STOCKED MODELS							
**NOTE - No surcharge on stocked models.							
6000	6,000 lbs.	2	9'	9'	11'	12'	\$ 14,835
9000	9,000 lbs.	2	10'	9'	12'	13'	\$ 16,675
CUSTOM MODELS							
12000	12,000 lbs.	4	10' 7"	8' 9"	13'	14'	call to inquire
18000	18,000 lbs.	4	11' 6"	8' 9"	14'	16'	call to inquire
24000	24,000 lbs.	4	13'	8' 11"	16'	18'	call to inquire
32000	32,000 lbs.	4	14'	8' 11"	17'	20'	call to inquire
Auto Stop System (recommended option)							call to inquire

Custom sizes are available.

*Prices above include Gem remote control, sealed bearing and grooved cable winders, AC drives, (4) 7' vertical guide poles with PVC sleeves, (4) wheel mounts, (4) 24" adjustable legs and heavy-duty bunks with vinyl hull guard. Optional oil bath drives and full length guide-ons are available. Please inquire for pricing.



Lake Winnepesaukee, NH

15,000 lb. capacity Ultimate Lift with standard 7' vertical guide poles with PVC sleeves.



Above: 24,000 lb. capacity Ultimate Lift with custom front end bow stop & optional oil bath drives.



Above: AC drives and Gem remote controls are standard features on our Ultimate Lifts.

Boat Lifts : Boathouse Lifts, Specialty Lifts, Custom Canopies

We custom fabricate Lifts for all types of sites & situations: For more details on our custom boat lifts see pages 28-29 in our custom catalog or visit our website at: www.thedockdoctors.com/custom-boat-lifts



Boathouse Lifts are custom built to be installed in new or existing boathouses.



Above: The Dock Doctors Ultimate Lift (pages 76-79) customized to attach to the shore with galvanized lift arms which allow it to be raised for winter storage.



Custom powder coated uprights for use with a standard RGC® canopy.



Seaplane lift utilizing a stock hydraulic lift with a custom turntable platform.

Installation Service ~ Let the Waterfront Specialists do it for you!

We provide service to all areas in the Northeast



Our portable workboats from 24'-40' in length allow us to provide installation for our products throughout the Northeast.



The Dock Doctors[®] LLC

Waterfront Specialists



1984 - 2022
38 YEARS'
experience



Take a virtual tour of our facility at:
www.thedockdoctors.com/tour

800-870-6756
www.thedockdoctors.com
info@thedockdoctors.com

Vermont Showroom & Manufacturing Facility
19 Little Otter Lane, Route 7, Ferrisburgh, VT 05456



Open
year-round!

Open Year-Round

Monday–Friday: 9am–4:30pm

Saturday: 9am–1pm (April 23rd thru July 23rd)

Closed Memorial Day Weekend and 4th of July

Lake Placid / Saranac Lake Product Display
876 State Route 86, Ray Brook, NY 12977



Product Display
Visit Anytime

Outdoor product display

NEW for 2022: No Staff - No Hours - Come by anytime
Located midway between Lake Placid & Saranac Lake

2022 STOCK CATALOG