

# The Dock Doctors<sup>®</sup> LLC

## Waterfront Specialists

2021  
STOCK  
CATALOG

Made in  
  
USA

### PRICE INCREASE NOTICE

Since our catalogs were printed in January 2021, material suppliers are implementing 8% - 12% price increases. These increases are in many sectors of the commodity market from steel, aluminum, plastic, vinyl, lumber, and composite materials. We unfortunately can no longer absorb these increases and will need to implement a 5% increase on all stocked products. Prices for "order online" products on our website include the 5% increase. Thank you for your understanding. Read more at: [thedockdoctors.com/covid-updates](https://thedockdoctors.com/covid-updates)

Readily  
Available for  
see page 3 for details



## Aluminum Stairs



## Boat Lifts



## Accessories



# The Dock Doctors<sup>®</sup> LLC

Waterfront Specialists



Manufacturing Facility



Warehouse & Distribution

**Factory Direct**  
*from our door to yours*

Local delivery & installation available throughout the Northeast



Nationwide Shipping



**800-870-6756**

[www.thedockdoctors.com](http://www.thedockdoctors.com)

[info@thedockdoctors.com](mailto:info@thedockdoctors.com)

Take a virtual tour of our facility at:  
[www.thedockdoctors.com/tour](http://www.thedockdoctors.com/tour)



Vermont Year-Round Showroom

**Free Estimates & Dock Layout (p. 2)**



**Free Curbside Delivery\* (p. 3)**



**Swim Floats & Pond Docks (pp. 4-7)**



**Dock Options & Accessories (pp. 8-18)**



**Aluminum Stairs (pp. 19-21)**



**Stock Docks readily available (pp. 22-45)**



**Launch & Rowing Docks (pp. 46-51)**



**Boat Lifts & Canopies (pp. 52-64)**



**Installation & Removal Services (p. 65)**





# Free Dock Design Service

Our experienced staff will create a **FREE dock layout and estimate** designed to your specific site and individual needs.



[www.thedockdoctors.com/site-survey](http://www.thedockdoctors.com/site-survey)  
or call us at: **800-870-6756**

Download our other catalogs at: [www.thedockdoctors.com/catalogs](http://www.thedockdoctors.com/catalogs)

or call us at 1-800-870-6756 to have one mailed to you today.



## CUSTOM CATALOG

- Custom Docks
- Marine Construction
- Custom Stairs & Waterfront Access
- Hillside Trolleys
- Commercial & Municipal Dock Systems
- Marine & Specialty Contractors
- Boat Houses



## PADDLE PRODUCTS

- Storage Racks for kayaks/canoes
- Aluminum Paddlesport Trailers
- Kayak Lift & Launch
- Small Craft Dock & Launch Systems
- Paddle & Rowing Docks

# Free Curbside Delivery





**Look for the truck for our stock products that qualify for free delivery\*!**



Minimum Purchase Amount (not including sales tax)	Free Delivery from Ferrisburgh, VT (distance based on Google Maps)	Delivery Charge one-way (over the free mile range)
\$ 1,000	25 miles	\$2. <sup>50</sup> / mile
\$ 2,000	50 miles	\$2. <sup>50</sup> / mile
\$ 4,000	100 miles	\$2. <sup>50</sup> / mile
\$ 6,000	150 miles	\$2. <sup>50</sup> / mile
\$ 8,000	200 miles	\$2. <sup>50</sup> / mile**
\$ 10,000	250 miles	\$2. <sup>50</sup> / mile**

## \* Free Curbside Delivery Terms & Conditions:

1. Curbside delivery definition: We will back up as close as we can with our vehicle to your installation site and off-load your product. We cannot carry your product further than the side/rear of our truck/trailer. Our delivery vehicles cannot go off of approved driveway surfaces (ie on grass, etc.).
2. Free delivery available on The Dock Doctors® Stock Products only. Please see chart above for minimum purchase amounts to qualify for free delivery. Free delivery does not apply to Rowing or Paddle Docks or Ultimate Boat Lifts.
3. Connect-A-Dock, Boat Lifts, canopies & accessories – free delivery applies to products in stock only.
4. If you want your product installed, please inquire on rates for this service – free delivery does not apply.
5. Additional fees apply for wide loads (assembled boat lifts) & ferry charges, if needed.
6. Purchases under \$1000 are subject to a \$2.50 per mile one way charge from Ferrisburgh, VT. A ground shipping method/charge by another source such as Common Carrier or UPS may be more feasible depending on product purchased.
7. \*\*Due to regulations for hourly driving restrictions by the Federal Motor Carrier there may be an additional fee applicable to deliveries 200 miles or over for overnight charges.

# Swim Floats : Aluminum & Galvanized Steel Frames



see page 3 for details



Aluminum swim float with Weardeck® decking in Barefoot Sand.

## Aluminum Swim Float

Medium-duty, ideal for calm bays or small bodies of water

- Lightweight one-piece aluminum frame
- Includes 3' aluminum ladder
- Removable decking panels
- Stocked in 8' × 8' size



8' × 8' Swim Float with removable deck panels

### Aluminum Swim Float (shown above)

Ideal for use in small lakes or calm bays. One piece lightweight aluminum frame with polyethylene floats. Includes 3' aluminum ladder and removable decking panels.



Stock Size	Weight*	CEDAR		WEARDECK®	
		Net Buoyancy	Price	Net Buoyancy	Price
8' × 8'	162 lbs.	865 lbs.	\$ 1,919	787 lbs.	\$ 2,229

\*Weight is with decking removed. Custom size swim floats available, please contact us for details.  
Ipe hardwood or other composite decking options available. See decking details and color choices on p. 8.

### Light Duty Float Harness

Includes shackles, swivel, 3' of 3/8" chain & (2) 10' nylon ropes. **\$99**

### Nylon Rope Extension

Amount needed is 1.5 × the water depth  
14' (\$47), 18' (\$49), 22' (\$51)

### Concrete Anchor (Light Duty)

18" × 8", 180 lbs. **\$115**



For more info on anchoring, visit:  
[www.thedockdoctors.com/swim-float-anchoring](http://www.thedockdoctors.com/swim-float-anchoring)



Galvanized steel swim float with cedar decking.



see page 3 for details

## Galvanized Steel Swim Float

Heavy-duty, ideal for rough water

- Two-piece galvanized steel frame
- Includes 3' aluminum ladder
- Removable decking panels



Heavy duty galvanized steel swim float dismantles into two pieces for ease of handling.

### Heavy Duty Galvanized Steel Swim Float (shown above)

Ideal for rough water. Dismantles into two pieces for ease of handling. Includes 3' aluminum ladder and removable decking panels.



Stock Size	Weight*	CEDAR		WEARDECK®	
		Net Buoyancy	Price	Net Buoyancy	Price
8' × 8'	238 lbs.	789 lbs.	\$ 2,009	711 lbs.	\$ 2,309
8' × 10'	248 lbs.	778 lbs.	\$ 2,219	638 lbs.	\$ 2,598
10' × 10'	476 lbs.	1,787 lbs.	\$ 2,925	1611 lbs.	\$ 3,398

\*Weight is with decking removed. Custom size swim floats available, please contact us for details.

Ipe hardwood or other composite decking options available. See decking details and color choices on p.8.

### Heavy Duty Float Harness

Includes shackles, swivel & (2) 10' nylon ropes. Chain sold separately. **\$159**

### Galvanized Chain

Amount of chain needed is 1.5 × the water depth. **\$4.<sup>50</sup>/foot**

### Concrete Anchor (Heavy Duty)

2" × 2" × 8", 400 lbs. **\$139**



For more info on anchoring, visit:

[www.thedockdoctors.com/swim-float-anchoring](http://www.thedockdoctors.com/swim-float-anchoring)

# Pond Docks : Aluminum & Galvanized Steel Frames

Designed for ponds or bodies of water with little to no wave activity or water level fluctuation.



**B** 4' x 20' Pond Dock  
galvanized steel frame  
shown with composite decking  
(special order color)

## Pond Docks

Available in a galvanized steel frame or new 4-piece aluminum frame.

- Removable decking panels
- Galvanized steel frame pond docks available in 4' x 16' and 4' x 20' sizes
- 4-piece aluminum frame pond dock available in 4' x 18' size, designed for common carrier shipping
- Optional aluminum ladder (see p. 18)



**C** 4' x 18' Pond Dock  
4-piece aluminum frame  
(shippable)

**Ships on a  
4' x 10' pallet**

Calculate shipping to your location at:  
[www.thedockdoctors.com/aluminum-pond-dock](http://www.thedockdoctors.com/aluminum-pond-dock)





**A** 4' x 16' Pond Dock galvanized steel frame shown with optional ladder and composite decking



**C** 4' x 18' Pond Dock 4-piece aluminum frame

## Pond Docks

see page 3 for details



Galvanized steel frame, or new 4-piece aluminum frame. All pond docks feature removable decking panels and black polyethylene floats. Includes (2) 3 ft. long 1 1/2" pipes with safety caps.

Stock Size	Weight*	CEDAR		WEARDECK®	
		Price		Price	
<b>Galvanized Steel Frame</b>					
<b>A</b> 4' x 16'	289 lbs.	\$ 2,398		\$ 2,989	
<b>B</b> 4' x 20'	410 lbs.	\$ 3,215		\$ 3,969	
<b>Aluminum Frame (4-piece)</b>					
<b>C</b> 4' x 18'	322 lbs.	\$ 3,229		\$ 3,939	

\*Weight is with decking removed. Custom size swim floats available, please contact us for details. Ipe hardwood or other composite decking options available. See decking details and color choices on p.8.

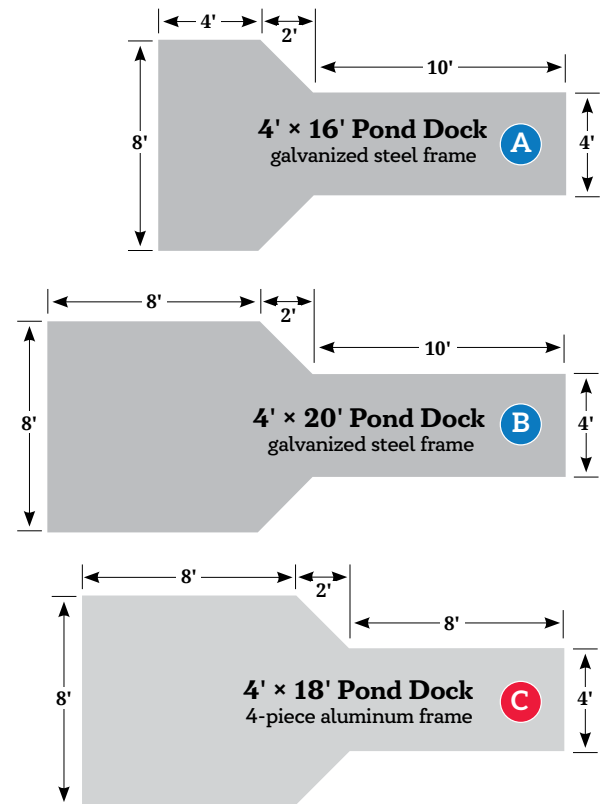

# Options & Accessories : Decking Choices

Choosing the decking for your new dock system is an important choice, and there are many factors to consider. Maintenance, cost, color and personal style-preferences.



**CEDAR** is a natural, cost effective decking option that is naturally resistant to decay and insects. We use STK Western Red Cedar (Select Tight Knot Grade or Number 2 ). It is generally

regarded as a high-quality choice for cedar, and any knots present are sound encased and tight. The wood is generally straight-grained and has a uniform, but rather coarse texture.

*CONS: Over time, cedar will absorb moisture and weather to a soft silvery gray unless sealed with a preserving stain.*

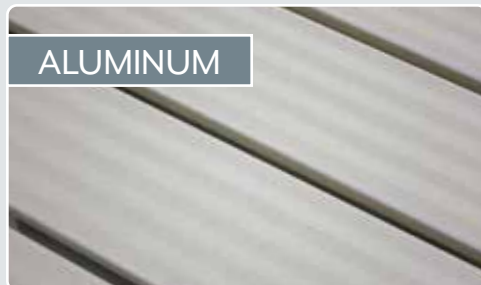

**ALUMINUM** resists the growth of mold and mildew and won't rust, rot, split or stain. This painted then baked beige finish eliminates glare from the aluminum.

The non-slip, rigid, surface is

low-maintenance and cool to the touch. Color is Sherman Williams Beige PHT160052.

*CONS: Can sound metallic when walking on it, especially on our docks with removable panels.*



**WEARDECK** is a high density polyethylene resin with UV inhibitors. WearDeck's 5/4" thick deck board is rated to span joists 24" on center with the highest live load capacity in the industry. Rated for ground and underwater contact and will not support mold or mildew growth. This product is 100%

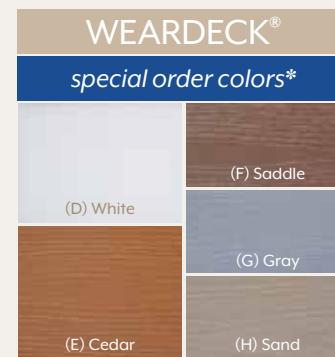
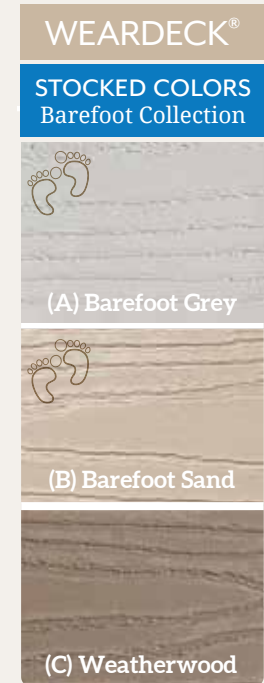

\*please inquire for pricing and lead times.



manufactured in Ocala, FL and offers a 25 year commercial and a lifetime residential warranty.

*Cons: Not a natural wood.*

## Barefoot Collection

*"Lighter Colors, Cooler Touch"*

### Heat-Reflective Technology

- Reflects the sun's hot rays off the surface of the board
- Reduces surface temperature by at least 30% on each color

## Ipe Hardwood Decking Upgrade



**IPE** is extremely hard, very durable and naturally resistant to rot and insects. Ipe's strong, resilient properties make it an excellent material choice for marine applications.

*Cons: Due to the density of Ipe, it is heavy and hard to drill and cut, therefore more labor intensive than working with other decking materials. It is also a natural wood, therefore there will be inconsistencies with regard to color, weathering and texture.*



**SURE-STEP** is a slip-resistant, polypropylene surface that allows water and sunlight through to help conserve the underwater ecosystem. Preferred option for dock structures that are situated close to the water so waves will

pass through the decking, adding minimal resistance. Color: Grey.

*Cons: Only available in certain dimensions, so may not be a viable option for many applications.*

This product **ONLY** available on our Standard Duty Aluminum Leg & Wheel Docks

## Decorative Option



*Wooden skirtboards are used to camouflage the steel truss frame, providing the appearance of a wooden dock system. Please inquire for pricing and details.*



**All our products  
are proudly made  
in the USA**

# Options & Accessories : Vertical Fenders, Cleats



Shipping Available

## Protect your boat and dock with our adjustable vertical fenders

(available for all dock systems)

Our unique vertical fender design provides a double adjustment both on the fender mount & on the dock support pipe (see diagram page 11) – which is often necessary due to lake level and boat style. Add a fender cleat kit (see **G** on p. 11) for a complete securing system for your boat.

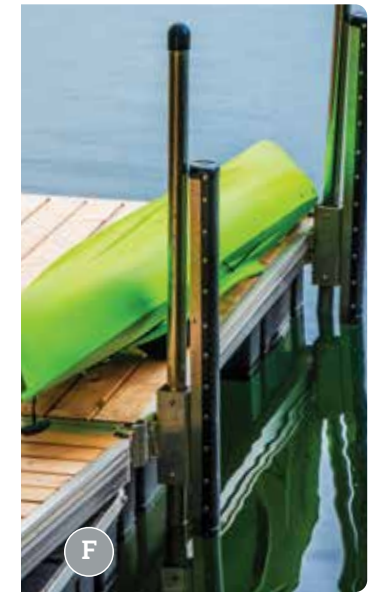

### Vertical Fenders

Fender Style	Mounting Style	3' long	4' long
<i>For all Aluminum Leg &amp; Wheel Docks &amp; Steel Truss Leg Docks with 1 1/2" pipe:</i>			
<b>A</b> Fender	1 1/2" pipe mount	<b>\$ 149</b>	<b>\$ 169</b>
<b>B</b> Double Corner Fender	1 1/2" pipe mount	<b>\$ 265</b>	<b>\$ 315</b>
<i>For all Steel Truss Wheel Docks with 1 1/2" pipe:</i>			
<b>C</b> Fender with offset	1 1/2" pipe mount	<b>\$ 159</b>	<b>\$ 179</b>
<i>For all Mega Leg Docks with 3" pipe or Custom Articulating Docks with 2" pipe:</i>			
<b>D</b> Fender	2" or 3" pipe mount	<b>\$ 185</b>	<b>\$ 205</b>
<i>For all Aluminum "Track-Frame" Floating Docks:</i>			
<b>E</b> Fender	Track Mounted	<b>\$ 162</b>	<b>\$ 182</b>
<i>For all Aluminum "Track-Frame" Floating Docks - includes spud mount:</i>			
<b>F</b> Fender	Spud Anchor Mounted	<b>\$ 350</b>	<b>\$ 370</b>

# Vertical Fenders, Cleats

## Our Vertical Fenders offer two forms of adjustment:

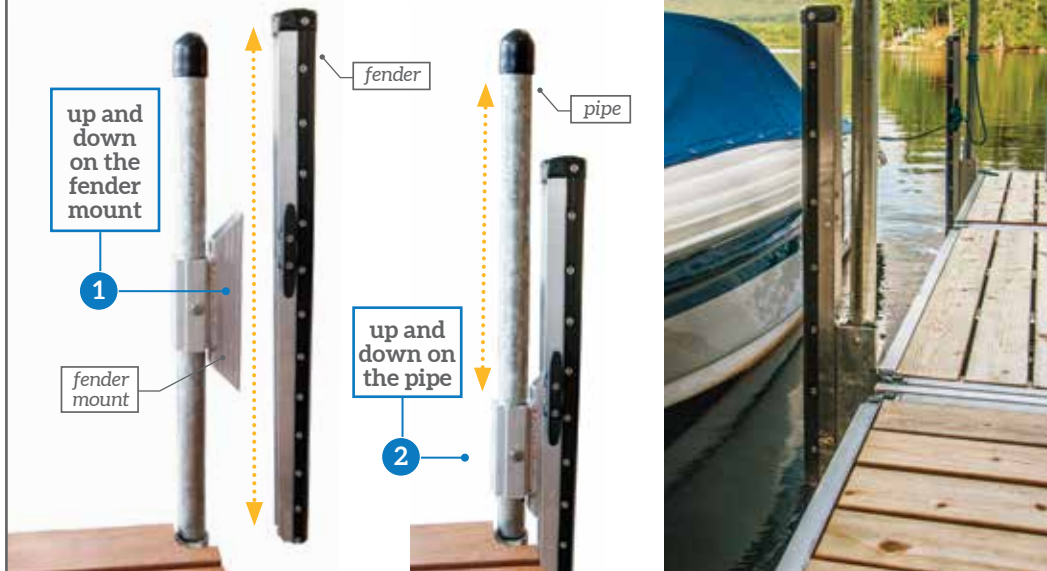

The unique design of The Dock Doctors vertical fenders provide exceptional performance by separating the impact and movement of the boat from the dock.

- Our quality fender material provides adequate cushion for protection – but is firm and slick enough to allow the boat gunnel to slide up and down without friction that could cause damage to seasonal docks.
- The vertical orientation and fender length allows the boat gunnel to keep contact with the fender, especially with water fluctuation or wave action.

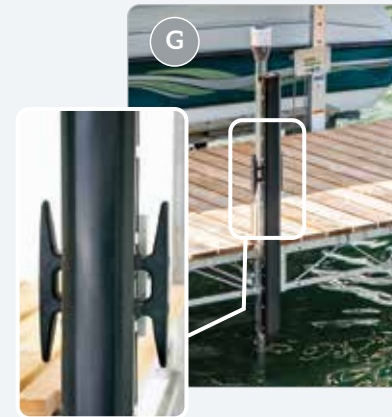

### Fender Cleat Kit

Designed to be used with the 3' or 4' fenders shown on page 10. Includes (2) cleats per kit that bolt onto the fender mount.

**\$ 40 per kit**

includes 2 cleats and hardware to attach to vertical fender



### H Pipe Cleat (for 1 ½" pipe)

A single cleat mounted to a sleeve that slides over the leg pipe. Available for all leg & wheel docks except the mega leg & wheel docks.

**\$ 35 each**

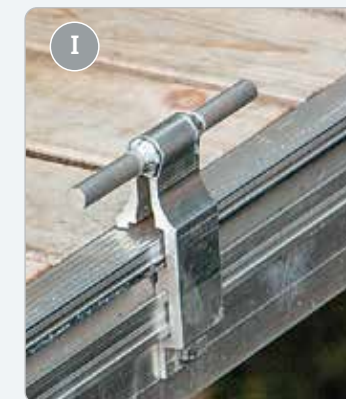

### I Track Cleat

Designed to slide along the track of our floating aluminum track dock systems.

**\$ 23 each**

# Options & Accessories : Edge Fenders, Mooring Whips, Boat Access

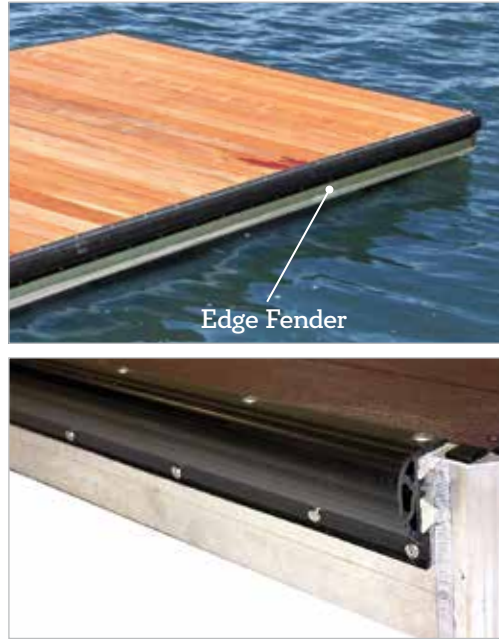
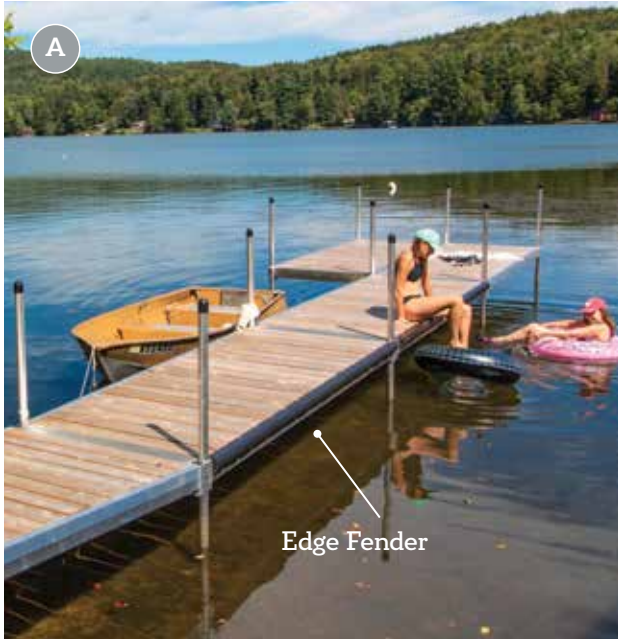

## A Edge Fender

An alternative to our vertical fenders, this high quality, non-marring black edge fender can be installed on our Aluminum Leg & Wheel Docks (standard and medium duty), our Aluminum Floating Docks and our Custom Steel Truss Floating Docks.

**\$ 7.<sup>75</sup> per foot**

*(material only, not installed, not including fasteners)*

**\$ 10.<sup>95</sup> per foot**

*(installed with stainless steel fasteners\*)*

*\*installation available on new dock orders only*



## B Taylor Made Mooring Whips

Mooring whips with fixed angle base. Two-piece kit, will need to be epoxied (epoxy included with kit). Recommended for low profile boats such as bass boats, runabouts and sport boats.

MW120: **\$ 585** for 18' – 23' boats / 2,500–5,000 lbs.

MW140: **\$ 685** for 24' – 28' boats / 5,000–10,000 lbs.

**Disclaimer:** Some docking conditions may be too rugged for this product.

## C Mooring Whip Dock Mounts (for Dock Doctors docks)

Required for docks with removable decking. **\$ 149**

(for Taylor Made mooring whip models listed above only)



Truss frame mount



Track frame mount



D

## D Sliding Boarding Step

Our sliding boarding step easily slides and retracts so you can safely board your boat from your dock. Securely attaches to your existing dock. Includes a safety handrail that can mount to either side of platform.

**\$ 915**

*Great for people and pets!*



E

## E Boarding Handle

Providing a safe handhold when boarding your boat, our boarding handle is made with marine-grade aluminum. Mounts for **Dock Doctors** floating aluminum track dock systems or universal mount to attach to any dock frame. Height from mount to top of handle is 48".

**Boarding Handle \$ 105**

Mounts (*not included with handle*):

Track Mount (shown)..... **\$69**

Universal Mount ..... **\$69**

## F Lower Access Platform for swimming & kayaking

Stationary leg docks are often quite a distance above the water's surface, making accessing the water for swimming or kayaking very difficult. Our lower access platform is designed to provide you with a safe transition to the water.



Dock Ladder (optional)

15" wide

9' 3" long



F

- 5" tall aluminum frame
- Sure-Step® flow-thru, anti-slip decking
- Designed to be used alongside any 8'-10' long dock with 1 ½" support pipes
- Adjustable sleeves slide over 1 ½" support pipes

Lower Access Platform: **\$769**  
add optional ladder (*see p. 18*)

## Storage Racks: Kayak/Canoe/PaddleBoard

Marine-grade aluminum frame small craft storage racks. Available in freestanding, wall mounted, and dock mounted styles. Featuring arms with vinyl hull guards and end caps with built-in tie-down openings. Crafts can be secured with a cable and lock (not included).



adjustable arms with eye-bolts for securing tie-downs



end caps with built-in tie-down openings



optional bungees to secure your craft (adjustable 10"– 48")



Commercial Storage Rack

See more styles in our Paddle Products catalog or on our website [www.thedockdoctors.com/shop](http://www.thedockdoctors.com/shop)



See more styles on our website or in our [Paddle Products](#) catalog.



## Kayak/Canoe Storage Racks

See our [Paddle Products](#) catalog or visit our website for our full line of storage racks.

Rack Style	Craft Storage	Price	while supplies last	
			STANDARD ALUMINUM	POWDER COATED BLACK
A Double-Sided	6-Craft	\$ 929	<del>\$1,219</del>	<b>\$1,109</b>
B Single-Sided	3-Craft	\$ 699	<del>\$ 929</del>	<b>\$ 789</b>
C Mini	3-Craft	\$ 489	<del>\$ 615</del>	<b>\$ 579</b>
D Wall-Mounted	3-Craft	\$ 519	<del>\$ 709</del>	<b>\$ 609</b>
E Tie-Down Bungees (pair)	n/a	\$ 21. <sup>98</sup>	n/a	
F Adjustable Feet (pair)	n/a	\$ 165	<b>\$ 190</b>	
G Additional Arms (pair)	n/a	\$ 115	<b>\$ 140</b>	

**Powder Coated Black**

**Storage Rack Inventory Reduction Sale!**

\*While supplies last!



# Aluminum Storage Racks & Kayak Launching

## Dock Mounted Storage (Kayak, Canoe, Paddleboard)

Marine-grade aluminum small craft storage. Arms feature vinyl hull guards and end caps with built-in tie-down openings. Crafts can be secured with a cable and lock (not included).



### A Storage Arms (pair) (single craft, dock mounted)

A pair of storage arms which slide onto the leg pipes of your dock.

Note: Fits all docks with 1 1/2" pipe\*.

STANDARD ALUMINUM **\$ 175**

POWDER COATED BLACK **\$ 192** regular \$199

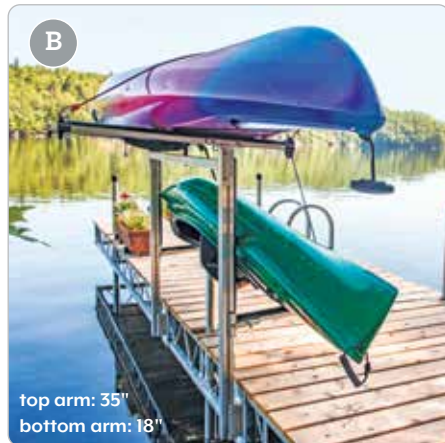

### B Storage Rack (2-craft, dock mounted)

Our two-craft storage rack mounts to the frame of your dock and stores two crafts and paddles/oars. Top arm is 35", bottom arm is 18" (wider crafts can be stored at an angle).

STANDARD ALUMINUM **\$ 520**

POWDER COATED BLACK **\$ 615** regular \$679

Mounts Available  
(please indicate when ordering):

- Dock Doctors Steel Truss Frame mount
- Dock Doctors Aluminum Track mount
- Universal Mount (for wood dock systems)



See our full line of storage racks, trailers and launch products in our Paddle Products catalog or online at:  
[thedockdoctors.com/paddle-products](http://thedockdoctors.com/paddle-products)

Launching Kayak/Canoes from your dock or seawall can be a challenge due to water levels, wind and waves, and overall flexibility. We have a variety of products to help launch your small craft so you can enjoy your time on the water.

## Dock Mounted Roller

A single 12" keel roller designed to assist you when moving canoes, kayaks, or other small crafts on or off your dock. **\$ 116**

Universal surface mount or Dock Doctors Aluminum Track Frame Mount.



Dock Doctors aluminum track frame mount

Universal Surface Mount



Watch a video and find out more at:  
[thedockdoctors.com/kayak-roller](http://thedockdoctors.com/kayak-roller)

## Kayak Lift

Our innovative kayak lifts feature a platform that raises and lowers so you can safely and easily launch your kayak from a seawall or permanent dock. Model KL100-30 (shown left) has a lifting height of 30" and can accommodate crafts up to a 38" beam width. Also available with a ladder for a higher lifting height. See full details and other model options in our Paddle Products Catalog or on our website.

Model KL100-30 **\$1,825**



Photo courtesy of M. Warkentin

Watch a video and find out more at:  
[www.thedockdoctors.com/kayak-lift](http://www.thedockdoctors.com/kayak-lift)

Ships FREE  
within the continental USA



# Options & Accessories : Sea Gull Eliminators & Solar Lights

## **BIRD•B•GONE**<sup>Inc.</sup> Sea Gull Eliminators



### Bird Spider 360°

The spider's spinning motion is effective at deterring birds from landing on your boat, swim raft or dock. Stainless steel arms with scuff-preventing polycarbonate tips move with the breeze. Permanent glue-on base or use optional sandbag mount.

4' Diameter Spider \$ 49.<sup>99</sup>    8' Diameter Spider \$ 59.<sup>99</sup>



### 360° Repellent

6' diameter, wind driven rotator keeps birds from roosting on your boat, swim raft or dock. Includes standard mounting block (screws included). Portable sandbag mounts sold separately.

360 Repellent \$ 49.<sup>99</sup>



### Sandbag Base

Attaches directly to either style repeller (hardware included). Eyelets around outer ring for extra security. Weighs 8 lbs.

Sandbag Base \$ 41.<sup>99</sup>



Easy Hassle Free Mounting  
No Wiring Required



\$ 55.<sup>95</sup>  
package of 2

### Solar Dock Post Lites

- Fits standard pipes (1 1/2" & 2" ID in size)
- 6" H x 3.5" diameter (UV stabilized polycarbonate)
- (1) Super bright LED (12 Lumens)
- Automatic night activation
- Fully sealed electronic circuit board
- Powerful solar panel
- Lasts 18+ hours on a full charge
- Replaceable 1.2v NiMH battery
- Two (2) post lites in each package



### 1 3/8" Dock Dots

The smallest solar lights you have ever seen!  
Easy to install in minutes with a quick 1 3/8" drill bit or hole saw.

\$ 55.<sup>95</sup>  
package of 4

Available with  
white LEDs only



### Deck Lights

Industrial strength solar powered dock light. Marine grade anodized aluminum offers superior protection in harsh marine environments.

\$ 36.<sup>95</sup>  
each

Available with  
white LEDs only



## Adjustment Kit

Adjust the level of your dock with this kit that slides over the 1 1/2" leg pipe. Available for all leg & wheel docks with 1 1/2" pipe. Sold as a pair (winch with sleeve and hook).

**\$ 269** / pair

See page 39 for our Mega Dock adjustment kit.

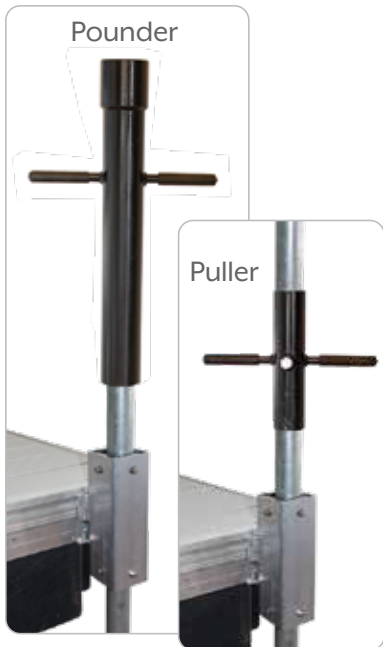

## Spud Puller & Pounder Kit

This (2) piece system aids in the installation and removal of spud pole anchors for our floating dock systems.

**2" puller/pounder kit: \$ 275**

**3" puller/pounder kit: \$ 345**

## 16' Aluminum Telescoping Flag Poles

Add beauty to your waterfront property with a telescoping flagpole. Each section of the pole raises and lowers easily, and with no ropes, chains or pulleys they are virtually noise-free.



16' tall telescoping aluminum flagpole includes a 3" gold aluminum ball ornament, a double flag harness to fly two flags or fly at half mast, a 3' x 5' nylon USA flag with embroidered stars and sewn stripes. Other pole heights available as special order.



## Flag Poles

Style	Suggested Retail	Our Price
A1 Silver Finish 16' Flag Pole	\$ 339	<b>\$ 299</b>
A2 Black Finish 16' Flag Pole	\$ 369	<b>\$ 319</b>
Dock Mounts (for flagpoles)		Our Price
B Deck surface mount		<b>\$ 85</b>
C Side mount		<b>\$ 85</b>
D Pole mount for docks with 1 1/2" leg pipe		<b>\$ 85</b>

# Options & Accessories : Ladders & Steps



## Dock Ladders

(available for all dock systems)

One-piece, removable vertical ladder with 1 ½" tubular aluminum frame and arched, slip resistant 4" treads for added comfort with bare feet.

Stock Size	PRICE
3' ladder	\$ 243
4' ladder	\$ 263
5' ladder	\$ 283

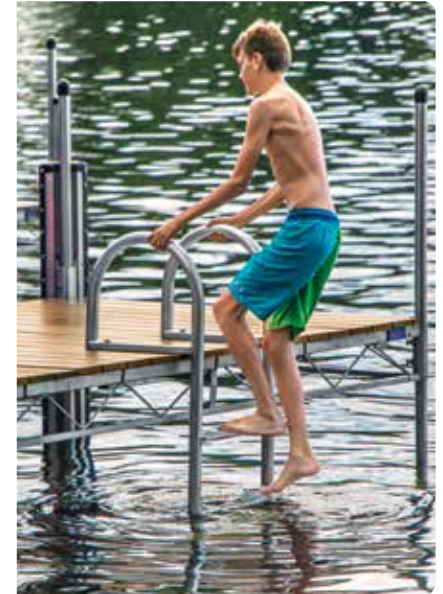

Please note compatibility with your style of dock when ordering accessories and options.



## Shallow Water Stairs

(available for all leg & wheel docks)

One-piece welded aluminum structure with aluminum handrails down each side and non-slip treads with adjustable footpads.

Stair Size	Elevation <sup>1</sup>	PRICE
4 step	37" – 49"	\$ 637
5 step	45" – 57"	\$ 687
6 step	53" – 65"	\$ 737

<sup>1</sup>Accommodates elevation from deck surface to lakebed.



# Waterfront Access : Aluminum Stairs

Our lightweight aluminum stair kits are designed to accommodate a variety of applications. Offering a lifetime of virtually maintenance free features, these quality aluminum stairs are an economical solution for waterfront or hillside access and ideal for replacing your old wooden steps.

*Not recommended for in-water use.*



Optional adjustable footpad for uneven surfaces.

## Aluminum Stair Features

- Readily available in lengths up to 18'
- Non-skid, 28" wide stair treads
- Rounded aluminum handrails on both sides
- Adjustable rise & run (27 to 44 degrees) to accommodate your site
- Marine grade aluminum extrusions with stainless steel fasteners (not recommended for in water use)
- Lightweight & easy to carry for a two-person installation
- Custom fabrication available for specific applications & lengths
- Optional adjustable footpads for base of stairs
- Includes mounting bracket (designed for easy seasonal installation & removal of stairs)



3' x 4' stair platforms incorporated into a long run of stairs.

# Waterfront Access : Aluminum Stairs



4-step



6-step



Our 4 and 6-step stairs ship UPS ground



10-step

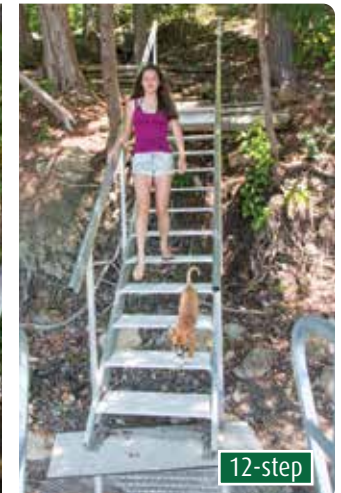

12-step



Our 8 thru 16-step stairs ship UPS freight

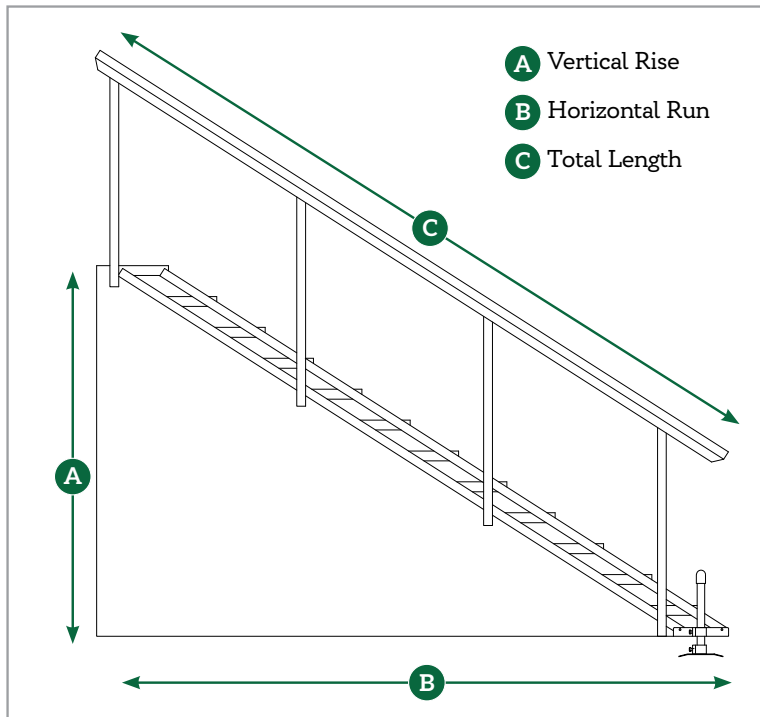

## How to measure for stairs

A few simple measurements can help determine the recommended length of stairs for your particular site.

For tips on how to measure, visit our website at:

[www.thedockdoctors.com/stair-kits](http://www.thedockdoctors.com/stair-kits)

# Aluminum Stairs

All stair treads are 28" wide

All stairs can be assembled to fit any distance between the minimum and maximum rise.

# of Steps	Price*	MINIMUM RISE			MAXIMUM RISE			Weight
		Rise @ 6" (27°)	Run with 6" rise	Length with 6" rise	Rise @ 9" (44°)	Run with 9" rise	Length with 9" rise	
4	\$ 755	2' 0"	4' 7"	5' 0"	3' 0"	3' 11"	4' 11"	70 lbs.
6	\$ 1,055	3' 0"	6' 6"	7' 2"	4' 6"	5' 6"	7' 1"	100 lbs.
8	\$ 1,255	4' 0"	8' 5"	9' 4"	6' 0"	7' 1"	9' 3"	122 lbs.
10	\$ 1,499	5' 0"	10' 4"	11' 6"	7' 6"	8' 8"	11' 5"	150 lbs.
12	\$ 1,769	6' 0"	12' 3"	13' 8"	9' 0"	10' 2"	13' 7"	174 lbs.
14	\$ 1,999	7' 0"	14' 2"	15' 10"	10' 6"	11' 9"	15' 9"	202 lbs.
16	\$ 2,279	8' 0"	16' 1"	18' 0"	12' 0"	13' 3"	17' 11"	225 lbs.
n/a	\$ 609	3' x 4' stair platform (standard duty aluminum with aluminum decking)						45 lbs.

\*Price includes mounting bracket (fasteners to existing platform not included); handrails down each side and slip resistant stair treads. Stair uprights remain vertical in any rise. Optional top and/or bottom stair platform in 3' x 4' standard duty aluminum. Optional pair of Adjustable Footpads includes brackets to mount to bottom of stairs, 1 1/2" aluminum support pipes 24" long, black safety caps & aluminum footpads. Requires stair frame drilling on-site to mount.



mounting bracket



rounded aluminum handrail



non-skid, 28" wide aluminum stair treads



(optional)

**Adjustable Footpad**

**\$200 / pair**

Requires drilling stair on-site to mount.



3' x 4' platform



Calculate shipping costs on our website at:  
[www.thedockdoctors.com/stair-kits](http://www.thedockdoctors.com/stair-kits)



Assembly Options: Unassembled: Requiring assembly on site to contour to desired rise (note: some drilling is required).

Pre-assembled: Factory assembled and adjusted to desired rise (note: additional assembly charge will apply).

\*Prices do not include shipping/delivery. To calculate shipping to your location, please visit: [www.thedockdoctors.com/stair-kits](http://www.thedockdoctors.com/stair-kits)

## Leg & Wheel Docks : Standard Duty Aluminum



see page 3 for details



Designed for smaller lakes and bays, our standard duty aluminum frame leg and wheel docks feature an exceptionally strong aluminum frame. Strong yet lightweight, these docks can be installed by one person.

Groton, VT



## Standard Duty Aluminum Leg & Wheel Docks

- Exceptionally strong aluminum frame
- Support stanchions built into the frame for an obstruction-free dock edge
- Removable decking in cedar, composite – or attached Sure-Step® decking
- Ipe hardwood decking option also available



Salisbury, VT

*Standard duty aluminum leg dock with composite decking (special order color), shallow water stairs (see page 18) and 4,500 lb. Vertical Boat Lift.*

### EASY one person install



Our innovative connector clips and lightweight sections allow for one person to easily connect sections together and install the dock system.



Hinesburg, VT

# Leg & Wheel Docks : Standard Duty Aluminum

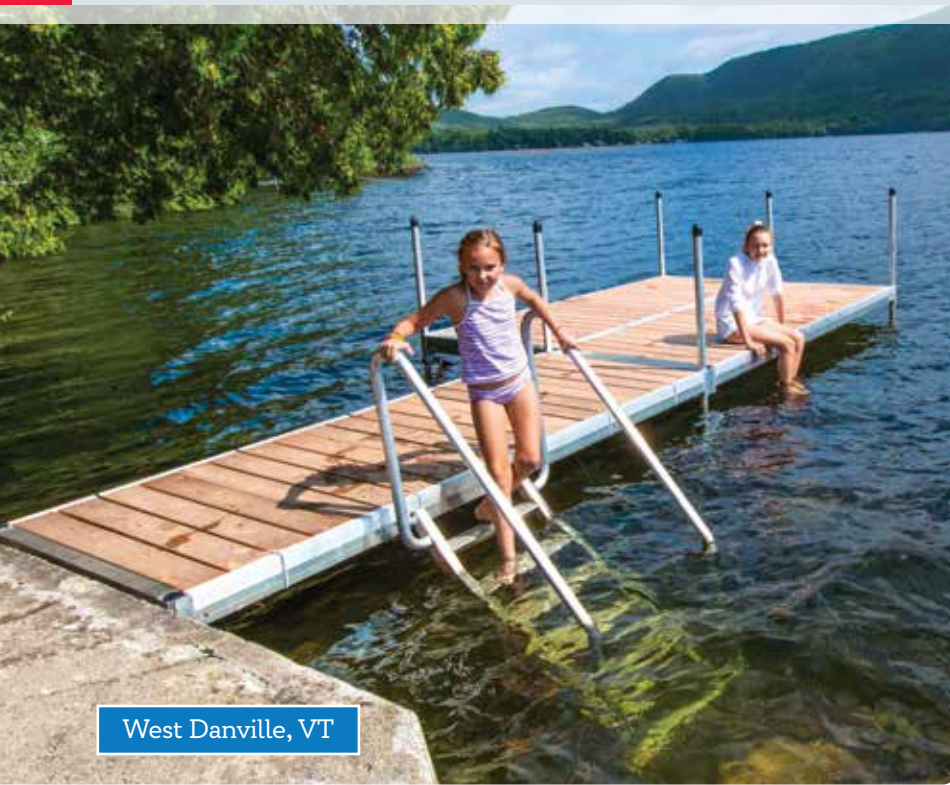

West Danville, VT

Standard duty aluminum leg dock with cedar decking and our shallow water stairs (see page 18).



Lake Placid, NY

**Above & Right:** Standard duty aluminum leg dock with cedar decking and our freestanding launch port system.

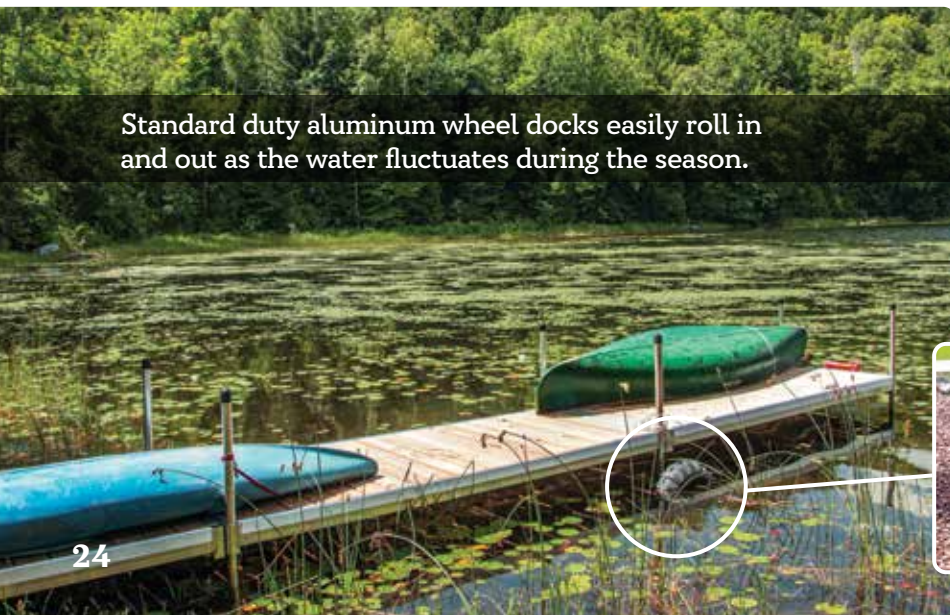

Standard duty aluminum wheel docks easily roll in and out as the water fluctuates during the season.



Watch a video and find out more at:  
[thedockdoctors.com/launch-port](https://thedockdoctors.com/launch-port)

## Assembly Components

**Connector Clips**  
for connecting  
docks together  
**\$ 27** set of 2



**Safety Cap**  
for 1 1/2" pipe  
**\$ 5.50** each



**Aluminum  
Pipe 1 1/2"**  
cut to length  
pending  
water depth  
**\$ 6.95** per foot



**Footpad**  
(aluminum)  
**\$ 37** each



**Cross Braces**  
(optional)  
stabilizes docks  
in deeper water  
4 foot: **\$ 155**  
6 foot: **\$ 165**  
8 foot: **\$ 175**  
10 foot: **\$ 185**



Size based on distance between support pipe.



4' x 8' Leg Dock  
with removable deck panels



4' x 12' Wheel Dock  
with removable deck panels

see page 3 for details



## Standard Duty Aluminum Leg & Wheel Docks

See decking & color choices on page 8.		CEDAR	ALUMINUM	WEARDECK®	SURE-STEP®
Stock Size	Weight*	Price	Price	Price	Price
<b>LEG DOCKS</b>					
4' x 8'	49 lbs.	\$ 645	\$ 875	\$ 845	n/a
4' x 10'	58 lbs.	\$ 745	\$ 1,020	\$ 979	n/a
4'3" x 8'5"	103 lbs.	n/a	n/a	n/a	\$ 819
4'3" x 10'5"	125 lbs.	n/a	n/a	n/a	\$ 935
<b>WHEEL DOCKS</b>					
4' x 12'	95 lbs.	\$ 1,245	\$ 1,575	\$ 1,520	n/a
4'3" x 12'5"	149 lbs.	n/a	n/a	n/a	\$ 1,465

Dock pricing includes frame and removable decking. Wheel dock pricing includes (1) pair of wheels and axle assembly. The necessary assembly components are sold separately. \*Weights for docks do not include the decking with the exception of docks with Sure-Step® decking, which attaches directly to the dock frame and is not removable.

## Leg & Wheel Docks : Medium Duty Aluminum



see page 3 for details

Our medium duty aluminum frame leg and wheel docks offer superior strength and stability, featuring taller frames and longer and wider sections than our standard duty frames. Easy to install, the support stanchions are built into the frame and flush to the sides of the dock, allowing for an obstruction-free dock edge.



Medium duty aluminum docks with composite decking (special order color) and 6,000 lb. vertical boat lift with Sunbrella canopy (see pp. 54-57). Accessories include shallow water stairs, vertical fenders and solar post lites.

## Medium Duty Aluminum Leg & Wheel Docks

- Exceptionally strong, 7" tall aluminum frame
- Support stanchions built into the frame, for an obstruction-free dock edge
- Removable decking panels in cedar, composite or aluminum
- Ipe hardwood decking option also available

### Standard Duty vs. Medium Duty Frames

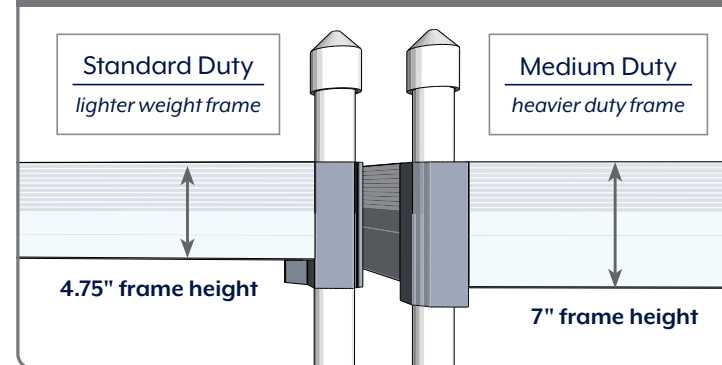

# Leg & Wheel Docks : Medium Duty Aluminum



Orwell, VT



Lake George, Ticonderoga, NY

Dock section used as a ramp.

6' x 10' sections with WearDeck decking in barefoot sand.



Lake Bomoseen, Castleton, VT

special order decking color



Optional triangle section for more deck space



Greensboro, VT

6 foot wide sections optimize deck space

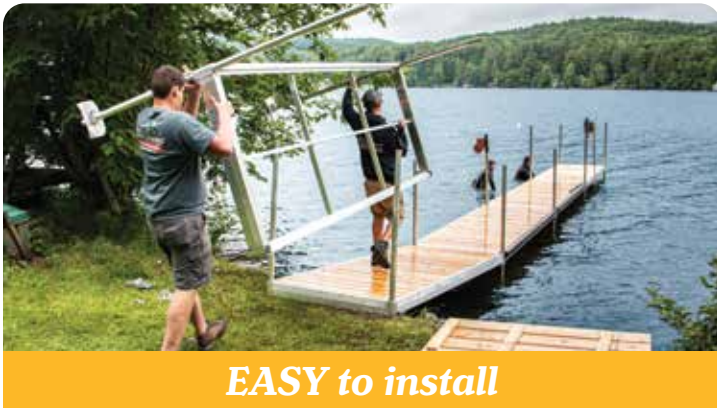

**EASY to install**

No sharp edges on underside of frames make our aluminum docks easy on the hands for carrying.



Greensboro, VT

6' x 10' sections with cedar decking

*Above: Dock sections are installed side-by-side to create a "T" shape.*



*Wheel docks easily roll in and out as the water fluctuates.*

## Leg & Wheel Docks : Medium Duty Aluminum



Above Left & Right : Our dock mounted kayak / canoe roller and pipe-mounted storage arms (see page 15) are great accessories for launching and storing your paddle crafts. See all our [dock accessories](#) on pages 8-18).





## Assembly Components

**Connector Clips**  
for connecting  
docks together  
**\$ 37** set of 2



**Safety Cap**  
for 1 1/2" pipe  
**\$ 5.<sup>50</sup>** each



**Aluminum  
Pipe 1 1/2"**  
cut to length  
pending  
water depth  
**\$ 6.<sup>95</sup>** per foot



**Footpad  
(aluminum)**  
**\$ 37** each



**Cross Braces**  
(optional)  
stabilizes docks  
in deeper water  
4 foot: **\$ 155**  
6 foot: **\$ 165**  
8 foot: **\$ 175**  
10 foot: **\$ 185**



Size based on distance between support pipe.



## Medium Duty Aluminum Leg & Wheel Docks

See decking & color  
choices on page 8.

Stock Size	Weight*	CEDAR	ALUMINUM	WEARDECK®
		Price	Price	Price
<b>LEG DOCKS</b>				
4' x 8'	75 lbs.	\$ 825	\$ 1,040	\$ 1,010
4' x 10'	89 lbs.	\$ 945	\$ 1,215	\$ 1,175
4' x 12'	100 lbs.	\$ 1,050	\$ 1,395	\$ 1,329
6' x 8'	93 lbs.	\$ 1,069	\$ 1,385	\$ 1,315
6' x 10'	111 lbs.	\$ 1,225	\$ 1,630	\$ 1,530
6' x 12'	125 lbs.	\$ 1,370	\$ 1,859	\$ 1,735
3' x 3' triangle corner	30 lbs.	\$ 470	\$ 495	\$ 485
<b>WHEEL DOCKS</b>				
4' x 16'	156 lbs.	\$ 1,860	\$ 2,279	\$ 2,199
6' x 16'	184 lbs.	\$ 2,099	\$ 2,749	\$ 2,569

Dock pricing includes frame and removable decking. Wheel dock pricing includes (1) pair of wheels and axle assembly. The necessary assembly components are sold separately. \*Weights for docks do not include the decking.

# Leg & Wheel Docks : Heavy Duty Steel Truss

Designed for exposed sites and rough water conditions, our heavy duty steel truss leg and wheel docks are incomparable for strength and durability. The heavy duty truss frame allows water to pass through the frame.



Peacham, VT

*Above: Steel truss leg docks with composite decking arranged in a "U" shape to create a boat slip.*



Steel truss wheel docks with cedar decking. 2' x 10' catwalk used as a ramp.

## Heavy Duty Steel Truss Leg & Wheel Docks

- Designed for exposed sites
- Heavy duty 9" galvanized steel truss frame with adjustable leg stanchions built into frame
- Removable decking in cedar or composite
- Ipe hardwood decking option also available
- 10 year limited warranty



*Above: Steel truss leg docks with cedar decking and our 2-craft storage rack (see page 15).*



Lake Champlain, VT

Dock section used as a ramp.

*Left & Below: Steel truss leg docks with 6-foot wide sections, cedar decking and our Launch Port Lift for launching kayaks/canoes — see page 11 in our **Paddle Products** Catalog.*



Watch a video and find out more at:  
[thedockdoctors.com/launch-port-lift](https://thedockdoctors.com/launch-port-lift)

# Leg & Wheel Docks : Heavy Duty Steel Truss



Ticonderoga, NY

Steel truss leg docks with 6' wide sections, cedar decking, and 5,000 lb. vertical boat lift with Sunbrella Canopy.



Shallow water stairs (see p. 18)



Aluminum stairs (see p. 19)



4' x 16' with "L"



Steel truss wheel docks with composite decking and 1,250 lb. vertical boat lift.



Willsboro, NY

Steel truss leg docks with composite decking and our lower access platform (see page 13).

## Assembly Components

### Connecting Brackets

each connection requires (4)

End-to-end: \$ 15 /ea

Side-by-side: \$ 15 /ea

Catwalk (3"): \$ 13 /ea

catwalk requires (2)

3" brackets & (2) truss end-to-end brackets



### Safety Cap

for 1 1/2" pipe

\$ 5.<sup>50</sup> each

### Galvanized

Pipe 1 1/2"

cut to length pending water depth

\$ 6.<sup>95</sup> per foot



### Footpad

(galvanized steel)

\$ 39 each



### Dock Panel Securing Cord

\$ 5.<sup>25</sup> set of 4



### Cross Braces

(optional)

stabilizes docks in deeper water

4 foot: \$ 155

6 foot: \$ 165

8 foot: \$ 175

10 foot: \$ 185



Size based on distance between support pipe.

4' x 10' Leg Dock  
with removable deck panels



4' x 16' Wheel Dock  
with removable deck panels



see page 3 for details



## Heavy Duty Steel Truss Leg & Wheel Docks

Stock Size	Weight*	See decking & color choices on page 8.	CEDAR	WEARDECK®
			Price	Price
<b>LEG DOCKS</b>				
4' x 8'	100 lbs.		\$ 960	\$ 1,145
4' x 10'	115 lbs.		\$ 1,030	\$ 1,260
6' x 8'	125 lbs.		\$ 1,240	\$ 1,480
6' x 10'	145 lbs.		\$ 1,315	\$ 1,625
2' x 10' catwalk (std duty**)	75 lbs.		\$ 549	\$ 659
3' x 3' triangle corner	19 lbs.		\$ 339	\$ 367
<b>WHEEL DOCKS</b>				
4' x 16'	208 lbs.		\$ 2,049	\$ 2,389
6' x 16'	265 lbs.		\$ 2,315	\$ 2,780
4' x 16' with 4' x 8' L	316 lbs.		\$ 3,020	\$ 3,525
6' x 16' with 4' x 8' L	373 lbs.		\$ 3,289	\$ 3,889

Dock pricing includes frame and removable decking. Wheel dock pricing includes (1) pair of wheels and axle assembly. The necessary assembly components are sold separately. \*Weights for docks do not include the decking. \*\*Catwalk shown bottom right page 32.

## Leg & Wheel Docks : Mega Duty Steel Truss



Designed for use in rough and deep water applications, our mega duty steel truss leg and wheel docks feature taller frames, longer and wider sections, and larger diameter upright supports than our heavy duty steel truss dock systems. Available in two stock sizes (or contact us for custom dock size options).

## Mega Duty Steel Truss Leg & Wheel Docks

- Designed for use in rough & deep water applications
- 11" tall galvanized steel truss frame
- 3" diameter upright supports
- Stocked in 6' x 20' & 8' x 20' sizes (custom sizes available)
- Adjustable leg stanchions built into frame
- Removable decking in cedar or composite
- Ipe hardwood decking option also available

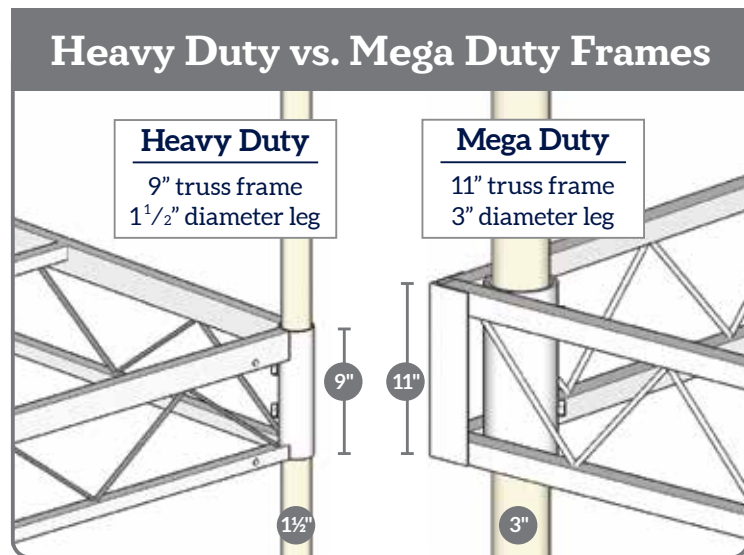

*Above: Mega dock with WearDeck decking in Barefoot Gray and our Ultimate Boat Lift with Sunbrella Canopy (see pages 60-63).*

# Leg & Wheel Docks : Mega Duty Steel Truss



Shelburne, VT



*Above: Mega dock with Ipe hardwood decking and our 9,000 lb. Ultimate Vertical Boat Lift.  
Above Right: Our aluminum gangway as a shore-access for the above dock.*



*Our mega dock used as a shoreside access & mount to a custom floating dock (see our [Custom Catalog](#)).*



## Assembly Components

### Connecting Brackets

each connection requires (4)  
\$ 27 each



### Safety Cap

for 3" pipe  
\$ 6.95 each



### Galvanized Pipe 3"

cut to length pending water depth  
\$ 12.95 per foot



### Footpad

(galvanized steel)  
\$ 52 each

### Dock Panel Securing Cord

\$ 5.25 set of 4



### Cross Braces

(not shown, optional stabilizes docks in deeper water

\$ 185 (6' wide docks)  
\$ 195 (8' wide docks)



### Mega Dock Adjustment Kit

adjust the level of your dock with this kit that slides over the 3" leg pipe

\$ 465 pair



## Mega Duty Steel Truss Leg & Wheel Docks

See decking & color choices on page 8.

Stock Size	Weight*	CEGAR	WEARDECK®	IPE hardwood
		Price	Price	available as a special order.
<b>LEG DOCKS</b>				
6' x 20'	418 lbs.	\$ 3,990	\$ 4,530	call for quote
8' x 20'	490 lbs.	\$ 5,340	\$ 6,100	call for quote
<b>WHEEL KITS</b>				
for 6' wide docks: \$ 479				
for 8' wide docks: \$ 499				

Dock pricing includes frame and removable decking. Wheel dock pricing includes (1) pair of wheels and axle assembly. The necessary assembly components are sold separately. \*Weights for docks do not include the decking.

# Floating Docks : Medium Duty Aluminum

Castleton, VT



Aluminum Ladder  
(see p. 18)



Our medium duty aluminum floating docks feature our “aluminum track” frame, allowing for easy mounting of hardware and accessories. These pre-manufactured “stock” docks are readily available for pick up, delivery or installation and are designed to be easily installed for the do-it-yourselfer.

## Medium Duty Aluminum Floating Docks

- Used in residential & light commercial applications
- Exclusively designed frame by The Dock Doctors®
- Universal track-style 5" tall aluminum frame allows for easy mounting of hardware & accessories
- Removable decking panels in cedar, aluminum or composite
- Ipe hardwood decking also available
- Black polyethylene flotation filled with expanded polystyrene



Schroon Lake, NY

Dock section used as a ramp.

Above: Aluminum floating dock with WearDeck composite decking and solar post lites (see p. 16). 4' x 12' dock section used as a ramp.



Spud Pole Anchor

Our unique float frame and hinge-system allow for a seamless transition from gangway/ramp to dock (no step down) & adjusts to fluctuating water levels.



Float Frame

Charlotte, VT



Above: Aluminum floating dock and 3' x 24' aluminum gangway with cedar decking.

# Floating Docks : Medium Duty Aluminum



Barefoot Grey Decking

*Above: Aluminum floating dock and gangway with WearDeck® decking. Shown with YakPort kayak launch (see p. 44) and aluminum ladder (see p. 18). Anchored with our chain tube anchor mount (inset) and our custom pile dock as a shore hitch.*



Barefoot Sand Decking

Ludlow, VT



Plymouth, VT

4' x 12' medium duty aluminum floating docks with edge fender



**Our heavy duty aluminum docks** with a 7" tall frame are ideal for sites with more exposure (see pages 4-5 & 51-53 in our Custom Catalog).

# Assembly Components

## Hinge Connector Kits

Hinge connector kits include bushing, stainless steel pins, wear and dampener system and protective cap (cap not shown).



**\$ 173**  
(for 4' wide docks)

**\$ 179**  
(for 6' wide docks)

**\$ 185**  
(for 8' wide docks)



**Anchor Mounts:**  
**Spud Pole \$ 235**  
pipe sold separately



**2" Galvanized Pipe**  
**\$ 10.<sup>50</sup> / ft.**



**Chain Tube \$ 125**  
chain for anchoring  
sold separately

**3/8" Galvanized Chain**  
**\$ 4.<sup>50</sup> / ft.**

4' x 12' Medium Duty Aluminum Floating Dock with removable deck panels



## Medium Duty Aluminum Floating Docks

See decking & color choices on page 8.

Stock Size	Weight*	CEDAR	ALUMINUM	WEARDECK®
		Price	Price	Price
<b>FLOATING DOCKS</b>				
4' x 12'	200 lbs.	\$ 1,649	\$ 1,949	\$ 1,898
4' x 16'	260 lbs.	\$ 2,069	\$ 2,479	\$ 2,389
6' x 12'	256 lbs.	\$ 2,229	\$ 2,669	\$ 2,545
6' x 16'	368 lbs.	\$ 2,789	\$ 3,389	\$ 3,219
8' x 12'	352 lbs.	\$ 2,748	\$ 3,349	\$ 3,199
8' x 16'	503 lbs.	\$ 3,395	\$ 4,210	\$ 3,999
<b>RESIDENTIAL GANGWAY</b>		CEDAR	ALUMINUM	WEARDECK®
3' x 24'	357 lbs.	\$ 3,498	\$ 3,899	\$ 3,799
<b>COMMERCIAL GANGWAYS</b> available in any length/width with minimal time frames.				

Pricing includes frame, decking and flotation. Anchoring, connecting hardware and shore mount sold separately.

Note: Docks used as a shore ramp may require adjustable float frame and shore connection pending layout.

Ipe hardwood decking option available. \*Weights do not include the decking.

# Floating Docks : Connect-A-Dock



- Wood grain anti-skid surface
- Ultra tough, polyethylene construction
- 1000 Series provides 8" of freeboard
- 2000 Series provides 17" of freeboard



Waterville Valley, NH

Connect-A-Dock floating docks accommodate a variety of uses with many modular sizes and freeboard heights.

*Above: "1000 Series" low profile system with Dock Doctors floating dock as a ramp and shore hitch.*



Tupper Lake, NY

*Above: "2000 Series" higher profile system with Dock Doctors 4' x 16' floating dock with float frame as a ramp and shore hitch.*



grab bars (short)

overhead bar

Shown connected to 2000 series floating dock section.  
**Outside Dimensions:** 48" wide x 60" long x 22" high.  
**Inside Dimensions:** 34" wide x 17" high.  
 Accommodates crafts up to 34" wide. Weight: 99 lbs.

## YAKPORT

The YAKport launch makes getting in and out of the water easy for beginners or experienced users. The YAKport can be installed to virtually any floating or fixed dock and can be used for kayaks, canoes or stand up paddle boards (SUP) up to 34" wide. Made from highly durable UV protected polyethylene.

**YakPort: \$638 MSRP**

### YakPort Dock Connection Kits: *(additional anchoring may be required)*

Connect-A-Dock 1000 Series.....	<b>\$204</b>
Connect-A-Dock 2000 Series.....	<b>\$172</b>
Fixed Docks.....	<b>\$172</b>
Floating Docks (low profile).....	<b>\$124</b>
Floating Docks (high profile).....	<b>\$195</b>

### YakPort Optional items:

Overhead assist bars.....	<b>\$159</b>
Yak "grab" bars (long).....	<b>\$200 each</b>
Yak "grab" bars (short).....	<b>\$110 each</b>



1000 series float section



1000 series corner

see page 3 for details



2000 series float section



2000 series corner



Above Left: YakPort with overhead bar and short grab bars.

Above Right: "2000 Series" higher profile system as an extension to an existing dock.

## Connect-A-Dock Floating Docks

Below is a list and pricing of the most popular sizes - please contact us for a complete list of all Connect-A-Dock® product, anchoring and accessories available.

Series	Model	Weight*	Size	Price Ea
1000	FS1030	50 lbs.	45" × 30" Float Section	\$ 352
1000	FS1060	110 lbs.	45" × 60" Float Section	\$ 700
1000	FS1120	400 lbs.	90" × 120" Float Section	\$2,170
1000	CFS1010	30 lbs.	44" × 33" Corner	\$ 286
1000	FC1020		Float Connector (1000 series)	\$ 47
2000	FS2120	420 lbs.	72" × 120" Float Section	\$2,170
2000	FS2096	230 lbs.	48" × 96" Float Section	\$1,300
2000	CFS2022	75 lbs.	48" × 67" Corner	\$ 466
2000	FS2024	70 lbs.	24" × 48" Float Section	\$ 404
2000	FC2020		Float Connector (2000 series)	\$ 86
1000	PC1010		Pole Connector (for 2" pipe)	\$ 68
2000	PC2022		Pole Connector (for 2" pipe)	\$ 90

# Floating Docks : Heavy Duty Aluminum Paddle Docks



Oseetah Lake, NY



11-12" freeboard

Our aluminum-frame paddle docks feature heavy-duty aluminum frames suitable for commercial or residential applications. Their modular design allow for a variety of layout options.



# Heavy Duty Aluminum Paddle Docks

- 7" Aluminum Track Frame with 10"- 12" freeboard (approximate – pending sections, size & decking choices)
- Heavy duty, stainless-steel connection hinges
- Optional powder coated frame
- Cedar decking, or upgrade to optional Ipe or composite
- Black polyethylene flotation filled with expanded polystyrene
- Optional marine-grade black vinyl edge fender



Optional angled ladder



Spud pole anchor example



10' x 16' paddle dock and 8' x 16' ramp section with Ipe decking.



Paddle dock with Ipe decking and angled ladder (see page 49).

Photo courtesy of:



## Paddle Docks

Heavy Duty Aluminum

Standard Size	Price
8' x 20'	as low as <b>\$6,145</b>
10' x 20'	as low as <b>\$7,499</b>
8' x 16' ramp section	as low as <b>\$4,690</b>

Custom sizes and wider ramps available. Standard pricing includes aluminum frame, cedar decking and flotation. Site conditions, exposure, anchoring details and ramp requirements to be determined for final pricing.

# Floating Docks : Heavy Duty Aluminum Rowing Docks



Our heavy-duty, aluminum-frame rowing docks feature a modular design for a variety of layout options. Designed for commercial or residential applications.



Saratoga Springs, NY



- 7" Aluminum Track Frame with 6"- 8" freeboard
- Heavy duty, stainless-steel connection hinges
- Modular track-style frame allows easy addition of optional components and multiple layout options
- Black polyethylene flotation filled with expanded polystyrene
- Cedar decking, or upgrade to optional Ipe or Composite
- Optional marine grade black vinyl edge fender
- Optional debris diverter protects the dock from floating debris often seen in river settings

## Rowing Docks

Heavy Duty Aluminum

Standard Size	Price
8' × 20'	as low as \$6,145
10' × 20'	as low as \$7,499
8' × 16' ramp section	as low as \$4,690
8' × 20' flared ramp section	as low as \$6,249

Custom sizes and wider ramps available. Standard pricing includes aluminum frame, cedar decking and flotation. Site conditions, exposure, anchoring details and ramp requirements to be determined for final pricing.

Accessories & Options	Price
<b>A</b> Wheel Kit	\$ 875 / set
<b>B</b> Angled Dock Ladder (aluminum)	\$ 410

Items not shown:

Debris diverter - 8' long	as low as \$2,909
Debris diverter - 10' long	as low as \$3,629
Hinge connections	as low as \$355
Edge Fender (black vinyl, installed on dock)	\$10. <sup>95</sup> / lineal foot



City of Dover,  
Cochecho River, Dover, NH

Our aluminum frame rowing dock with 38' × 7' aluminum gangway and our ADA accessible commercial launch with ADA transfer platform.



Axle & Wheel mounts for seasonal installation & removal.



Angled ladder (aluminum).



Rondout Rowing Club  
Kingston, NY

# Floating Docks : Connect-A-Dock® Rowing & Paddle Docks

The Dock Doctors are the exclusive distributors of *Connect-A-Dock* products for New England and New York. Please contact us for pricing and details.

Skidmore College, Saratoga Springs, NY



## Applications ideal for Connect-A-Dock products:

- Rowing / Sculling docks
- Small craft access for canoes & kayaks
- Floating dock slip in calm bodies of water
- Walkway in marsh wetlands





## Connect-A-Dock benefits:

- Modular design
- Easy to install
- UV protected
- Salt water safe
- Environmentally friendly
- Does not contain CCA
- 8 year product warranty



10' x 22'6" section  
1000 series rowing system

**FREE DELIVERY**  
see page 3 for details



### Rowing Docks

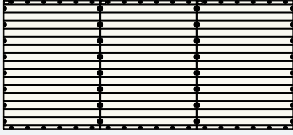

Standard Size	Price
7'6" x 20' <b>1000 Series Rowing System</b> 	starting at <b>\$4,622*</b> (including connectors)
10' x 22'6" <b>1000 Series Rowing System</b> 	starting at <b>\$7,262*</b> (including connectors)

**Quantity Discounts Available**

\*Sample pricing does not include any anchoring, ramp to shore, etc.  
Please call for a free estimate.

# Boat Lifts : PWC Lifts & Ports



see page 3 for details

Model Capacity	PL1000 1,000 lbs	PL1200 1,200 lbs
Max. Beam	64"	70"
Lifting Height	46"	46"
Bed Length	72"	96"
Min. Water Depth	9"	10"
Overall Width	72"	80"
Adjustable Legs	(4) @ 18"	(4) @ 18"
Shipping Weight	155 lbs	257 lbs
<b>MSRP</b>	<b>\$ 1,768</b>	<b>\$ 2,347</b>
<b>Sale Price</b> <i>(assembled)</i>	<b>\$ 1,710</b>	<b>\$ 2,230</b>
<b>Sale Price</b> <i>(unassembled)</i>	<b>\$ 1,590</b>	<b>\$ 2,110</b>

## PWC & Small Craft Lifts

- 1,000 lb. & 1,200 lb. capacity cantilever models
- Stainless steel hardware & cables
- Polymer pulley sheaves prolong cable life
- Dual mounting winch (left or right side)
- 15 Year Limited Warranty
- 1,250 lb. vertical & 2,000 lb. hydraulic models also available (see Vertical Lift section on p. 55 or Hydraulic Lift section on p. 58)
- Manufactured by RGC®

## Safe harbor for your personal watercraft!

The Connect-A-Port XL6 by **Connect-A-Dock®** with universal hull support makes docking your personal watercraft safe and easy! Simply idle up and drive on to dock and roll-off to launch.



### Model: CAPXL6

72" × 156" × 23"

(182.88 cm × 396.24 cm × 58.42 cm)

Maximum flotation: 2000 lbs. (907.2 kg)

Weight: 375 lbs. (170.1 kg)

**Price: \$ 1,950\***

*\*Price does not include attachment or connecting hardware to dock system.*

## Connect-A-Port Options

- Attachment kit for fixed & floating docks
- Connecting hardware to link multiple units (side by side)
- Bow stop winch (to help secure your PWC in rougher water conditions)

### Dock Connection Kits:

Connect-A-Dock kit (part# AKS1212)..... \$ 160

Fixed dock kit (part# PC1212)..... \$ 150

Floating dock kit (part# AHK1212)..... \$ 150

### Connecting multiple units:

Side-by-side kit (part# AKC1212)..... \$ 216



The Dock Doctors are the exclusive distributors of **Connect-A-Dock products** for New England and New York. Please contact us for pricing and details.

## Connect-A-Port Features & Benefits

find out more at: [www.thedockdoctors.com/pwc-port](http://www.thedockdoctors.com/pwc-port)

- Accommodates 1, 2, 3 and 4-place personal watercrafts
- Ultra tough, polyethylene construction
- Multiple rollers
- Patented bow stop
- Cable & clip for securing PWC
- Anti-skid walk area
- Universal hull support
- Front or side mounting
- 5-Year product warranty

## Boat Lifts : Vertical Lifts



4500 lb. boat lift shown with a ski boat

### Vertical boat lifts for any size and style boat:

- All stainless steel hardware & cables
- High lifting range
- Minimal water required
- Manufactured by RGC®
- 15 year limited warranty
- Delivery & installation available



8000 lb. boat lift with double bunk system for larger boats



4500 lb. boat lift with pontoon cradle kit



6000 lb. boat lift with tritoon cradle kit



Small craft vertical lift with higher lift height vs. cantilever PWC lift



## Aluminum Vertical Boat Lifts

Model #	Weight Capacity	Max. Beam	Overall Width	Overall Length	Lifting Height †	Min. Water	Shipping Weight	MSRP Price	Dock Doctors Price (assembled)	Dock Doctors Price (unassembled)
VL1250*	1,250 lbs	65"	73"	82"	75"	8.5"	233 lbs	\$ 2,977	\$ 2,905	\$ 2,679
VL20100*	2,000 lbs	100"	108"	100"	66"	9.5"	249 lbs	\$ 3,777	\$ 3,745	\$ 3,399
VL45108	4,500 lbs	108"	116"	116"	68"	8"	507 lbs	\$ 6,210	\$ 5,925	\$ 5,465
VL45116	4,500 lbs	116"	124"	116"	68"	8"	510 lbs	\$ 6,417	\$ 6,105	\$ 5,645
VL45116 T	4,500 lbs	116"	124"	116"	80"	8"	523 lbs	\$ 6,622	\$ 6,085	\$ 5,629
VL50124 T	5,000 lbs	124"	133"	132"	80"	9"	597 lbs	\$ 7,140	\$ 6,745	\$ 6,285
VL60124 T	6,000 lbs	124"	133"	132"	80"	9"	663 lbs	\$ 7,498	\$ 6,895	\$ 6,375
VL80124 T***	8,000 lbs	124"	133"	132"	78"	11"	777 lbs	\$ 11,353	\$ 10,280	\$ 9,650
VL100132***	10,000 lbs	132"	147"	158"	78"	13"	1217 lbs	\$ 17,672	\$ 15,799	\$ 14,999



see page 3 for details

All pricing is F.O.B. our facility in Ferrisburgh, VT. Prices are for in stock product only. Additional freight charges may apply for special orders. Boat lift prices include (4) adjustable 29" legs with footpads and carpeted pressure treated bunks. Manual handwheel is included with non-electric models. \*Lift includes 18" legs. \*\*Bunks not included with pontoon lift - add desired kit from kits listed at bottom of page. †\*\*\*Lifts include AC Direct Drive with remote control and double carpeted wood bunks. † Measured from top of load tubes to bottom of feet when adjustable legs are fully retracted. Measurements are approximate.

## Pontoon & Tritoon Cradle Kits

Lift Model	Pontoon Cradle & Guide Kit	Tritoon Cradle & Guide Kit	Pontoon Deck Kit
4000-4500	\$ 1,025	\$ 1,292	\$ 671
5000	\$ 1,127	\$ 1,446	\$ 687
6000	\$ 1,240	\$ 1,579	\$ 687

Pontoon Cradle & Guide Kit



Pontoon Deck Kit



# Boat Lifts : Vertical Lift Accessories

## A Vertical Lift Guides & Extension Legs

Lift Models	Carpeted Guides		Other Options	
	regular adjusts from 16"-25 ½" high	tall adjusts from 25"-34 ½" high	Ext. Legs 4' pair	Ext. Legs 6' pair
3500	\$ 687	\$ 717	\$ 267	\$ 338
4500	\$ 687	\$ 717	\$ 267	\$ 338
5000	\$ 712	\$ 723	\$ 267	\$ 338
6000	\$ 712	\$ 723	\$ 267	\$ 338
8000	n/a	\$ 825	\$ 267	\$ 338
10,000	n/a	\$1,097*	\$349	\$ 390

\*Tall guides for 10,000 lb. boat lift adjust 25" - 43 ½". Credit \$95 for a pair of 29" legs if upgrading to longer extension legs with the purchase of a new boat lift.

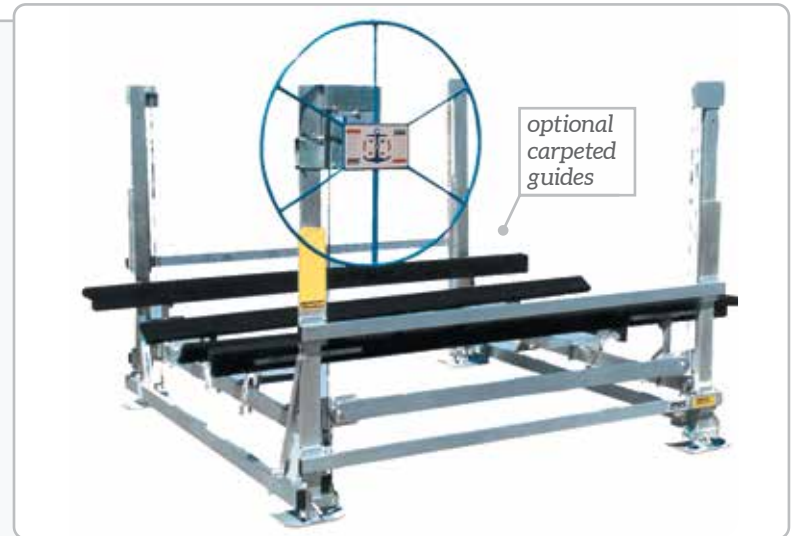

## Electric Drive Units

Lift Models	AC Drive Systems				DC Drive Systems		
	B Direct	Direct with remote	Extreme Max Manual	Extreme Max with remote	Direct with remote	Extreme Max Manual	C Extreme Max with remote
3500	\$ 1,942	\$ 2,727	\$ 1,164	\$ 1,635	\$ 2,891	\$ 1,164	\$ 1,646
4500	\$ 1,983	\$ 2,839	\$ 1,164	\$ 1,635	\$ 2,891	\$ 1,164	\$ 1,646
5000	\$ 1,983	\$ 2,839	\$ 1,164	\$ 1,635	\$ 2,891	\$ 1,164	\$ 1,646
6000	\$ 1,886	\$ 2,839	\$ 1,164	\$ 1,635	\$ 2,901	\$ 1,164	\$ 1,646

Note: Drives listed are for lifts with R18 winches only. Please inquire for pricing and information on electric drives for D&L winches. Credit \$175 for handwheel with the purchase of a direct drive and a new boat lift.



Direct A/C drive with manual switch



Extreme Max D/C drive with remote control and solar power box

- B Direct Drive** This direct drive uses an industrial oil bath gear reducer and motor with a stainless steel cover which connects to the standard winch. Available with a remote control option. Available as an AC or DC unit.
- C Extreme Max Drive System** Manual key or optional remote control operation with a backup bit for manual operation of the unit in the event of a power outage. Comes complete with mounting kit.
- D VL Solar Power Box** Portable solar power source for waterfront owners with no electricity. Lightweight white fiberglass box holds (2) deep cycle batteries with a power source on/off switch. Available as solar or with an A/C trickle charger. **Solar charged: \$ 1,339 A/C charged: \$ 1,289**



Above: "Pacific Blue" canopy.  
Left: "Heather Beige" canopy.



Traditional canopy shown above & left.  
Please visit our website for other style options available:  
[www.thedockdoctors.com/canopies](http://www.thedockdoctors.com/canopies)

## Traditional Sunbrella® Boat Lift Canopies

Lift Models	Description	(unassembled)
		Price
35108/45108	21' × 108"	<b>\$ 3,615</b>
35108/45108	24' × 108"	<b>\$ 3,902</b>
45116	24' × 116"	<b>\$ 3,967</b>
45116	26' × 116"	<b>\$ 4,081</b>
45116	28' × 116"	<b>\$ 4,468</b>
40124/50124/60124/80124	24' × 124"	<b>\$ 4,071</b>
40124/50124/60124/80124	26' × 124"	<b>\$ 4,256</b>
40124/50124/60124/80124	28' × 124"	<b>\$ 4,658</b>
40124/50124/60124/80124	30' × 124"	<b>\$ 4,817</b>
100132	32' × 132"	<b>\$ 5,403</b>

Prices include aluminum canopy frame & fabric in standard colors:  
● Pacific Blue ● Cadet Grey ● Forest Green ● Heather Beige ● Slate  
 Signature colors available as a special order at an additional cost.  
 Additional costs for shipping may apply for canopies not in stock.

## Boat Lift Installation & Removal Tools

Make the seasonal installation and removal of your boat lift easier with a wheel kit and/or air bag lift system.

### A Boat Lift Wheel Kits

Specifically designed for use with RGC® boat lifts and can be modified for use with hydraulic boat lifts. Includes a pair of welded galvanized steel mounting brackets and a pair of heavy duty polyethylene wheels (8K-10K kit comes with 4 wheels).

- BLW2045 (fits 2,000 - 4,500 lb. lifts): **\$ 325 / pair**
- BLW5060 (fits 5,000 - 6,000 lb. lifts): **\$ 340 / pair**
- BLW5060 (fits 8,000 - 10,000 lb. lifts): **\$ 475 / pair**



### B Air Bag Lift Kits

Inflatable 250 and 500 lb. capacity air bags designed to float your boat lift for seasonal installation and removal. Ideal when used in conjunction with a wheel kit (see photo on left).

- 250 lb. capacity: **\$ 290 / airbag**
- 500 lb. capacity: **\$ 415 / airbag**

Each kit includes (1) airbag, with a connecting kit (carabiner and strap). Airbag inflates with air compressor with a standard 1/4" NPT air fitting.

# Boat Lifts : Hydraulic Lifts



- Available from 2,000 to 12,000 lb. capacity
- Stainless steel hardware
- Aluminum hydraulic cylinders with stainless steel fittings and hose assemblies
- Full length vinyl bunks
- Pontoon & Tritoon kits available
- Solar or AC charging options
- Manufactured by RGC®
- 15 year limited warranty



## Hydraulic Aluminum Lifts

Model #	Weight Capacity	Max. Beam	Lifting Height †	Min. Bunk Height	Shipping Weight	Lifting Speed UP (seconds)	Lifting Speed DOWN	Hydraulic Cylinders	MSRP	(assembled) Dock Doctors Price	(unassembled) Dock Doctors Price
HL200-48	2,000 lbs.	65"	48"	24"	235 lbs.	30 sec	20 sec	1	\$ 6,618	\$ 6,245	\$ 6,038
HL40120-60	4,000 lbs.	120"	60"	26"	542 lbs.	65 sec	45 sec	2	\$ 9,740	\$ 9,055	\$ 8,765
HL50120-60	5,000 lbs.	120"	60"	28.5"	680 lbs.	45 sec	45 sec	2	\$ 10,372	\$ 10,220	\$ 9,930
HL70120-60	7,000 lbs.	120"	60"	30"	760 lbs.	90 sec	50 sec	2	\$ 12,246	\$ 11,065	\$ 10,775
HL90120-60	9,000 lbs.	120"	60"	31"	997 lbs.	110 sec	75 sec	4	\$ 16,240	\$ 14,255	\$ 13,965
HL120132-60	12,000 lbs.	132"	60"	40"	1,500 lbs.	80 sec	90 sec	4	\$ 23,156	\$ 19,880	\$ 19,450

Prices above include (4) 3' legs, battery, AC charger & remote control. For solar power upgrade add \$120 or \$150 for 9k & 12k models. All pricing is F.O.B. our facility in Ferrisburgh, Vermont. Prices are for in stock product only. Additional freight charges may apply for special orders. See page 3 for delivery information. † Measured from top of bunks to bottom of feet when adjustable legs are fully retracted. Measurements are approximate.

Pontoon and Tritoon kits available for Hydraulic Lifts - contact us for options and pricing.

## Elevated Power Box Stand

This stand provides protection for your power box from heavy wave action or high water. Aluminum frame provides 15" of height above the deck surface. **\$ 259**

Power box not included in price.



## HL Boat Lift Accessories: Guides, Extension Hoses and Extension Legs

Lift Model	Aluminum & Wood Guides	Aluminum Rollers* (for guides)	Stainless Ext. Hose 12' pair	Stainless Ext. Hose 20' pair	Ext. Legs 5' pair	Ext. Legs 7' pair w/ bracing	Ext. Legs 9' pair w/ bracing
4000	\$ 1,281	\$ 123	\$ 472	\$ 543	\$ 277	n/a	n/a
5000-7000	\$ 1,322	\$ 123	\$ 472	\$ 543	\$ 277	\$ 892	\$ 1,035
9000	\$ 1,363	\$ 123	\$ 472	\$ 543	\$ 277	\$ 892	\$ 1,035
12,000	\$ 3,260^	\$ 123	n/a	n/a	\$ 277	\$ 1,046	\$ 1,179

\* The aluminum rollers are a recommended option for the aluminum guides. Credit \$160 for 3' legs if upgrading to longer extension legs with the purchase of a new boat lift. ^Guides for 12K lift model are available in aluminum and vinyl only.



Traditional canopy shown above. Please visit our website for other style options available: [www.thedockdoctors.com/canopies](http://www.thedockdoctors.com/canopies)

## Traditional Style Hydraulic Lift Canopies

Size	Price
24' x 124" Canopy	\$ 4,071
26' x 124" Canopy	\$ 4,256
28' x 124" Canopy	\$ 4,658

Note: Prices include standard color Sunbrella® Fabric (● Pacific Blue, ● Cadet Grey, ● Forest Green, ● Heather Beige & ● Slate). Optional and signature colors are available as a special order (additional cost).



## Canopy Leg Kits

Size	Price
4' Canopy Leg Kit with 8' posts	\$ 1,076
6' Canopy Leg Kit with 8' posts	\$ 1,240
8' Canopy Leg Kit with 8' posts	\$ 1,486

All pricing is F.O.B. our facility in Ferrisburgh, VT. Prices are for in stock product only. Additional freight charges may apply for special orders.

## Boat Lifts : Ultimate Vertical Lifts

Lake Champlain, Shelburne, VT



24,000 lb. capacity Ultimate Lift - shown right with the modular sections being loaded for delivery.

Ideal for boats from 6,000 to 32,000 lbs, our Ultimate Vertical Boat Lifts are manufactured with industrial quality hot-dipped galvanized steel. This lift is designed to be used in shallow, deep and fluctuating water applications. The 12,000 lb. and larger models are custom fabricated in modular sections (as shown in right photo) for ease of seasonal handling.



# Ultimate Vertical Boat Lifts

by The Dock Doctors

- Vertical lifts from 6,000 lb. to 32,000 lb. capacity
- 9 ft. standard lift height (other heights available)
- Great for shallow or deep water applications
- Adaptable to boathouses for use with permanent docks
- High lift for rough water & fluctuating water levels
- Portable/seasonal if necessary: 12,000 lb. & larger models fabricated in modular sections for ease of seasonal handling
- Industrial quality hot dipped galvanized steel construction, stainless steel cables & galvanized fasteners
- Custom heights, widths & lengths are available to accommodate your boat & location



*Above: 18,000 lb. capacity Ultimate Lift with custom bunks for catamaran hull.*



*Above: 18,000 lb. capacity Ultimate Lift with custom canopy.*

## Boat Lifts : Ultimate Vertical Lifts



24,000 lb. capacity Ultimate Lift with custom front end bow stop and oil bath drive upgrade.



Our sliding boarding step easily slides and retracts so you can safely board your boat from your dock.

**Sliding Boarding Step \$915**

### We can deliver and install your boat lift



6000 lb. capacity Ultimate Lift during installation with our workboat and service crew.



12,000 lb. capacity Ultimate Lift installed in a slip within a boathouse with standard vertical guides & upgraded oil bath drives.



## Dock Doctors® Ultimate Vertical Boat Lifts

Model #	Capacity	# of Drives	Maximum Beam	Lifting Height	Overall Width	Overall Length	Price*
<b>STOCKED MODELS</b>							
6000	6,000 lbs.	2	9'	9'	11'	12'	<b>\$ 12,900</b>
9000	9,000 lbs.	2	10'	9'	12'	13'	<b>\$ 14,500</b>
<b>CUSTOM MODELS</b>							
12000	12,000 lbs.	4	10' 7"	8' 9"	13'	14' <i>starting at</i>	<b>\$ 26,900</b>
18000	18,000 lbs.	4	11' 6"	8' 9"	14'	16' <i>starting at</i>	<b>\$ 31,900</b>
24000	24,000 lbs.	4	13'	8' 11"	16'	18' <i>starting at</i>	<b>\$ 39,900</b>
32000	32,000 lbs.	4	14'	8' 11"	17'	20' <i>starting at</i>	<b>\$ 44,900</b>
Auto Stop System ( <i>recommended option</i> )							<b>\$ 1,035</b>

### Custom sizes are available.

\*Prices above include Gem remote control, sealed bearing and grooved cable winders, AC drives, (4) 7' vertical guide poles with PVC sleeves, (4) wheel mounts, (4) 24" adjustable legs and heavy-duty carpeted bunks. Optional oil bath drives and full length guide-ons are available. Please inquire for pricing.

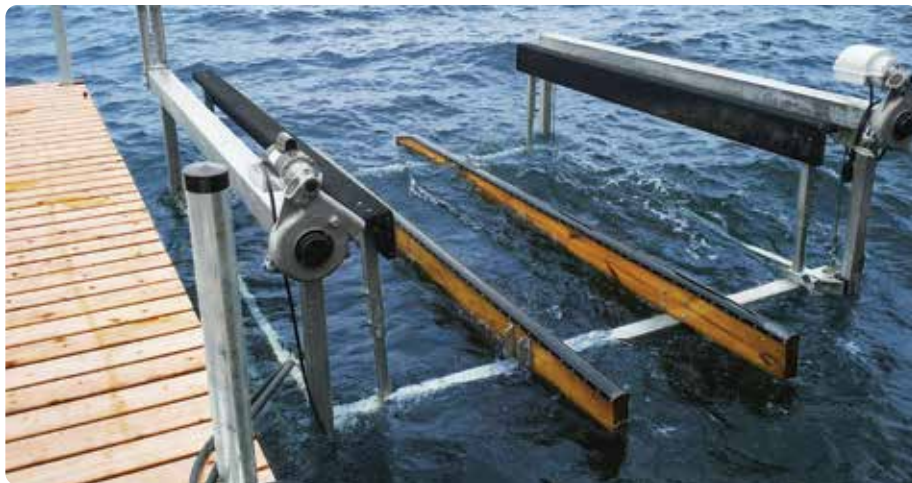

6,000 lb. capacity Ultimate Lift showing optional full length carpeted guides & upgraded oil bath drives.



9,000 lb. capacity Ultimate Lift with standard flat plate AC drives.

# Boat Lifts : Boathouse Lifts, Speciality Lifts, Custom Canopies

We custom fabricate Lifts for all types of sites & situations

For more details on our custom boat lifts see pages 28-29 in our custom catalog or visit our website at: [www.thedockdoctors.com/custom-boat-lifts](http://www.thedockdoctors.com/custom-boat-lifts)



*Above: Boathouse Lifts - are custom built to be installed in new or existing boathouses.*



*This elevator style lift is ideal for sites with deep water & a quick drop off.*



*Our Ultimate Lift customized to attach to the shore with galvanized lift arms allowing it to be raised for winter storage.*



*Seaplane lift utilizing a stock hydraulic lift with a custom turntable platform.*



Canopy mounted to dock

*Custom canopy mounts to attach a standard RGC® canopy to a stationary dock system.*

# Installation & Removal Service - Let the Waterfront Specialists do it for you!

*We provide service to all areas in the Northeast*



Living in the Northeast often has the added responsibility of removing and installing your dock system every year. Take the worry and hassle away with **The Dock Doctors® seasonal service plan**, and have the assurance that your system will be taken care of with the utmost quality and safety in mind.

The Dock Doctors 1-800-870-6756 [www.thedockdoctors.com](http://www.thedockdoctors.com)

Our portable workboats from 25'-32' in length allow us to provide installation for our products throughout the Northeast.

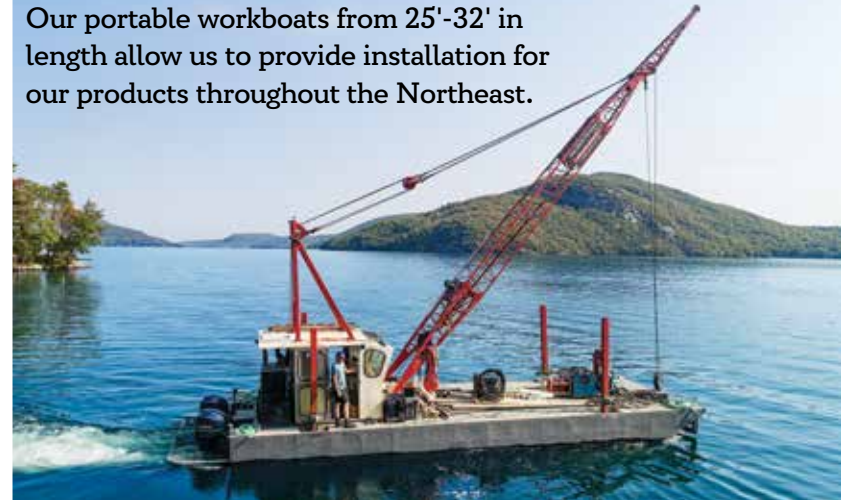

Seasonal Install & Removal Service 65

# The Dock Doctors<sup>®</sup> LLC

Waterfront Specialists



1984-2021  
**37 YEARS'**  
experience



Take a virtual tour of our facility at:  
[www.thedockdoctors.com/tour](http://www.thedockdoctors.com/tour)

**800-870-6756**  
[www.thedockdoctors.com](http://www.thedockdoctors.com)  
[info@thedockdoctors.com](mailto:info@thedockdoctors.com)

**Vermont Showroom & Manufacturing Facility**  
19 Little Otter Lane, Route 7, Ferrisburgh, VT 05456



Open  
year-round!

**Open Year-Round**

Monday-Friday: 9am-4:30pm

Saturday: 9am-1pm (April 10th thru July 24th)

Showrooms closed Memorial Day Weekend and 4th of July

**Lake Placid / Saranac Lake Showroom**

876 State Route 86, Ray Brook, NY 12977



Open  
Jun 1 - Aug 28

**Open Seasonally: June 1st through August 28th**

Tuesday-Friday: 10am-4:30pm

Saturday: 9am-1pm

Showrooms closed Memorial Day Weekend and 4th of July