

The Dock Doctors[®] LLC

Waterfront Specialists

2019
STOCK
CATALOG

Made in



LEG DOCKS

FLOATING DOCKS

ACCESSORIES

ALUMINUM STAIRS

BOAT LIFTS

PADDLE & LAUNCH PRODUCTS

Readily
Available for
see page 3 for details

FREE
delivery



The Dock Doctors[®] LLC

Waterfront Specialists



Vermont Sales Showroom

Take a virtual tour at:
www.thedockdoctors.com/tour



Manufacturing Facility

Factory Direct from our door to yours!

Local delivery & installation
available throughout
the Northeast

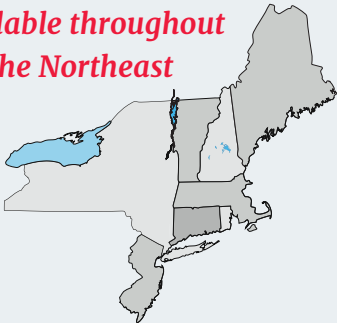

Nationwide
Shipping

800-870-6756
www.thedockdoctors.com
info@thedockdoctors.com



Warehouse & Distribution



DOCKS
STOCK DOCKS & ACCESSORIES



STAIRS
& WATERFRONT ACCESS



BOAT LIFTS
& BOAT LIFT CANOPIES



ACCESSORIES
FOR YOUR DOCKS & WATERFRONT



LAUNCH
SYSTEMS & ROWING DOCKS



DELIVERY
FREE CURBSIDE DELIVERY

TABLE OF CONTENTS

SWIM FLOATS & POND DOCKS

Stocked and available for pickup, delivery or installation

Swim Floats	4-5
Pond Docks	6-7

ALUMINUM STAIRS

Aluminum stair systems with adjustable rise and run

Adjustable Aluminum Stairs	18-19
----------------------------------	-------

STOCK DOCKS & DOCK ACCESSORIES

Stocked and available for pickup, delivery or installation

Dock Options, Accessories	8-17
Leg & Wheel Docks	20-37
Aluminum Floating Docks	38-40
Aluminum Gangways	41
Connect-A-Dock Floating Docks	42-43
Paddle & Rowing Docks.....	44-47
Connect-A-Dock Rowing Docks	48-49

DOCK & LAUNCH SYSTEMS

See full details in our Paddle Products Catalog or on our website

Launch Port Lift / Kayak Ladder Lift & Launch.....	50
Freestanding Launch.....	51

BOAT LIFTS & ACCESSORIES

Protect your boat and your dock with a boat lift

PWC & Small Craft Lifts / PWC Ports	52-53
Vertical Boat Lifts & Accessories.....	54-57
Hydraulic Boat Lifts & Accessories	58-59
Ultimate Hydraulic & Vertical Boat Lifts	60-63
Boathouse & Specialty Lifts.....	64
Custom Canopies.....	64

ORDERING INFORMATION

Site Survey / FREE ESTIMATE request	2
FREE Curbside Delivery	3
Installation & Removal Services.....	65

© Copyright 2019. Prices subject to change.



FREE Dock Design Service

Our experienced staff will create a **FREE dock layout and estimate** designed to your specific site and individual needs.

Start planning your project today!
 Complete our site survey online or call us to get started!



 **800-870-6756**

 www.thedockdoctors.com/site-survey

Browse our other catalogs

Download any of our catalogs online at: www.thedockdoctors.com/catalogs or call us at 1-800-870-6756 to have one mailed to you today.



CUSTOM CATALOG

- Custom Docks
- Marine Construction
- Custom Stairs & Waterfront Access
- Hillside Trolleys
- Commercial & Municipal Dock Systems
- Marine & Specialty Contractors
- Boat Houses



PADDLE PRODUCTS

- Storage Racks for kayaks/canoes
- Aluminum Paddlesport Trailers
- Kayak Lift & Launch
- Small Craft Dock & Launch Systems
- Paddle & Rowing Docks

FREE
delivery

Free Curbside Delivery ★★★★★



Minimum Purchase Amount <i>(not including sales tax)</i>	Free Delivery <i>from Ferrisburgh, VT</i> <i>(Distance based on Google Maps)</i>	Delivery Charge <i>one-way</i> <i>(over the free mile range)</i>
\$ 1,000	25 miles	\$2 /mile
\$ 2,000	50 miles	\$2 /mile
\$ 4,000	100 miles	\$2 /mile
\$ 6,000	150 miles	\$2 /mile
\$ 8,000	200 miles	\$2 /mile
\$10,000	250 miles	\$2 /mile



Look for the truck for our stock products that qualify for free delivery*!

*** Free Curbside Delivery Terms & Conditions:**

1. Curbside delivery definition: We will back up as close as we can with our vehicle to your installation site and off-load your product. We cannot carry your product further than the side/rear of our truck/trailer. Our delivery vehicles cannot go off of approved driveway surfaces (ie on grass, etc.).
2. Free delivery available on The Dock Doctors® Stock Products only. Please see chart to the right for minimum purchase amounts to qualify for free delivery. Free delivery does not apply to rowing or paddle docks.
3. Connect-A-Dock, Boat Lifts, canopies & accessories – free delivery applies to products in stock only.
4. If you want your product installed, please inquire on rates for this service – free delivery does not apply.
5. Additional fees apply for wide loads (assembled boat lifts) and ferry charges, if needed.
6. Purchases under \$1000 are subject to a \$2 per mile one way charge from Ferrisburgh, VT. A ground shipping method/charge by another source such as Common Carrier or UPS may be more feasible depending on product purchased.





A Aluminum Swim Float

Aluminum Swim Float

- Lightweight aluminum frame
- Optional powder coated frame
- Includes 3' aluminum ladder
- Removable decking panels



Powder Coated Swim Float & Ladder

Optional powder coating for your swim float and ladder. Available on all our swim floats (aluminum and steel). Please call for pricing and allow for additional order time.

A Aluminum Swim Float (shown above)

Ideal for use in small lakes or bays. One piece lightweight aluminum frame with polyethylene floats. Includes 3' aluminum ladder and removable decking panels.

Stock Size	Weight*	Net Buoyancy	CEDAR Price	ALUMINUM Price	WEARDECK® Price
8' x 8'	155 lbs.	960 lbs.	\$ 1,747	\$ 2,249	\$ 2,139

*Weight is with decking removed.
 Custom size swim floats available, please contact us for details. **Ipe hardwood or other composite decking options available.**



See decking details and color choices on p.13.



Now offering Connect-A-Dock Systems for Swim Floats. Please call for pricing & details.



B Galvanized Steel Swim Float

Heavy Duty Galvanized Steel Swim Float

- Two-piece galvanized steel frame
- Optional powder coated frame
- Includes 3' aluminum ladder
- Removable decking panels



Heavy duty galvanized steel swim float dismantles into two pieces for ease of handling.

B Heavy Duty Galvanized Steel Swim Float (shown above)

Ideal for rough water. Dismantles into two pieces for ease of handling. Includes 3' aluminum ladder and polyethylene floats.



Stock Size	Weight*	Net Buoyancy	CEDAR	WEARDECK®
			Price	Price
8' × 8'	226 lbs.	884 lbs.	\$ 1,829	\$ 2,219
8' × 10'	235 lbs.	850 lbs.	\$ 2,015	\$ 2,495
10' × 10'	437 lbs.	1963 lbs.	\$ 2,659	\$ 3,259



See decking details and color choices on p.13.

*Weight is with decking removed.

Custom size swim floats available, please contact us for details. **Ipe hardwood or other composite decking options available.**

Swim Float Anchors

Light Duty Swim Float Anchor Kit: \$163
includes light duty anchor block (18" × 8", 180 lbs), shackles, swivel, 3' of 3/8" chain & (2) 10' nylon ropes
Nylon extension of rope: 14' (\$10), 18' (\$13), 22' (\$16)



Heavy Duty Concrete Anchor: \$133
2' × 2' × 8", 400 lbs



Heavy Duty Float Anchor Harness: \$153
includes shackles, swivel & (2) nylon ropes

3/8" Galvanized Chain: \$4.50 per foot
(amount of chain needed is 1.5 × the water depth)



Our Pond Docks are made with a galvanized steel frame or our new 4-piece aluminum frame. Pond docks include black polyethylene floats and removable decking panels.



- **NEW** 4' × 18' (4) piece aluminum frame pond dock designed for common carrier shipping
- 4' × 16' and 4' × 20' sizes available with galvanized steel frame
- Removable decking panels
- Optional powder coated frame
- Includes (2) 3 ft. long 1 ½" pipes



A 4' × 16' Pond Dock
galvanized steel frame
*shown with optional ladder
and composite decking*

Stowe, VT

NEW **Aluminum Pond Dock** shippable to 48 U.S. States

Our new 4-piece **shippable** 4' x 18' pond dock features an aluminum frame and removable decking panels.

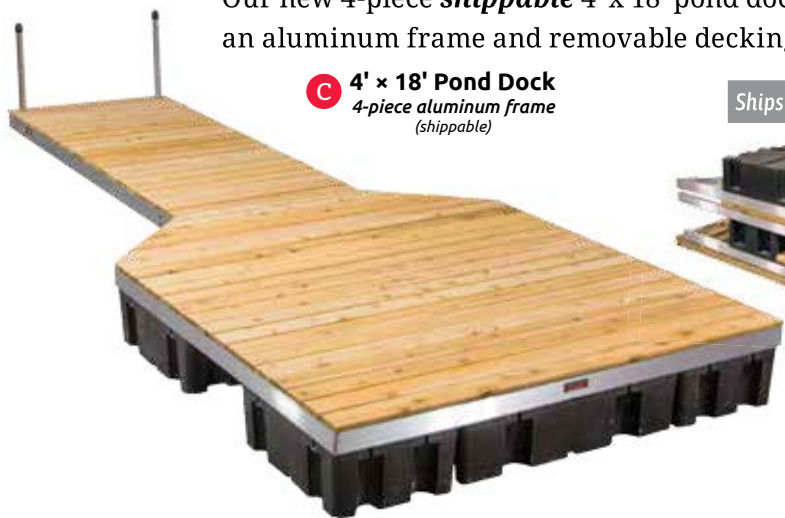

C **4' x 18' Pond Dock**
4-piece aluminum frame
(shippable)

Ships on a 4' x 10' pallet

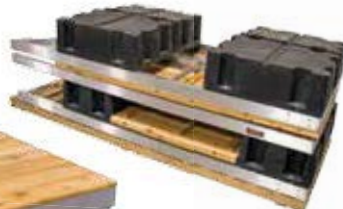

B **4' x 20' Pond Dock**
galvanized steel frame

Pond Docks

Aluminum Ladders (optional, shown on page 8)

Galvanized steel frame, or our **new** shippable aluminum frame pond docks feature removable decking panels and black polyethylene floats. Includes (2) 3 ft. long 1 1/2" pipes. *Optional powder coated frame (call for pricing).*



Stock Size	Weight*	CEDAR	WEARDECK®
		Price	Price
Galvanized Steel Frame			
A 4' x 16'	370 lbs.	\$ 2,189	\$ 2,869
B 4' x 20'	450 lbs.	\$ 2,925	\$ 3,809
Aluminum Frame (4-piece shippable)			
C 4' x 18'	360 lbs.	\$ 3,025	\$ 3,859

*Weight is with decking removed.
Ipe hardwood or other composite decking options available.

See decking details and color choices on p.13.

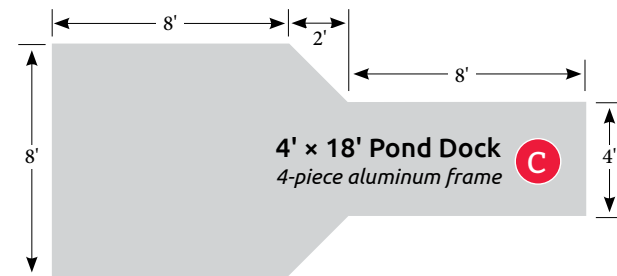
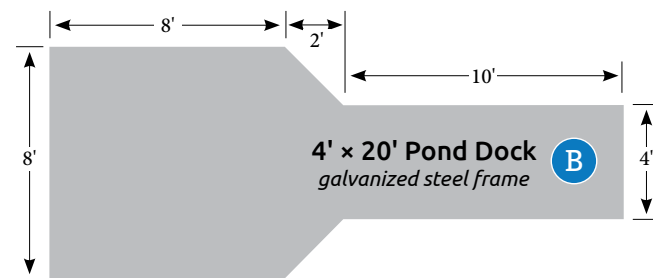
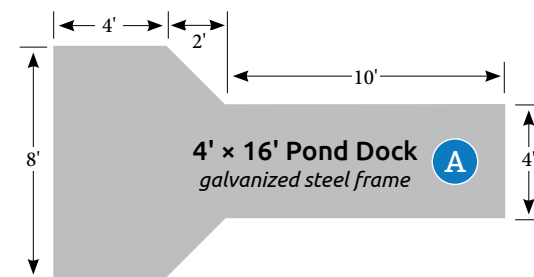



Standard Aluminum Finish

A Dock Ladders (available for all dock systems)

One-piece, removable vertical ladder with 1 ½” tubular aluminum frame and arched, slip resistant 4” treads for added comfort with bare feet.

Stock Size	ALUMINUM	POWDER COATED
3’ ladder	\$ 235	\$ 365
4’ ladder	\$ 255	\$ 390
5’ ladder	\$ 275	\$ 420

Please allow additional order time for powder coated ladders.

Dock Ladder
(powder coated finish)



Optional Powder Coated Finish (black)

Please note any dock compatibility exclusion(s) for options and accessories. Please be sure to identify your style of dock when placing orders for options.



Standard Aluminum Finish

B Shallow Water Stairs (available for all leg & wheel docks)

One-piece welded aluminum structure with aluminum handrails down each side and non-slip treads with adjustable footpads.

Stair Size	ALUMINUM	POWDER COATED	Elevation ¹
4 step	\$ 615	\$ 809	37” – 49”
5 step	\$ 665	\$ 879	45” – 57”
6 step	\$ 715	\$ 949	53” – 65”

Please allow additional order time for powder coated stairs.

¹Accommodates elevation from deck surface to lake bed.



Optional Powder Coated Finish (brown)

Lower Access Platform for swimming & kayaking

Stationary leg docks are often quite a distance above the waters' surface, making accessing the water for swimming or kayaking very difficult. Our lower access platform is designed to provide you with a safe transition to the water.

- Designed to provide lower access for swimming or using your paddle crafts
- Add our aluminum ladder (see page 8) to transition down to the platform
- 5" tall aluminum frame with Sure-Step® flow-thru, anti-slip decking
- Overall frame size: 15" wide × 9' 3" long designed to be used alongside any 8-10' long dock with 1 ½" support pipes
- Adjustable sleeves slide over 1 ½" support pipes



Lower Access Platform: **\$745**
add optional ladder (see p. 8)



Boarding Handle

Made with marine-grade aluminum, the boarding handle provides a safe handhold when boarding your boat. Mounts available for any **Dock Doctors** dock systems or universal mount to attach to any dock frame. Height from mount to top of handle is 48".

Boarding Handle **\$98**

Track Mount (shown) **\$64**

please call for pricing on other mount styles.



This product ships free within the continental USA. Visit our website for full details.

Model KDL-100



Dock Mounted Kayak Launch

For docks that are a minimal distance off the water, our dock mounted Kayak Launch (model KDL-100) has a lifting height of 30" and can accommodate crafts up to a 38" beam width. See full details in our [Paddle Products Catalog](#) or on our website.

\$1,799 SHIPS UPS



Ships FREE within the continental USA



Watch a video and find out more at: thedockdoctors.com/kayak-lift-launch



Shipping Available

Protect your boat and dock with our adjustable vertical fenders (available for all dock systems)

Our unique vertical fender design is adjustable on the mount which is often necessary due to lake level and boat style. Add a fender cleat kit (see **G** below right) for a complete securing system for your boat.



Two forms of adjustment:

- 1 Up and down on the mount and
- 2 Up and down on the pipe.

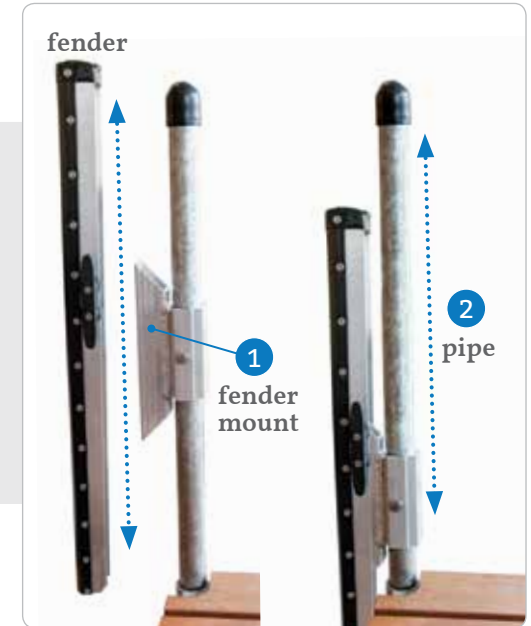

Vertical Fenders

Fender Style	Mounting Style	3' long	4' long
<i>For all Aluminum Leg & Wheel Docks & Steel Truss Leg Docks with 1 1/2" pipe:</i>			
A Fender	1 1/2" pipe mount	\$ 143	\$ 163
B Double Corner Fender	1 1/2" pipe mount	\$ 255	\$ 305
<i>For all Steel Truss Wheel Docks with 1 1/2" pipe:</i>			
C Fender with offset	1 1/2" pipe mount	\$ 153	\$ 179
<i>For all Mega Leg Docks with 3" pipe or Custom Articulating Docks with 2" pipe:</i>			
D Fender	2" or 3" pipe mount	\$ 177	\$ 199
<i>For all Aluminum "Track-Frame" Floating Docks:</i>			
E Fender (not shown)	Track Mounted	\$ 156	\$ 178
<i>For all Aluminum "Track-Frame" Floating Docks - includes spud mount:</i>			
F Fender (not shown)	Spud Anchor Mounted	\$ 338	\$ 358



Fender Cleat Kit
2 cleats included per kit

Fender Cleat Kit

Designed to be used with the 3' or 4' fenders listed to the left. Includes (2) cleats per kit that bolt onto the fender mount.

\$ 40 per kit (2 cleats)



A Edge Fender

High quality, non-marring black edge fender. Available for all aluminum “track-frame” floating docks, and custom galvanized steel floating dock systems.

\$ 7.²⁵ per foot (material only, not installed, not including fasteners)

\$ 10.⁵⁰ per foot (installed with stainless steel fasteners*)

*installation available on new dock orders only

Cleats

B Pipe Cleat (for 1 1/2" pipe)

A single cleat mounted to a sleeve that slides over the leg pipe. Available for all leg & wheel docks except the mega leg & wheel docks.

\$ 33 each

C Track Cleat

Designed to slide along the track of our floating aluminum track dock systems.

\$ 21 each

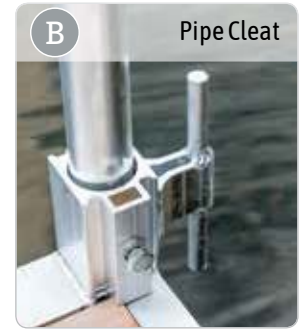

D Taylor Made Mooring Whips

Mooring whips with fixed angle base. Two-piece kit, will need to be epoxied (epoxy included with kit). Recommended for low profile boats such as bass boats, runabouts and sport boats.

MW120: **\$ 550**

MW140: **\$ 625**

(for 18' – 23' boats / 2,500–5,000 lbs.) (for 24' – 28' boats / 5,000–10,000 lbs.)

Disclaimer: Some docking conditions may be too rugged for this product.

E Mooring Whip Dock Mounts (for Dock Doctors docks)

Required for docks with removable decking. **\$ 139** for Taylor Made mooring whip models listed above only



Truss frame mount



Track frame mount



Shipping Available

A Post Covers

Post covers camouflage the 1½" leg pipe for a more rustic appearance. Available in either Cedar or optional composite material.

Style	Cedar*
Post Cover	\$ 224
Post Cover w/ 4' bumper	\$ 337
Post Cover w/ 4' bumper & cleats <i>shown with pyramid style cap with built in light</i>	\$ 385

*Includes stamped copper pyramid style cap.

B Cedar Post Cover Caps

Cast aluminum powder coated finish – available in black (optional other colors available).

Composite covers available - please inquire for pricing.

Style	Black
B1 Pyramid Style Cap	\$ 60
B2 Pyramid Style Cap <i>with built in 110 volt light and ribbed glass</i>	\$ 119
B3 Flat Top Style Cap (not shown) <i>with built in 110 volt light and ribbed glass</i>	\$ 119

Cedar Post Cover



shown with (B1) pyramid style cap

Cedar Post Cover with 4' bumper & cleat



shown with (B2) pyramid style cap with light

Composite Post Cover



B1 pyramid style cap



B2 pyramid style cap with built in 110v light



*Note: Light kits do not include wiring. Both 12 volt & 110 volt are available.



skirt boards

Skirt boards for our galvanized steel truss dock systems provide the aesthetic appearance of a wooden dock.

C Skirt Boards

Used to camouflage the truss frame to give the appearance of a wooden dock system. *Please inquire for further details.*

D Flag Poles

Add beauty to your waterfront property with a telescoping flagpole. These poles have no ropes, chains or pulleys so you do not have to worry about knots and tangles and they are virtually noise-free.



Each section of the pole raises and lowers easily. 16' tall telescoping aluminum flagpole includes a 3" gold aluminum ball ornament, a double flag harness to fly two flags or fly at half mast, a 3' x 5' nylon USA flag with embroidered stars and sewn stripes. Other pole heights available as special order.

Flag Poles

Style	Suggested Retail	Our Price
D1 Silver Finish Flag Pole	\$ 339	\$ 289
D2 Black Finish Flag Pole	\$ 369	\$ 309
Dock Mounts		Price
D3 Deck surface mount		\$ 80
D4 Side mount		\$ 80
D5 Pole mount for docks with 1 ½" leg pipe		\$ 80

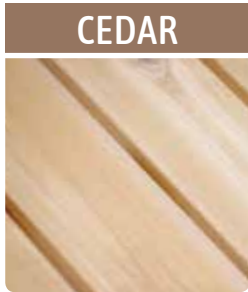

CEDAR

CEDAR is a natural, cost effective decking option that is naturally resistant to decay and insects. Red cedar will weather to a soft, silvery gray. *Cons:* Over time will absorb moisture and weather unless sealed with a preserving stain.



ALUMINUM

ALUMINUM resists the growth of mold and mildew and won't rust, rot, split or stain. The powder-coated finish eliminates glare from the aluminum. The non-slip, rigid, surface is low-maintenance and cool to the touch. *Cons:* Can sound metallic when walking on it, especially on our docks with removable panels.



SURE-STEP®

SURE-STEP is a slip-resistant, polypropylene surface that allows water and sunlight through to help conserve the underwater ecosystem. Preferred option for dock structures that are situated close to the water so waves will pass through the decking, adding minimal resistance. *(Available on our aluminum docks and swim floats).* *Cons:* Only available in certain dimensions, so may not be a viable option for many applications.

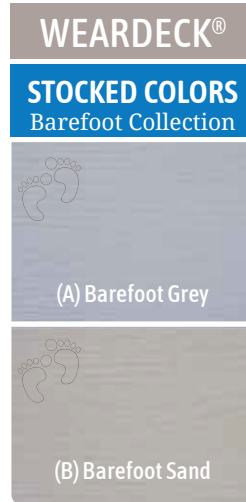

WEARDECK®

STOCKED COLORS
Barefoot Collection

(A) Barefoot Grey

(B) Barefoot Sand



WEARDECK®

SPECIAL ORDER COLORS*

(C) Weatherwood

(F) Saddle

(D) White

(G) Gray

(E) Cedar

(H) Sand

**please inquire for pricing and lead times.*



IPE

WEARDECK is a high density polyethylene resin with UV inhibitors. Weardeck's 5/4" thick deck board is rated to span joists 24" on center with the highest live load capacity in the industry. Rated for ground and underwater contact and will not support mold or mildew growth. This product is 100% manufactured in Ocala, FL and offers a 25 year commercial and a lifetime residential warranty. *Cons:* Not a natural wood.



Barefoot Collection

"Lighter Colors, Cooler Touch"



Heat-Reflective Technology

- Reflects the sun's hot rays off the surface of the board
- Reduces surface temperature by at least 30% on each color

IPE is extremely hard, very durable and naturally resistant to rot and insects. Ipe's strong, resilient properties make it an excellent material choice for marine applications. *Cons:* It is a natural wood, therefore there will be inconsistencies with regard to color, weathering and texture. Due to the density of Ipe, it is heavy and hard to drill and cut, therefore more labor intensive than working with other decking materials.



A Dock Mounted Roller

A single 12" keel roller designed to assist you when moving canoes, kayaks, or other small crafts on or off the dock. **\$ 112**



universal mount
mounts to dock
frame or decking



track frame mount
for aluminum floating
docks shown on p. 38-40



B Single Craft Storage Arms (dock mounted)

A pair of small craft storage arms featuring vinyl hull guards, and end caps with built in tie-down openings. Available in Universal Pipe Mount (fits all docks with 1 1/2" pipe).

\$ 169 STANDARD ALUMINUM

\$ 199 POWDER COATED BLACK



C 2-Craft Storage Rack (dock mounted)

Our dock mounted small-craft storage racks mount to the frame of your dock to store kayaks, canoes, paddle boards, and other small crafts.

\$ 506 STANDARD ALUMINUM

\$ 669 POWDER COATED BLACK

Note: Fits Dock Doctors Steel Truss & Aluminum Track floating dock systems, as well as a Universal Mount for wood dock systems.

Please identify what style of dock this will be mounting to when ordering.



D 6-Craft Freestanding Storage Rack

Marine-grade aluminum frame freestanding storage rack with adjustable height arms. Arms feature vinyl hull guards and end caps with built in tie-down openings. Available in aluminum or powder-coated black finish.

\$ 899 STANDARD ALUMINUM

\$ 1199 POWDER COATED BLACK

See more styles in our
Paddle Products catalog
or on our website

www.thedockdoctors.com/paddle-products



Commercial
Storage Rack

Aluminum Storage Racks



E 3-Craft Freestanding Storage Rack

Same features as our 6-craft rack on page 14, in a single-sided design. Available in aluminum or powder-coated black finish.

\$ 674 STANDARD ALUMINUM

\$ 909 POWDER COATED BLACK

Freestanding Storage Rack: *optional accessories*



F Adjustable Feet

Ideal for uneven ground (includes 2 feet, mounting brackets and hardware).

\$159 STANDARD ALUMINUM

\$187 POWDER COATED BLACK



G Additional Support Arms

Includes 2 arms, mounting brackets and hardware.

\$108 STANDARD ALUMINUM

\$139 POWDER COATED BLACK



H Wall Mounted Storage Rack

Marine-grade aluminum frame wall-mounted storage rack with adjustable height arms. Arms feature vinyl hull guards and end caps with built in tie-down openings. Available in aluminum or powder-coated black finish. Optional additional arms (see G at bottom left).

\$ 499 STANDARD ALUMINUM

\$ 695 POWDER COATED BLACK



Wall-mounted rack mounted horizontally with additional arms added for multiple board storage.



All our products are proudly made in the USA



Shipping Available



Easy Hassle Free Mounting
No Wiring Required



\$ 55.95
package of 2

Solar Dock Post Lites

- Fits standard pipes (1 1/2" & 2" ID in size)
- 6" H x 3.5" diameter (UV stabilized polycarbonate)
- (1) Super bright LED (12 Lumens)
- Automatic night activation
- Fully sealed electronic circuit board
- Powerful solar panel
- Lasts 18+ hours on a full charge
- Replaceable 1.2v NiMH battery
- Two (2) post lites in each package



1 3/8" Dock Dots

The smallest solar lights you have ever seen! Easy to install in minutes with a quick 1 3/8" drill bit or hole saw.

Available with white LEDs only **\$ 55.95**
package of 4

Deck Lights

Industrial strength solar powered dock light made from marine grade anodized aluminum for superior protection in harsh marine environments.

Available with white LEDs only **\$ 34.95**
each



Sea Gull Eliminators

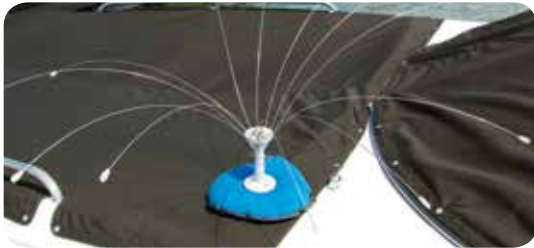

Bird-B-Gone® Bird Spider 360°

The Bird-B-Gone's spider's spinning motion is effective at deterring birds from landing on your boat, swim raft or dock. Stainless steel arms with scuff-preventing polycarbonate tips move with the breeze. Mount permanently (screws included) or use an optional rail, bimini or sandbag mount.

Model #MMBS400SPN (4' diameter) **\$ 49.99**

Model #MMBS800SPN (8' diameter) **\$ 59.99**



Bird-B-Gone® 360° Repellent

6' diameter, wind driven rotator keeps birds from roosting on your boat, swim raft or dock. Includes standard mounting block (screws included). Optional rail, bimini or portable sandbag mounts sold separately.

Model #MMRPL360 **\$ 49.99**



Sandbag Base

Attaches directly to either style repeller and comes with all the necessary hardware. Has eyelets around outer ring for extra security. Weighs 8 lbs.

Model #MMBSBB-SB **\$ 41.99**



Rail Mount

For mounting to boat railing 1" to 1.86" in size and other surfaces that will accept a C-clamp.

Model #MMRLMNT **\$ 22.99**
sale price



Boat Base

Used to secure either style bird repellents to masts, spreaders and other areas. Comes with all the necessary hardware.

Model #MMBSBB2 **\$ 9.99**
sale price

Dock Adjustment & Installation Tools

Adjustment Kit

Adjust the level of your dock with this kit that slides over the 1 ½" leg pipe. Available for all leg & wheel docks with 1 ½" pipe. Sold as a pair (winch with sleeve and hook).

\$ 260 / pair



Spud Puller & Pounder Kit

This (2) piece system aids in the installation and removal of spud pole anchors for our floating dock systems.

2" puller/pounder kit: \$ 265

3" puller/pounder kit: \$ 333

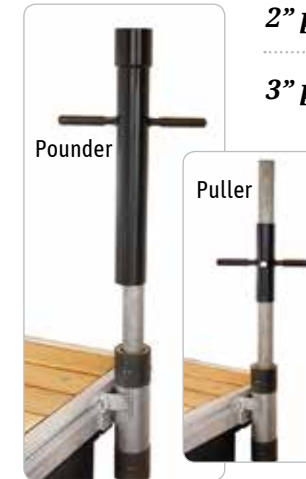

Boat Lift Installation & Removal Tools

Make the seasonal installation and removal of your boat lift easier with a wheel kit and/or air bag lift system.

A Boat Lift Wheel Kits

Specifically designed for use with RGC® boat lifts and can be modified for use with hydraulic boat lifts. Includes a pair of welded galvanized steel mounting brackets and (2) heavy duty polyethylene wheels.

BLW2045 (fits 2,000 - 4,500 lb. lifts): **\$ 315 / pair**

BLW5060 (fits 5,000 - 6,000 lb. lifts): **\$ 329 / pair**



B Air Bag Lift Kits

Inflatable 250 and 500 lb. capacity air bags with attachment strap to float your boat lift for seasonal installation and removal. Ideal when used in conjunction with a wheel kit (see photo on left). Includes connecting kit (carabiner and strap).

250 lb. capacity: \$ 260

500 lb. capacity: \$ 380



3' x 4' stair platforms incorporated into a long run of stairs.

Our lightweight **aluminum portable stairs** are rigid and adjustable, with features designed to accommodate a variety of waterfront applications. Offering a lifetime of virtually maintenance free features, these quality aluminum stairs are an economical solution for waterfront access and ideal for replacing your old wooden steps.

Aluminum Stair Features

- Readily available in lengths up to 18'
- Adjustable rise & run (27 to 44 degrees) to accommodate your site
- Custom fabrication available for specific applications & lengths
- Marine grade aluminum extrusions with stainless steel fasteners
- Lightweight & easy to carry for a two-person installation
- Non-skid, 28" wide stair treads
- Rounded aluminum handrails on both sides
- Optional adjustable footpads for base of stairs
- Includes mounting bracket
(designed for easy seasonal installation & removal of stairs)



Non-skid, 28" wide stair treads



Aluminum Stairs

All stairs are 28" wide

All stairs can be assembled to fit any distance between the minimum and maximum rise.

# of Steps	Price*	Minimum Rise @ 6" (27°)	Run with 6" rise	Length with 6" rise	Maximum Rise @ 9" (44°)	Run with 9" rise	Length with 9" rise	Weight
4	\$ 732	2' 0"	4' 7"	5' 0"	3' 0"	3' 11"	4' 11"	65 lbs.
6	\$ 1,020	3' 0"	6' 6"	7' 2"	4' 6"	5' 6"	7' 1"	93 lbs.
8	\$ 1,215	4' 0"	8' 5"	9' 4"	6' 0"	7' 1"	9' 3"	115 lbs.
10	\$ 1,450	5' 0"	10' 4"	11' 6"	7' 6"	8' 8"	11' 5"	142 lbs.
12	\$ 1,709	6' 0"	12' 3"	13' 8"	9' 0"	10' 2"	13' 7"	164 lbs.
14	\$ 1,929	7' 0"	14' 2"	15' 10"	10' 6"	11' 9"	15' 9"	173 lbs.
16	\$ 2,199	8' 0"	16' 1"	18' 0"	12' 0"	13' 3"	17' 11"	188 lbs.
n/a	\$ 589	3' x 4' stair platform (standard duty aluminum with aluminum decking)						32 lbs.

*Price includes mounting bracket (fasteners to existing platform not included); handrails down each side and slip resistant stair treads. Stair uprights remain vertical in any rise. Optional top and/or bottom stair platform in 3' x 4' standard duty aluminum. Optional pair of Adjustable Footpads includes brackets to mount to bottom of stairs, 1 1/2" aluminum support pipes 24" long, black safety caps & aluminum footpads. Requires stair frame drilling on-site to mount.

Assembly Options: *Unassembled:* Requiring assembly on site to contour to desired rise (note: some drilling is required).

Pre-assembled: Factory assembled and adjusted to desired rise (note: additional assembly charge will apply).

*Prices do not include shipping/delivery – please call for pricing.



mounting bracket



rounded aluminum handrail



(optional)

Adjustable Footpad

\$194 / pair

Requires drilling stair on-site to mount.

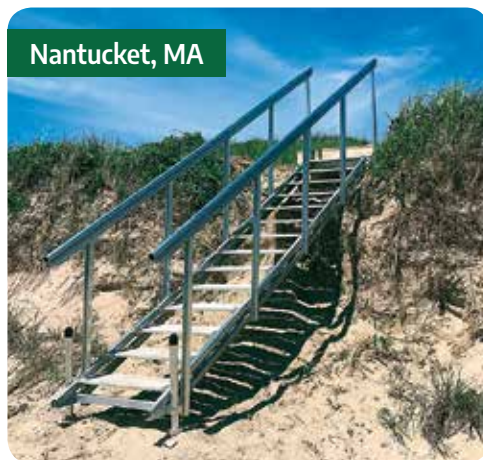

Nantucket, MA





Designed for smaller lakes and bays, our standard duty aluminum frame leg and wheel docks feature an exceptionally strong aluminum frame. Strong yet lightweight, these docks can be installed by one person.

Salisbury, VT

Standard Duty Aluminum Leg & Wheel Docks

- Exceptionally strong aluminum frame
- Support stanchions built into the frame for an obstruction-free dock edge
- Removable decking in cedar, composite – or attached Sure-Step® decking
- Ipe hardwood decking option also available



Fill out our site survey and we will send you a free estimate and conceptual layout customized to your property.
www.thedockdoctors.com/site-survey

 Watch a video and find out more at: thedockdoctors.com/launch-port



Standard duty aluminum leg dock with Sure-Step® decking, 2-craft storage rack (see page 14) and our freestanding launch port system.



EASY one person install

Our innovative connector clips and lightweight sections allow for one person to easily connect sections together and install the dock system.



Brookfield, VT

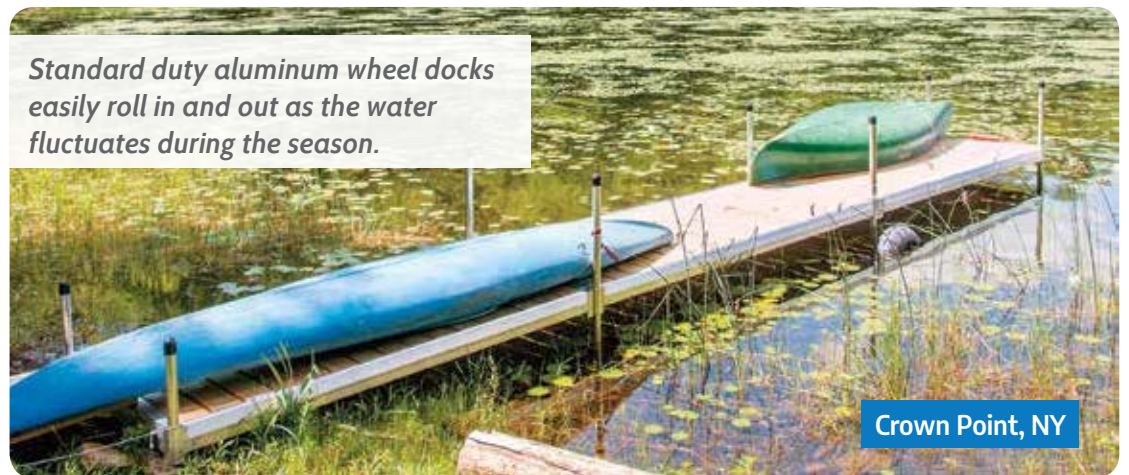

Standard duty aluminum wheel docks easily roll in and out as the water fluctuates during the season.

Crown Point, NY

Assembly Components

Connector Clips
for connecting
docks together
\$ 25 set of 2



Safety Cap
for 1 1/2" pipe
\$ 5.50 each



**Aluminum
Pipe 1 1/2"**
cut to length
pending
water depth
\$ 6.95 per foot



**Footpad
(aluminum)**
\$ 35 each



Cross Braces
(optional)
stabilizes docks in
deeper water
\$ 149



4' x 8' Leg Dock



4' x 12' Wheel Dock



Standard Duty Aluminum: Leg & Wheel Docks

Size	Weight*	CEDAR	ALUMINUM	WEARDECK®	SURE-STEP®
		Price	Price	Price	Price
LEG DOCKS					
4' x 8'	49 lbs.	\$ 588	\$ 839	\$ 809	n/a
4' x 10'	63 lbs.	\$ 674	\$ 985	\$ 945	n/a
4'3" x 8'5"	99 lbs.	n/a	n/a	n/a	\$ 785
4'3" x 10'5"	125 lbs.	n/a	n/a	n/a	\$ 899
WHEEL DOCKS					
4' x 12'	95 lbs.	\$ 1,134	\$ 1,509	\$ 1,459	n/a
4'3" x 12'5"	149 lbs.	n/a	n/a	n/a	\$ 1,405

See decking details and color choices on p.13.

Dock pricing includes frame and removable decking. Wheel dock pricing includes (1) pair of wheels and axle assembly. The necessary assembly components are sold separately.

*Weights for docks do not include the decking with the exception of docks with Sure-Step® decking, which attaches directly to the dock frame and is not removable.



Caspian Lake,
Greensboro, VT

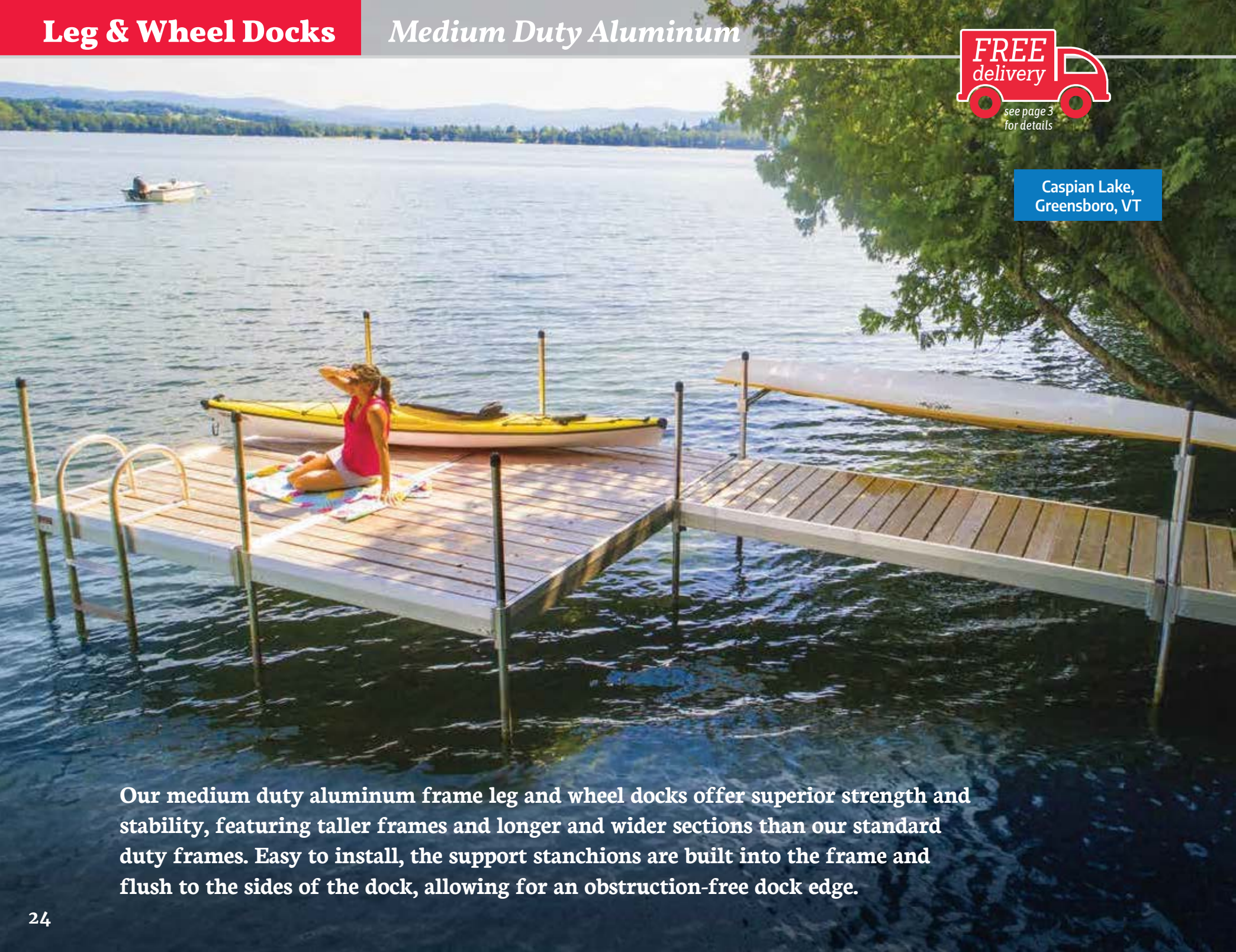

Our medium duty aluminum frame leg and wheel docks offer superior strength and stability, featuring taller frames and longer and wider sections than our standard duty frames. Easy to install, the support stanchions are built into the frame and flush to the sides of the dock, allowing for an obstruction-free dock edge.

Medium Duty Aluminum Leg & Wheel Docks

- Exceptionally strong, 7" tall aluminum frame
- Support stanchions built into the frame, for an obstruction-free dock edge
- Removable decking panels in cedar, composite or aluminum
- Ipe hardwood decking option also available



EASY to install

No sharp edges on underside of frames make our aluminum docks easy on the hands for carrying.



West Glover, VT

Above Top: Medium duty aluminum docks with cedar decking and 2,000 lb. vertical boat lift. Inset: Dock sections installed side-by-side to create an "L" shape with optional triangle section for more deck space.



Orwell, VT

Made in

the **USA**



Lake Bomoseen, Castleton, VT



Medium duty aluminum leg docks with aluminum decking. Accessed by our adjustable aluminum stairs (see pages 18-19).



Ausable Forks, NY

Medium duty aluminum leg docks with NyloDeck® decking and single craft storage arms (see page 14).



Medium duty aluminum docks used to create a shoreside deck area.

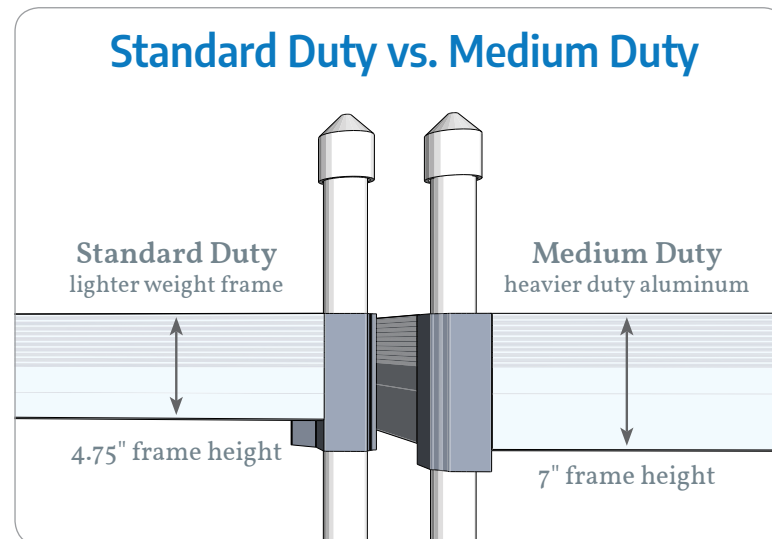

Medium duty aluminum leg docks with NyloDeck® decking at a town beach in Washington, NH.

Assembly Components

Connector Clips
for connecting
docks together
\$ 35 set of 2



Safety Cap
for 1 1/2" pipe
\$ 5.50 each



**Aluminum
Pipe 1 1/2"**
cut to length
pending
water depth
\$ 6.95 per foot



Footpad
(aluminum)
\$ 35 each



Cross Braces
(optional)
stabilizes docks in
deeper water
\$ 149 (4' wide docks)
\$ 159 (6' wide docks)



6' x 8' Leg Dock



4' x 16' Wheel Dock

Medium Duty Aluminum: Leg & Wheel Docks

Size	Weight*	CEDAR	ALUMINUM	WEARDECK®
		Price	Price	Price
LEG DOCKS				
4' x 8'	71 lbs.	\$ 749	\$ 999	\$ 969
4' x 10'	85 lbs.	\$ 859	\$ 1,169	\$ 1,129
4' x 12'	100 lbs.	\$ 955	\$ 1,339	\$ 1,279
6' x 8'	89 lbs.	\$ 969	\$ 1,329	\$ 1,259
6' x 10'	107 lbs.	\$ 1,115	\$ 1,565	\$ 1,469
6' x 12'	125 lbs.	\$ 1,249	\$ 1,789	\$ 1,669
3' x 3' triangle corner	30 lbs.	\$ 429	\$ 475	\$ 465
WHEEL DOCKS				
4' x 16'	129 lbs.	\$ 1,690	\$ 2,190	\$ 2,115
6' x 16'	161 lbs.	\$ 1,915	\$ 2,639	\$ 2,469

See decking details and color choices on p.13.

*Dock pricing includes frame and removable decking. Wheel dock pricing includes (1) pair of wheels and axle assembly. The necessary assembly components are sold separately. *Weights for docks do not include the decking. Ipe hardwood or other composite decking also available as a special order.*

Leg & Wheel Docks

Heavy Duty Steel Truss



Designed for exposed sites and rough water conditions, our heavy duty steel truss leg and wheel docks are incomparable for strength and durability. The heavy duty truss frame allows water to pass through the frame.



Ticonderoga, NY

Heavy Duty Steel Truss Leg & Wheel Docks

- Designed for exposed sites
- Heavy duty 9" galvanized steel truss frame with adjustable leg stanchions built into frame
- Removable decking in cedar or composite
- Ipe hardwood decking option also available
- 10 year limited warranty



Transition safely with our ladders, shallow water stairs, or stair systems.

(A&B shown on page 8, C shown on pages 18-19)



Above: Steel truss leg docks with dock-mounted 2-craft storage rack.



Above: Steel truss leg docks with cedar decking, vertical fenders, solar post lights and shallow water stairs (see accessories on page 8-17).



Peacham, VT



6' wide leg docks with IPE decking upgrade and our lower access platform – for swimming and boarding paddle crafts (see page 9).

Assembly Components

Connecting Brackets

each connection requires (4)

End-to-end: \$ 13.⁵⁰/ea

Side-by-side: \$ 13.⁵⁰/ea

Catwalk (3"): \$ 11.⁵⁰/ea

catwalk requires (2)
3" brackets & (2) truss
end-to-end brackets



Safety Cap

for 1 1/2" pipe

\$ 5.⁵⁰ each

Galvanized Pipe 1 1/2"

cut to length

pending water depth

\$ 6.⁹⁵ per foot



Footpad

(galvanized steel)

\$ 37 each



Dock Panel Securing Cord

\$ 5.²⁵ set of 4



Cross Braces

(optional)

stabilizes docks in
deeper water

\$ 149 (4' wide docks)

\$ 159 (6' wide docks)



4' x 10' Leg Dock



4' x 16' Wheel Dock



Heavy Duty Steel Truss: Leg & Wheel Docks

Size	Weight*	CEDAR	WEARDECK®
		Price	Price
LEG DOCKS			
4' x 8'	100 lbs.	\$ 858	\$ 1,079
4' x 10'	115 lbs.	\$ 919	\$ 1,189
6' x 8'	125 lbs.	\$ 1,110	\$ 1,399
6' x 10'	150 lbs.	\$ 1,175	\$ 1,529
2' x 10' catwalk (std duty)	75 lbs.	\$ 489	\$ 629
3' x 3' triangle corner	45 lbs.	\$ 302	\$ 349
WHEEL DOCKS			
4' x 16'	208 lbs.	\$ 1,825	\$ 2,249
6' x 16'	230 lbs.	\$ 2,065	\$ 2,619
4' x 16' with 4' x 8' L	328 lbs.	\$ 2,694	\$ 3,319
6' x 16' with 4' x 8' L	350 lbs.	\$ 2,935	\$ 3,669



IPE

Ipe hardwood & other composite decking
also available as a special order.



See decking details and color choices on p.13.

Dock pricing includes frame and removable decking. Wheel dock pricing includes (1) pair of wheels and axle assembly. The necessary assembly components are sold separately. *Weights for docks do not include the decking.



Designed for use in rough and deep water applications, our mega duty steel truss leg and wheel docks feature taller frames, longer and wider sections, and larger diameter upright supports than our heavy duty steel truss dock systems. Available in two stock sizes (or contact us for custom size dock options).

Shelburne, VT

Mega Duty Steel Truss Leg & Wheel Docks

- Designed for use in rough & deep water applications
- 11" tall galvanized steel truss frame
- 3" diameter upright supports
- Stocked in 6' × 20' & 8' × 20' sizes (custom sizes available)
- Adjustable leg stanchions built into frame
- Removable decking in cedar or composite
- Ipe hardwood decking option also available



Above: 6' wide mega duty leg dock with aluminum gangway (see page 41).





Shelburne, VT

Sliding Boarding Step \$899
Bridges the gap from your dock to your boat



Remove the gap to transition safely to/from your boat. Securely attaches to your existing dock. Find out more at: www.thedockdoctors.com/boardingstep



Shelburne, VT

Heavy Duty vs. Mega Duty Frames

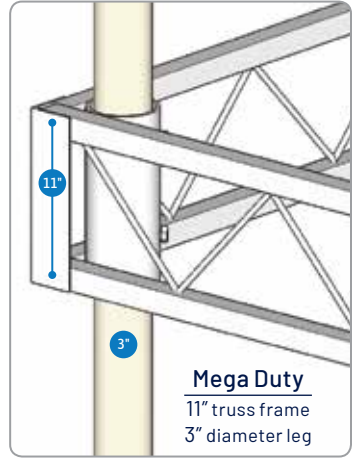
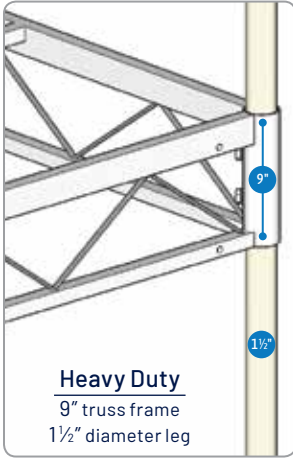

Our mega dock used as shoreside access to a custom floating dock (see our **Custom Catalog**).

Assembly Components

Connecting Brackets
each connection requires (4)
\$ 25.⁵⁰ each



Safety Cap
for 3" pipe
\$ 6.⁹⁵ each



Galvanized Pipe 3"
cut to length pending water depth
\$ 12.⁹⁵ per foot



Footpad
(galvanized steel)
\$ 50 each

Dock Panel Securing Cord
\$ 5.²⁵ set of 4



Cross Braces
(not shown, optional stabilizes docks in deeper water)

\$ 179 (6' wide docks)

\$ 189 (8' wide docks)



Mega Dock Adjustment Kit

adjust the level of your dock with this kit that slides over the 3" leg pipe

\$ 449 pair



6' x 20' Mega Duty Leg Dock

Mega Duty Steel Truss: Leg & Wheel Docks



Stock Size	Weight*	CEDAR Price	WEARDECK® Price
LEG DOCKS			
6' x 20'	400 lbs.	\$ 3,569	\$ 4,269
8' x 20'	480 lbs.	\$ 4,769	\$ 5,749
WHEEL KITS			
for 6' wide docks	\$ 449		
for 8' wide docks	\$ 469		



Ipe hardwood decking also available as a special order.

Pricing includes dock frame and removable decking. Custom sizes available as a special order. The necessary assembly components are sold separately. *Weights do not include the decking.

See decking details and color choices on p.13.



Our medium duty aluminum floating docks feature our "aluminum track" frame - allowing for easy mounting of hardware and accessories. These pre-manufactured "stock" docks are readily available for pick up, delivery or installation and are designed to be easily installed for the do-it-yourselfer.



Plymouth, VT

Above: Medium duty aluminum floating docks with aluminum decking, optional edge fender and anchored with our spud pole anchor mount.



Medium Duty Aluminum Floating Docks

- Used in residential & light commercial applications
- Exclusively designed frame by The Dock Doctors®
- Universal track-style 5" tall aluminum frame allows for easy mounting of hardware & accessories
- Removable decking in cedar, aluminum or composite
- Ipe hardwood decking also available
- Foam filled, black polyethylene flotation



Medium duty aluminum floating dock and aluminum gangway.



Medium duty aluminum floating docks with optional powder coated frame upgrade and solar post lites (see p. 16).

Our heavy duty aluminum docks are ideal for sites with more exposure (see pages 4-5 & 53-55 in our Custom Catalog).





4' x 12' Medium Duty Aluminum Floating Dock



Medium Duty Aluminum: Floating Docks

Size	Weight*	CEDAR	ALUMINUM	WEARDECK®
		Price	Price	Price
FLOATING DOCKS				
4' x 12'	225 lbs.	\$ 1,499	\$ 1,875	\$ 1,825
4' x 16'	260 lbs.	\$ 1,880	\$ 2,379	\$ 2,299
6' x 12'	270 lbs.	\$ 2,025	\$ 2,565	\$ 2,445
6' x 16'	350 lbs.	\$ 2,535	\$ 3,259	\$ 3,089
8' x 12'	410 lbs.	\$ 2,495	\$ 3,215	\$ 3,075
8' x 16'	483 lbs.	\$ 3,085	\$ 4,039	\$ 3,849

See decking details and color choices on p.13.



Powder Coated Frame Upgrade
please call for pricing



Pricing includes frame, decking and flotation. Anchoring, connecting hardware and shore mount sold separately. Note: Docks used as a shore ramp may require adjustable float frame and shore connection pending layout. Ipe hardwood decking option available. *Weights do not include the decking.

Assembly Components

Hinge Connector Kits

Hinge connector kits include bushing, stainless steel pins, wear and dampener system and protective cap (cap not shown).



\$ 168
(for 4' wide docks)

\$ 174
(for 6' wide docks)

\$ 180
(for 8' wide docks)



Anchor Mounts:
Spud Pole \$ 225
pipe sold separately

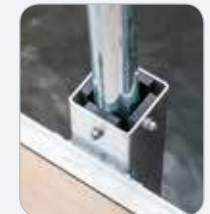

Chain Tube \$ 118
chain for anchoring
sold separately





Aluminum gangway as a transition to our Aluminum Floating Docks (above).



Aluminum gangway as a transition to our Mega-Duty Leg Docks (see on pages 34-37).



(2) 80' gangways during manufacturing.



Commercial gangways available with minimal time frames in any length/width

Aluminum Gangways

see decking details on p.13

Size	Weight*	CEDAR Price	ALUMINUM Price
RESIDENTIAL 3' x 24'	295 lbs.	\$3,179	\$3,745
COMMERCIAL custom size and length with minimal time frame		please call	please call

*Weights listed do not include the decking.

Pricing for all gangways includes decking and handrails. Commercial quality gangways are readily available in any length and with other types of decking. Hinge connections and shore mounts sold separately.

Connect-A-Dock floating docks accommodate a variety of uses with many modular sizes and freeboard heights.



Waterville Valley, NH

photo courtesy of Waterville Valley Recreation Department

Above: "1000 Series" lower profile system with Dock Doctors floating dock as a ramp and shore hitch.



- Wood grain anti-skid surface
- Ultra tough, polyethylene construction
- 1000 Series provides 8" of freeboard
- 2000 Series provides 17" of freeboard



Above: "2000 Series" higher profile system at a state park.



Shown connected to 2000 series floating dock section.
 Outside Dimensions: 48" wide x 60" long x 22" high.
 Inside Dimensions: 34" wide x 17" high.
 Accommodates crafts up to 34" wide. Weight: 99 lbs.

YAKPORT®

The YAKport launch makes getting in and out of the water easy for beginners or experienced users. The YAKport can be installed to virtually any floating or fixed dock and can be used for kayaks, canoes or stand up paddle boards (SUP) up to 34" wide. Made from highly durable UV protected polyethylene. **YAKport: \$620 MSRP**

Dock Connection Kits:

- Fixed Docks: **\$166**
- 1000 Series: **\$120**
- 2000 Series: **\$189**

Optional items:

- Overhead assist bars: **\$154**
- Yak "grab" bars (long): **\$194 each**
- Yak "grab" bars (short): **\$108 each**

additional anchoring may be required



1000 series float section



1000 series corner



2000 series used as a Sea Plane dock.



1000 series dock and swim float.



Quantity Discounts Available

Connect-A-Dock: Floating Docks

Below is a list and pricing of the most popular sizes - please call or write for a complete list of all Connect-A-Dock® product, anchoring and accessories available.

Series	Model	Size	Price Ea
1000	FS1030	45" × 30" Float Section	\$ 341
1000	FS1060	45" × 60" Float Section	\$ 680
1000	FS1120	90" × 120" Float Section	\$ 2,106
1000	CFS1010	44" × 33" Corner	\$ 277
1000	FC1020	Float Connector (1000 series)	\$ 47
2000	FS2120	72" × 120" Float Section	\$ 2,106
2000	FS2096	48" × 96" Float Section	\$ 1,264
2000	CFS2022	48" × 67" Corner	\$ 453
2000	FC2020	Float Connector (2000 series)	\$ 83



2000 series float section



2000 series corner

Our aluminum-frame paddle docks feature heavy-duty aluminum frames suitable for commercial or residential applications. Their modular design allow for a variety of layout options.



Heavy Duty Aluminum Paddle Docks

- 7" Aluminum Track Frame with 10"-12" freeboard (approximate — pending sections, size & decking choices)
- Heavy duty, stainless-steel connection hinges
- Optional powder coated frame
- Cedar decking, or upgrade to optional Ipe or composite
- Foam filled black polyethylene floats
- Optional marine-grade black vinyl edge fender
- Optional debris diverter protects the dock from floating debris often seen in river settings



Optional angled ladder



Spud pole anchor example

Paddle Docks

Heavy Duty Aluminum

Standard Size

Price

8' x 20' *as low as* **\$5,579**

10' x 20' *as low as* **\$6,819**

8' x 16' ramp section *as low as* **\$4,259**

Custom sizes and wider ramps available. Standard pricing includes aluminum frame, cedar decking and flotation. Site conditions, exposure, anchoring details and ramp requirements to be determined for final pricing.

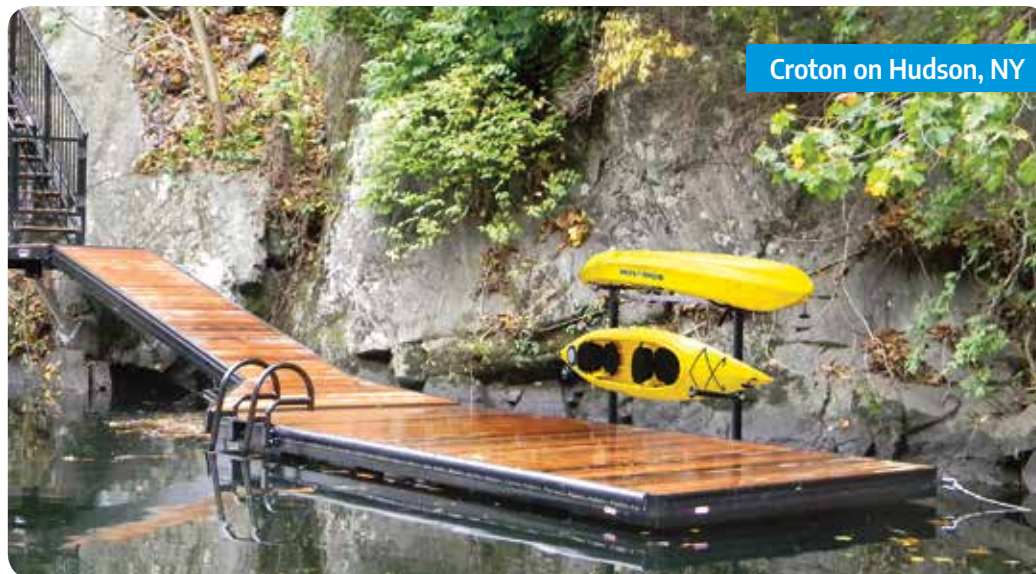

Croton on Hudson, NY

Powder coated heavy duty aluminum paddling dock with dock mounted kayak rack.



Mirror Lake, Lake Placid, NY

Paddle dock shown with composite decking & powder coated finish.



Our heavy-duty, aluminum-frame rowing docks feature a modular design for a variety of layout options. Designed for commercial or residential applications.



City of Dover, NH

Our aluminum frame Rowing Dock with 38' x 7' aluminum gangway with commercial kayak launch with ADA transfer platform. Our pile dock serves as a shore hitch (see our [Custom Catalog](#), pp 16-17).

- 7" Aluminum Track Frame with 6"- 8" freeboard
- Heavy duty, stainless-steel connection hinges
- Modular track-style frame allows easy additions of optional components and multiple layout options
- Foam filled black polyethylene floats
- Cedar decking, or upgrade to optional Ipe or Composite
- Optional marine grade black vinyl edge fender
- Optional debris diverter protects the dock from floating debris often seen in river settings



Fish Creek, Saratoga, NY

Heavy duty aluminum frame rowing docks with composite decking.



Rondout Rowing Club
Kingston, NY



YMCA Camp Coniston
Croydon, NH

Rowing Docks

Heavy Duty Aluminum

Standard Size	Price
8' x 20'	as low as \$5,579
10' x 20'	as low as \$6,819
8' x 16' ramp section	as low as \$4,259
8' x 20' flared ramp section	as low as \$5,679

Custom sizes and wider ramps available. Standard pricing includes aluminum frame, cedar decking and flotation. Site conditions, exposure, anchoring details and ramp requirements to be determined for final pricing.

Accessories & Options	Price
A Wheel Kit	\$849 / set
B Angled Dock Ladder (aluminum)	\$398
<i>Items not shown:</i>	
Debris diverter - 8' long	as low as \$2,790
Debris diverter - 10' long	as low as \$3,485
Hinge connections	as low as \$342
Edge Fender (black vinyl, installed on dock)	\$10.⁵⁰ / lineal foot



Axle & Wheel mounts for seasonal installation & removal.



Angled ladder (aluminum).

The Dock Doctors are the exclusive distributors of *Connect-A-Dock* products for New England and New York. Please contact us for pricing and details.



Applications ideal for Connect-A-Dock products:

- Rowing / Sculling docks
- Small craft access for canoes & kayaks
- Floating dock slip in calm bodies of water
- Walkway in marsh wetlands



Versatile modular floating dock system by Connect-A-Dock.



Connect-A-Dock benefits:

- Modular design
- Easy to install
- UV protected
- Environmentally friendly
- Does not contain CCA
- Salt water safe
- 8 year product warranty



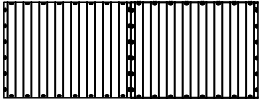
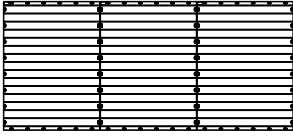

Rowing Docks

Standard Size	Price
7'6" × 20" 1000 Series Rowing System 	starting at \$4,494* (including connectors)
10' × 22'6" 1000 Series Rowing System 	starting at \$7,070* (including connectors)

Quantity Discounts Available

*Sample pricing does not include any anchoring, ramp to shore, etc. Please call for a free estimate.

Our innovative **Kayak Launch Systems** provide a smooth transition for you and your paddle craft to and from the water. Please visit our website at: www.thedockdoctors.com/paddleproducts or refer to our **Paddle Products Catalog** for full details and pricing.



This product ships free within the continental USA. See our website for details.

FREE
shipping



Launch Port Lift

ideal for fluctuating water

If your water levels fluctuate, our launch port lift raises and lowers 5 ½ feet (66.5") so you to easily get your kayak, canoe or other small craft into the water. Non-skid Sure-Step® vinyl decking on the platform and 30" handwheel that raises and lowers the platform.

 Watch a video and find out more at: thedockdoctors.com/launch-port-lift

Kayak Lift & Launch *mounts to seawalls or permanent docks*

Launch your kayak from your seawall or permanent dock with our innovative Kayak Lift & Launch. The platform features Sure-Step® vinyl decking and raises and lowers up to 5 ½ feet so you can safely and easily launch your kayak or other craft. Includes boarding handle, paddle storage hooks and kayak leash to secure your craft.

 Watch a video and find out more at: thedockdoctors.com/kayak-lift-launch



▶ Watch a video and find out more at: thedockdoctors.com/launch-port

Freestanding Launch Port System

- Ideal for controlled bodies of water with minimal fluctuation
- Non-marring Stoltz® rollers
- Optional grab and launch rails offer more control for gliding on and off the launch platform
- See our [Paddle Products](#) catalog or visit our website for more details: www.thedockdoctors.com/launch-port



Easy-access boarding handle



Grab and launch rails

Commercial Launch Systems

See pages 51 in our CUSTOM catalog or visit our website for more details on our commercial launch systems.



Floating Kayak Launch (shown left)

Can be used as a complete floating dock system, integrated into existing systems, or in conjunction with any of our floating dock systems.

Floating "add-on" Kayak Launch (shown right)

Ideal to add onto existing municipal or commercial floating dock systems.



▶ Watch a video and find out more at: thedockdoctors.com/commercial-launch



PWC & Small Craft Lifts

- 1,000 lb. & 1,200 lb. capacity cantilever models
- Stainless steel hardware & cables
- Polymer pulley sheaves prolong cable life
- Dual mounting winch (left or right side)
- 15 Year Limited Warranty
- 1,250 lb. vertical & 2,000 lb. hydraulic models also available
(see Vertical Lift section on p. 55 or Hydraulic Lift section on p. 58)
- Manufactured by RGC



Model Capacity	PL1000 1,000 lbs	PL1200 1,200 lbs	PL1200W 1,200 lbs
Max. Beam	64"	70"	87"
Lifting Height	46"	46"	46"
Bed Length	72"	96"	96"
Min. Water Depth	9"	10"	10"
Overall Width	72"	80"	98"
Adjustable Legs	(4) @ 18"	(4) @ 18"	(4) @ 18"
Shipping Weight	155 lbs	257 lbs	316 lbs
MSRP	\$ 1,620	\$ 2,225	\$ 2,725
Sale Price <i>(assembled)</i>	\$ 1,575	\$ 2,115	\$ 2,565
Sale Price <i>(unassembled)</i>	\$ 1,460	\$ 1,999	\$ 2,450

Safe harbor for your personal watercraft!

The **Connect-A-Port 2XL by Connect-A-Dock®** with universal hull support makes docking personal watercraft safe and easy! Simply idle up and drive on to dock and roll-off to launch.



Connect-A-Port Options

- Attachment kit for fixed & floating docks
- Connecting hardware to link multiple units (side by side)
- Bow stop winch (to help secure your PWC in rougher water conditions)

Find out more online at:

www.thedockdoctors.com/pwc-port

The Dock Doctors are the exclusive distributors of **Connect-A-Dock products** for New England and New York. Please contact us for pricing and details.



Model: CAPO002

157" × 58.5" × 23"

(398.8 cm × 148.6 cm × 58.4 cm)

Maximum flotation: 1700 lbs. (771 kg)

Weight: 340 lbs. (154.2 kg)

Price: \$ 1,924* MSRP: \$ 2,138

**Price does not include attachment or connecting hardware to dock system.*

Dock Connection Kits:

Connect-A-Dock kit: **\$239**

Fixed dock kit: **\$139**

Floating dock kit: **\$137**

Connecting multiple units:

Side-by-side kit: **\$76**

Connect-A-Port Features & Benefits

- Accommodates 1, 2, 3 and 4-place personal watercrafts
- Ultra tough, polyethylene construction
- Two keel rollers
- Four or six bow rollers
- Patented bow stop
- Cable & clip for securing PWC
- Multiple, molded-in tie down loops or handles
- Anti-skid walk area
- Universal hull support
- Front or side mounting
- 5-Year product warranty

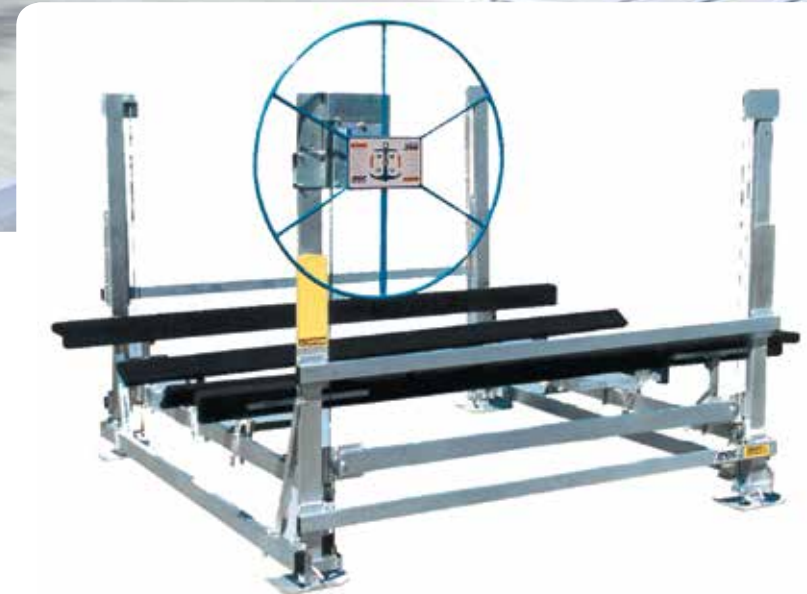

Aluminum Vertical Boat Lifts

- All stainless steel hardware & cables
- High lifting range
- Minimal water required
- Manufactured by RGC
- 15 year limited warranty
- Delivery & installation available

Aluminum Vertical Boat Lifts

Model #	Weight Capacity	Max. Beam	Overall Width	Overall Length	Lifting Height	Min. Water	Shipping Weight	MSRP Price	Dock Doctors Price (assembled)	Dock Doctors Price (unassembled)
VL1250*	1,250 lbs	65"	73"	82"	75"	8.5"	233 lbs	\$ 2,700	\$ 2,650	\$ 2,430
VL20100*	2,000 lbs	100"	108"	100"	66"	9.5"	249 lbs	\$ 3,550	\$ 3,525	\$ 3,195
VL35108	3,500 lbs	108"	116"	108"	68"	8"	495 lbs	\$ 5,370	\$ 5,165	\$ 4,725
VL35116 T	3,500 lbs	116"	124"	108"	80"	8"	520 lbs	\$ 5,830	\$ 5,570	\$ 5,130
VL45108	4,500 lbs	108"	116"	116"	68"	8"	507 lbs	\$ 5,660	\$ 5,420	\$ 4,980
VL45116	4,500 lbs	116"	124"	116"	68"	8"	510 lbs	\$ 5,830	\$ 5,570	\$ 5,130
VL45116 T	4,500 lbs	116"	124"	116"	80"	8"	523 lbs	\$ 6,115	\$ 5,638	\$ 5,198
VL40124 P**	4,000 lbs	124"	132"	141"	68"	8"	445 lbs	\$ 6,010	\$ 5,839	\$ 5,289
VL50124 T	5,000 lbs	124"	133"	132"	80"	9"	597 lbs	\$ 6,620	\$ 6,265	\$ 5,825
VL60124 T	6,000 lbs	124"	133"	132"	80"	9"	663 lbs	\$ 6,930	\$ 6,390	\$ 5,890
VL70132 TP**	7,000 lbs	132"	141"	138"	78"	11"	800 lbs	\$ 9,760	\$ 8,925	\$ 8,295
VL80124 T***	8,000 lbs	124"	133"	132"	78"	11"	777 lbs	\$ 10,550	\$ 9,570	\$ 8,965
VL100132***	10,000 lbs	132"	147"	158"	78"	13"	1217 lbs	\$ 16,745	\$ 14,998	\$ 14,230

All pricing is F.O.B. our facility in Ferrisburgh, VT. Prices are for in stock product only. Additional freight charges may apply for special orders. Boat lift prices include (4) adjustable 29" legs with footpads and carpeted pressure treated bunks. Manual handwheel is included with non-electric models. *Lift includes 18" legs. **Bunks not included with pontoon lift - add desired kit from kits listed at bottom of page. †***Lifts include AC Direct Drive with remote control and double carpeted wood bunks. 7k Pontoon lift includes AC Direct Drive w/remote control. † Measured from top of load tubes to bottom of feet when adjustable legs are fully retracted. Measurements are approximate.

Pontoon & Tritoon Cradle Kits

Lift Model	Pontoon Cradle & Guide Kit	Tritoon Cradle & Guide Kit	Pontoon Deck Kit
4000-4500	\$ 965	\$ 1,245	\$ 625
5000	\$ 1,065	\$ 1,385	\$ 645
6000	\$ 1,170	\$ 1,510	\$ 645
7000	\$ 1,215	\$ 1,560	n/a

Pontoon Cradle & Guide Kit

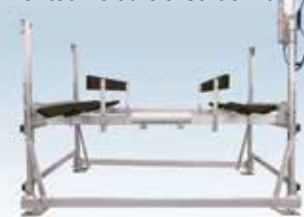

Pontoon Deck Kit



Pontoon and Tritoon cradle kits available

A Vertical Lift Guides, Motor Stops & Extension Legs

Lift Models	Carpeted Guides		Other Options		
	regular adjusts from 16"-25 1/2" high	tall adjusts from 25"-34 1/2" high	3" Vinyl Motor Stop	Ext. Legs 4' pair	Ext. Legs 6' pair
3500	\$ 625	\$ 640	\$ 165	\$ 255	\$ 320
4500	\$ 625	\$ 640	\$ 165	\$ 255	\$ 320
5000	\$ 665	\$ 675	\$ 165	\$ 255	\$ 320
6000	\$ 665	\$ 675	\$ 195	\$ 255	\$ 320
8000	n/a	\$ 705	\$ 195	\$ 255	\$ 320
10,000	n/a	\$1,035*	\$ 195	\$ 330	\$ 370

*Tall guides for 10,000 lb. boat lift adjust 25" - 43 1/2". Credits available with the purchase of a new boat lift: Credit \$95 for a pair of 29" legs if upgrading to longer extension legs with the purchase of a new boat lift.

Electric Drive Units

Lift Models	AC Drive Systems				DC Drive Systems			
	Direct	Direct with remote	Extreme Max Manual	Extreme Max with remote	Direct	Direct with remote	Extreme Max Manual	Extreme Max with remote
3500	\$ 1,775	\$ 2,580	\$ 1,070	\$ 1,520	\$ 2,460	\$ 2,735	\$ 1,070	\$ 1,520
4500-5000	\$ 1,820	\$ 2,690	\$ 1,070	\$ 1,520	\$ 2,460	\$ 2,735	\$ 1,070	\$ 1,520
6000	\$ 1,790	\$ 2,690	\$ 1,070	\$ 1,520	\$ 2,380	\$ 2,750	\$ 1,070	\$ 1,520

Note: Drives listed are for lifts with R18 winches only. Please inquire for pricing and information on electric drives for D&L winches. Credit \$175 for handwheel with the purchase of a direct drive and a new boat lift.

- B Direct Drive** This direct drive uses an industrial oil bath gear reducer and motor with a stainless steel cover which connects to the standard winch. Available with a remote control option. Available as an AC or DC unit.
- C Extreme Max Drive System** Manual key or optional remote control operation with a backup bit for manual operation of the unit in the event of a power outage. Comes complete with mounting kit.
- D VL Solar Power Box** Portable solar power source for waterfront owners with no electricity. Lightweight white fiberglass box holds (2) deep cycle batteries with a power source on/off switch. Available as solar or with an A/C trickle charger. **Solar charged: \$ 1,319 A/C charged: \$ 1,269**

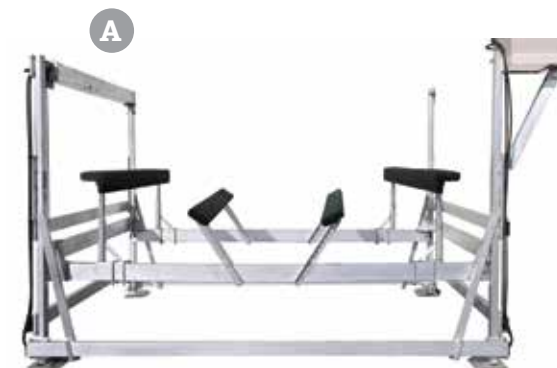

Shown with optional carpeted guides



Direct A/C drive with manual switch



Extreme Max D/C drive with remote control and solar power box.



Above: "Cadet Grey" canopy.
Left: "Pacific Blue" canopy.



Optional straight edge canopy canvas now available / please call or email for pricing

Sunbrella® Boat Lift Canopies

Lift Models	Description	(unassembled) Price
20100	18' × 100"	\$ 2,820
20100	21' × 100"	\$ 3,140
35108/45108	21' × 108"	\$ 3,315
35108/45108	24' × 108"	\$ 3,450
45116	24' × 116"	\$ 3,550
45116	26' × 116"	\$ 3,740
45116	28' × 116"	\$ 4,125
45116	30' × 116"	\$ 4,295
40124/50124/60124/80124	24' × 124"	\$ 3,670
40124/50124/60124/80124	26' × 124"	\$ 3,855
40124/50124/60124/80124	28' × 124"	\$ 4,190
40124/50124/60124/80124	30' × 124"	\$ 4,305
100132	32' × 132"	\$ 4,680
100132	36' × 132"	\$ 5,110

Prices include aluminum canopy frame & fabric in standard colors:

■ Pacific Blue ■ Cadet Grey ■ Forest Green ■ Heather Beige ■ Slate

Signature colors available as a special order at an additional cost. Additional costs for shipping may apply for canopies not in stock.

Boat Lift Installation & Removal Tools

Make the seasonal installation and removal of your boat lift easier with a wheel kit and/or air bag lift system.

A Boat Lift Wheel Kits

Specifically designed for use with RGC® boat lifts and can be modified for use with hydraulic boat lifts. Includes a pair of welded galvanized steel mounting brackets and (2) heavy duty polyethylene wheels.

BLW2045 (fits 2,000 - 4,500 lb. lifts): **\$ 315** / pair

BLW5060 (fits 5,000 - 6,000 lb. lifts): **\$ 329** / pair



B Air Bag Lift Kits

Inflatable 250 and 500 lb. capacity air bags with attachment strap to float your boat lift for seasonal installation and removal. Ideal when used in conjunction with a wheel kit (see photo on left). Includes connecting kit (carabiner and strap).

250 lb. capacity: **\$ 260**

500 lb. capacity: **\$ 380**



- Available from 2,000 to 12,000 lb. capacity
- Stainless steel hardware
- Aluminum hydraulic cylinders
- Full length vinyl bunks
- Pontoon & Tritoon kits available
- Solar or AC charging options
- Manufactured by RGC
- 15 year limited warranty



Hydraulic Aluminum Lifts

Model #	Weight Capacity	Max. Beam	Lifting Height	Min. Bunk Height	Shipping Weight	Lifting Speed UP (seconds)	Lifting Speed DOWN	Hydraulic Cylinders	MSRP	(assembled) Dock Doctors Price	(unassembled) Dock Doctors Price
HL20065	2,000 lbs.	65"	48"	24"	235 lbs.	30 sec	20 sec	1	\$ 6,132	\$ 5,795	\$ 5,520
HL40120XL	4,000 lbs.	120"	60"	26"	542 lbs.	65 sec	45 sec	2	\$ 9,262	\$ 8,610	\$ 8,335
HL50120XL	5,000 lbs.	120"	60"	28.5"	680 lbs.	45 sec	45 sec	2	\$ 10,062	\$ 9,130	\$ 8,855
HL70120XL	7,000 lbs.	120"	60"	30"	760 lbs.	90 sec	50 sec	2	\$ 11,242	\$ 10,065	\$ 9,890
HL90120XL	9,000 lbs.	120"	60"	31"	997 lbs.	110 sec	75 sec	4	\$ 15,359	\$ 13,175	\$ 12,900
HL120132XL	12,000 lbs.	132"	60"	40"	1,500 lbs.	80 sec	90 sec	4	\$ 21,529	\$ 18,400	\$ 17,990

*Prices above include (4) 3' legs, battery, AC charger & remote control. For solar power upgrade add \$120 or \$150 for 9k & 12k models. All pricing is F.O.B. our facility in Ferrisburgh, Vermont. Prices are for in stock product only. Additional freight charges may apply for special orders. See page 3 for delivery information.

† Measured from top of bunks to bottom of feet when adjustable legs are fully retracted. Measurements are approximate.

Pontoon and Tritoon kits available for Hydraulic Lifts – contact us for options and pricing.

Hydraulic Lift Accessories

Stainless Steel Fitting Upgrades

Cylinders & Hose Assemblies

Lift Model	Upgrade when purchasing new boat lift	Stainless Steel Extension Hoses	
		12'	20'
HL 1.75K – 2K	\$ 305	\$ 450	\$ 510
HL 4K – 6K	\$ 735	\$ 450	\$ 510
HL 7K	\$ 805	\$ 450	\$ 510
HL 9K	\$ 1,960	\$ 450	\$ 510
HL 12K	\$ 3,820	\$ 450	\$ 510

Elevated Power Box Stand

This stand provides protection for your power box from heavy wave action or high water. Aluminum frame provides 15" of height above the deck surface. **\$ 250**
Power box not included in price.



HL Boat Lift Accessories: Guides, Extension Hoses and Extension Legs

Lift Model	Aluminum & Wood Guides	Aluminum Rollers* (for guides)	Standard Ext. Hose 4½' pair	Standard Ext. Hose 12' pair	Standard Ext. Hose 20' pair	Ext. Legs 5' pair	Ext. Legs 7' pair w/ bracing	Ext. Legs 9' pair w/ bracing
3000–4000	\$ 1,210	\$ 120	standard	\$ 185	\$ 240	\$ 265	\$ 845	\$ 985
5000–7000	\$ 1,255	\$ 120	\$ 130	\$ 185	\$ 240	\$ 265	\$ 845	\$ 985
9000	\$ 1,295	\$ 120	\$ 130	\$ 185	\$ 240	\$ 265	\$ 845	\$ 985
12,000	\$ 3,090^	\$ 120	\$ 130	\$ 185	\$ 240	\$ 265	\$ 995	\$ 1,120

* The aluminum rollers are a recommended option for the aluminum guides. Credit \$160 for 3' legs if upgrading to longer extension legs with the purchase of a new boat lift.
^Guides for 12K lift model are available in aluminum and vinyl only.



Optional straight edge canopy canvas now available / please call or email for pricing

HL Canopies

Size	Price
24' x 124" Canopy	\$ 3,670
26' x 124" Canopy	\$ 3,855
28' x 124" Canopy	\$ 4,190

Note: Prices include standard color Sunbrella® Fabric (Pacific Blue, Cadet Grey, Forest Green, Heather Beige & Slate).
Optional and signature colors are available as a special order (additional cost).



Canopy Leg Kits

Size	Price
4' Canopy Leg Kit with 8' posts	\$ 1,020
6' Canopy Leg Kit with 8' posts	\$ 1,170
8' Canopy Leg Kit with 8' posts	\$ 1,410

All pricing is F.O.B. our facility in Ferrisburgh, VT. Prices are for in stock product only. Additional freight charges may apply for special orders.

The design features of this **Ultimate Hydraulic Boat Lift** offers enhanced quality in the areas that have proven not to be reliable to our standards within other top hydraulic lift brands over the years.

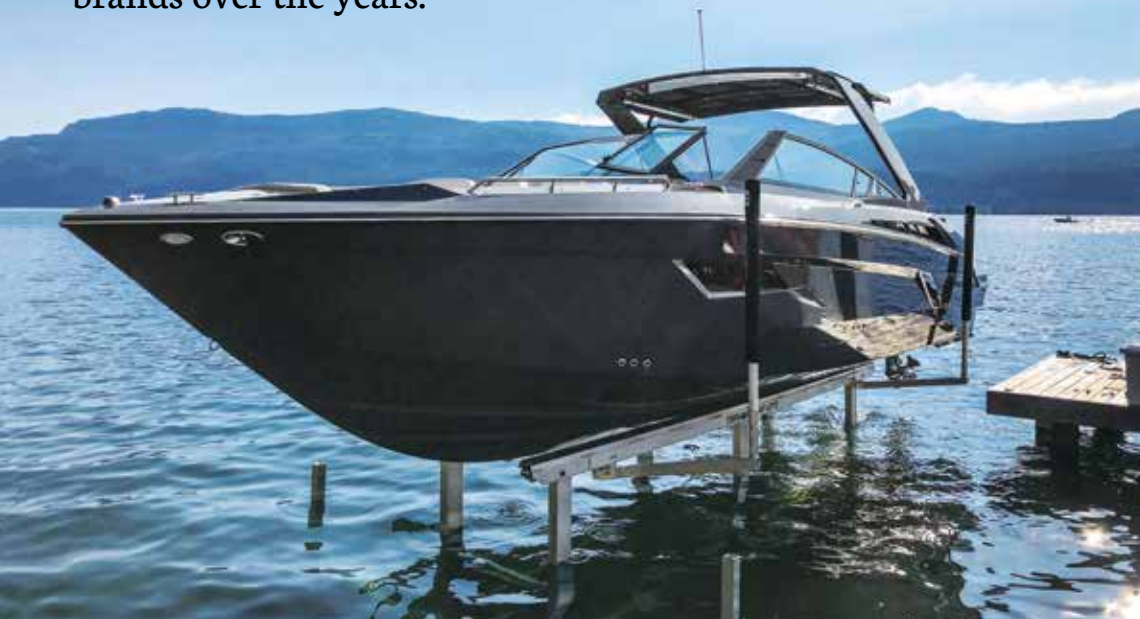

Ultimate Hydraulic Boat Lift Features

- Heavy duty hydraulic pump with stainless steel housing
- Larger Structural Components than All Others to Prevent Flex & Wear
- Hydraulic Cylinder Shafts are Protected from Marine Growth with the Exclusive Air Bellows
- Exclusive Multi Bunk for use for V-Hull, Step Hull, Pontoon & Deck Boats
- Waterproof Remote Transmitter & Receiver
- Stainless Steel Hoses are Standard-Not an Option like Other Manufacturers
- Manufactured with T-6 Marine Grade Aluminum & Stainless Hardware

NEW PRODUCT
*Aluminum hydraulic boatlifts
up to 32,000 lb capacity*

- All Materials & Components are Made in The USA
- Lift Capacities ranging from 3k through 32k
- Ideal for Both Freshwater & Saltwater Environments
- Highest Lift Travel with 6.5' of Rise
- Manufactured by Golden Boatlifts



Ultimate Vertical Boat Lift – by *The Dock Doctors*

- Vertical lifts from 6,000 lb. to 32,000 lb. capacity
- 9 ft. standard lift height (other heights available)
- Great for shallow or deep water applications
- Adaptable to boathouses for use with permanent docks
- High lift for rough water & fluctuating water levels
- Portable/seasonal if necessary
12,000 lb. & larger models fabricated in modular sections for ease of seasonal handling
- Industrial quality hot dipped galvanized steel construction, stainless steel cables & galvanized fasteners
- Custom heights, widths & lengths are available to accommodate your boat & location



Above: 32,000 lb. capacity Ultimate Boatlift.

Right: Modular section of the boatlift shown above, being loaded for delivery.



Ideal for boats from 6,000 to 32,000 lbs, our **Ultimate Vertical Boat Lifts** are custom manufactured with industrial quality hot-dipped galvanized steel. This lift can be used in shallow and deep water applications, rough water, and in fluctuating water levels. The 12,000 lb. and larger models are modular for ease of seasonal handling.



9,000 lb. Ultimate Vertical Lift, Shelburne, VT

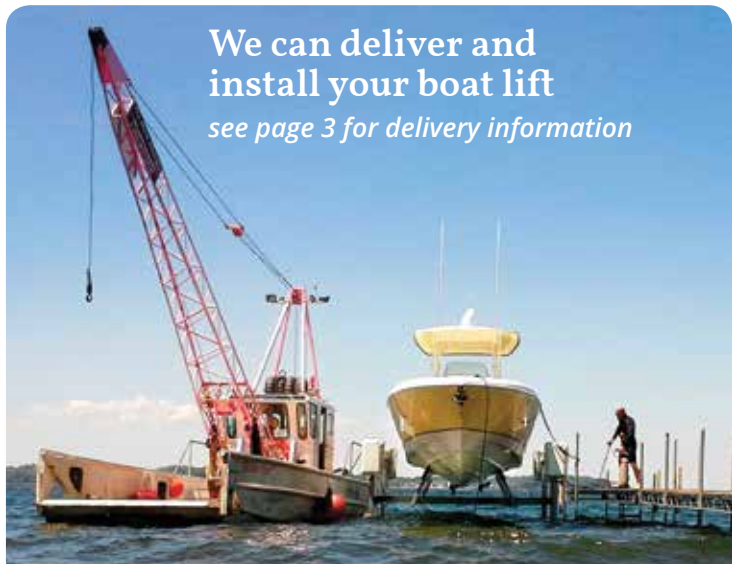

Diamond Point, NY

12,000 lb. capacity Ultimate Lift

Dock Doctors® Ultimate Vertical Boat Lifts



Model #	Capacity	# of Drives	Maximum Beam	Lifting Height	Overall Width	Overall Length	Price*
6000	6,000 lbs.	2	8' 6"	9'	11'	12'	\$ 13,800
9000	9,000 lbs.	2	10'	9'	12'	13'	\$ 15,560
12000	12,000 lbs.	4	11'	9'	13'	14'	\$ 23,090
18000	18,000 lbs.	4	12'	9'	14'	16'	\$ 26,735
24000	24,000 lbs.	4	14'	9'	16'	18'	\$ 31,675
32000	32,000 lbs.	4	18'	9'	20'	20'	\$ 36,395
Auto Stop System (recommended option)							\$ 955

Custom sizes are available.

*Prices above include Gem remote control, sealed bearing and grooved cable winders, AC drives, (4) 7' vertical guide poles with PVC sleeves, (4) wheel mounts, (4) 24" adjustable legs and heavy duty carpeted bunks. Optional oil bath drives and full length guide-ons are available. Please inquire for pricing.

Sliding Boarding Step \$899

Bridges the gap from your dock to your boat



Remove the gap to transition safely to/from your boat. Securely attaches to your existing dock. Find out more at: www.thedockdoctors.com/boardingstep



Queensbury, NY

12,000 lb. capacity Ultimate Lift with oil bath drive upgrade.



Shelburne, VT

12,000 lb. Ultimate vertical boat lift with custom canopy.

Boathouse Lifts are custom built to be installed in new or existing boathouses. These lifts are designed to accommodate various boat styles, capacities, and in some cases, aesthetic appearance.

- Freestanding units for boathouses without structural integrity to support your boat
- Bunk style cradle system with pull-out tubes for winter storage
- Sling style for shallow water applications

See pages 28–29 in our *CUSTOM* catalog or visit our website for more details on our Custom Boat Lifts.



Occasionally, protecting your boat requires a product that is designed to fit your individual needs. We can design, fabricate, and install custom canopies, boat lifts and much more to accommodate unique situations. Please contact us for a free estimate and conceptual layout.



Above: The Dock Doctors Ultimate Lift (see pages 60–63) customized to attach to the shore with galvanized lift arms which allow it to be raised for winter storage.



Lake Placid, NY

Custom powder coated uprights for use with a standard RGC® canopy.

Installation & Removal Service - Let the Waterfront Specialists do it for you!

Living in the Northeast often has the added responsibility of removing and installing your dock system every year. Take the worry and hassle away with **The Dock Doctors® seasonal service plan**, and have the assurance that your system will be taken care of with the utmost quality and safety in mind.

We provide service to all areas in the Northeast



Our portable workboats from 25'-32' in length allow us to provide installation for our products throughout the Northeast.





Visit our showrooms

Vermont Showroom & Manufacturing Facility Take a virtual tour at: www.thedockdoctors.com/tour



Vermont Showroom & Manufacturing Facility

19 Little Otter Lane, Route 7, Ferrisburgh, VT 05456

 **800-870-6756**

 **info@thedockdoctors.com**

Monday–Friday 9:00–4:30

Saturday 9:00–1:00 (April 6th thru July 27th)

Showroom closed Memorial Day Weekend and 4th of July

*Open
year-round!*



Lake Placid/Saranac Showroom

876 State Route 86, Ray Brook, NY

 **800-870-6756**

 **info@thedockdoctors.com**

Seasonal Hours (May 31st through September 6th)

Tuesday–Friday 10am–4:30pm Saturday 10am–2pm

Showroom closed Memorial Day Weekend and 4th of July



2019 STOCK CATALOG