

The Dock Doctors[®] LLC

Waterfront Specialists

2018 Stock Catalog



Made in



USA

Readily Available for

FREE
delivery

see page 3
for details



Docks

Accessories

Aluminum Stairs

Boat Lifts

Paddle & Launch Products

The Dock Doctors[®] LLC

Waterfront Specialists



Vermont Showroom & Manufacturing Facility

Start planning your waterfront project today!

Factory Direct... From Our Door to Yours!

**Local delivery & installation
available throughout
the Northeast**

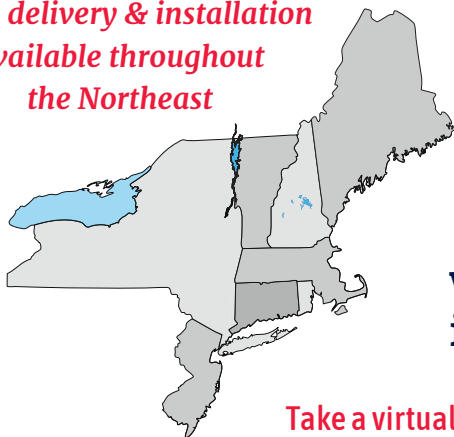

**Nationwide
Shipping**

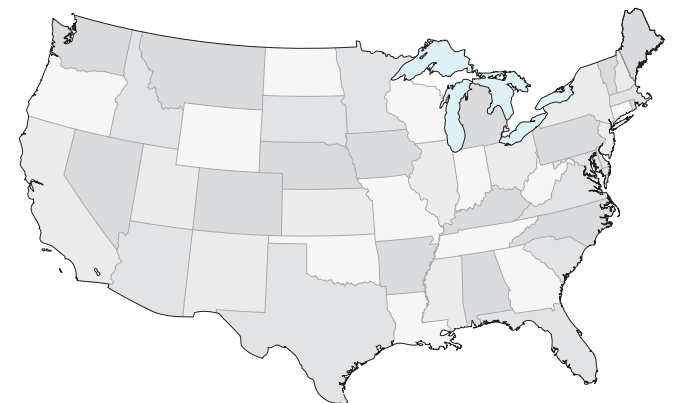

800-870-6756
www.thedockdoctors.com
info@thedockdoctors.com

Take a virtual tour of our facility at: www.thedockdoctors.com/tour



DOCKS
STOCK DOCKS & ACCESSORIES



STAIRS
& WATERFRONT ACCESS

TABLE OF CONTENTS

SWIM FLOATS, POND DOCKS & ACCESSORIES
Stocked and available for pickup, delivery or installation

Swim Floats 4-5
Pond Docks 6-7
Dock Options, Accessories 8-17

ALUMINUM STAIRS
Aluminum stair systems with adjustable rise and run

Adjustable Aluminum Stairs 18-19

STOCK DOCKS
Stocked and available for pickup, delivery or installation

Leg & Wheel Docks 20-37
Aluminum Floating Docks 38-40
Aluminum Gangways 41
Paddle & Rowing Docks 42-45
Connect-A-Dock Products 46-47

DOCK & LAUNCH / PADDLE & ROWING DOCKS
Launch systems and rowing docks

Kayak Ladder Lift & Launch 48-49
Launch Port Lift / Freestanding Launch 50-51

BOAT LIFTS & ACCESSORIES
Protect your boat and your dock with a boat lift

PWC & Small Craft Lifts / PWC Ports 52-53
Vertical Boat Lifts & Accessories 54-57
Hydraulic Boat Lifts & Accessories 58-59
Ultimate Vertical & Hydraulic Boat Lifts 60-63
Boathouse & Specialty Lifts 64
Custom Canopies 64

ORDERING INFORMATION

Site Survey / FREE ESTIMATE request 2
FREE Curbside Delivery 3
Installation & Removal Services 65

© Copyright 2018. Prices subject to change.



BOATLIFTS
& BOAT LIFT CANOPIES



ACCESSORIES
FOR YOUR DOCKS & WATERFRONT



LAUNCH
SYSTEMS & ROWING DOCKS



DELIVERY
FREE CURBSIDE DELIVERY



FREE Dock Design Service

Let us assist you with creating the ideal dock and waterfront system! Our experienced staff will create a **FREE dock layout and estimate** designed to your individual needs and specific site conditions!

Start planning your project today!
 Call us or complete our site survey online to get started!

800-870-6756

www.thedockdoctors.com/site-survey



Browse our other catalogs

Download any of our catalogs online at: www.thedockdoctors.com/catalogs or call us at 1-800-870-6756 to have one mailed to you today.



CUSTOM CATALOG

- Custom Docks
- Marine Construction
- Custom Stairs & Waterfront Access
- Hillside Trolleys
- Commercial & Municipal Dock Systems
- Marine & Specialty Contractors
- Boat Houses



PADDLE PRODUCTS

- Storage Racks for kayaks/canoes
- Aluminum Paddlesport Trailers
- Kayak Lift & Launch
- Small Craft Dock & Launch Systems
- Paddle & Rowing Docks

Free Curbside Delivery ★★★★★



* Free Curbside Delivery Terms & Conditions:

Look for the truck for our stock products that qualify for free delivery*!

1. Curbside delivery definition: We will back up as close as we can with our vehicle to your installation site and off-load your product. We cannot carry your product further than the side/rear of our truck/trailer.
2. Free delivery available on The Dock Doctors® Stock Products only. Please see chart to the right for minimum purchase amounts to qualify for free delivery. Free delivery does not apply to rowing or paddle docks.
3. Connect-A-Dock, RGC® Boat Lifts, canopies & accessories – free delivery applies to products in stock only.
4. If you want your product installed, please inquire on rates for this service – free delivery does not apply.
5. Additional fees apply for wide loads (assembled boat lifts) and ferry charges, if needed.
6. Purchases under \$1000 are subject to a \$2 per mile one way charge from Ferrisburgh, VT. A ground shipping method/charge by another source such as Common Carrier or UPS may be more feasible depending on product purchased.

Minimum Purchase Amount (not including sales tax)	Free Delivery from Ferrisburgh, VT (Distance based on Google Maps)	Delivery Charge one-way (over the free mile range)
\$ 1,000	25 miles	\$2 /mile
\$ 2,000	50 miles	\$2 /mile
\$ 4,000	100 miles	\$2 /mile
\$ 6,000	150 miles	\$2 /mile
\$ 8,000	200 miles	\$2 /mile
\$10,000	250 miles	\$2 /mile



A Aluminum Swim Float

Aluminum Swim Float

- Lightweight aluminum frame
- Optional powder coated frame
- Includes 3' aluminum ladder
- Removable decking panels



All swim floats include 3' aluminum ladder

A Aluminum Swim Float *(shown above)*

Ideal for use in small lakes or bays. One piece lightweight aluminum frame with polyethylene floats. Includes 3' aluminum ladder and removable decking panels.

***SALE**

5% off NyloDeck Stock docks

**see page 13 for sale details & restrictions.*

Stock Size	Weight*	Net Buoyancy
8' x 8'	155 lbs.	960 lbs.

**Weight is with decking removed.*

Custom size swim floats available, please contact us for details. Ipe hardwood or other composite decking options available.

CEDAR
Price
\$ 1,709

ALUMINUM
Price
\$ 2,139

NYLODECK®
Price
\$ 2,359

see decking details on p. 13



Powder Coated Swim Float & Ladder

Optional powder coating for your swim float and ladder. Available on all our swim floats (aluminum and steel). Please call for pricing and allow for additional order time.



B Galvanized Steel Swim Float

Heavy Duty Galvanized Steel Swim Float

- Two-piece galvanized steel frame
- Optional powder coated frame
- Includes 3' aluminum ladder
- Removable decking panels



Heavy duty galvanized steel swim float dismantles into two pieces for ease of handling.

B Heavy Duty Galvanized Steel Swim Float (shown above)

Ideal for rough water. Dismantles into two pieces for ease of handling. Includes 3' aluminum ladder and polyethylene floats.

Stock Size	Weight*	Net Buoyancy	CEDAR	NYLODECK®
			Price	Price
8' x 8'	226 lbs.	884 lbs.	\$ 1,789	\$ 2,429
8' x 10'	235 lbs.	850 lbs.	\$ 1,969	\$ 2,779
10' x 10'	437 lbs.	1963 lbs.	\$ 2,599	\$ 3,619

*Weight is with decking removed.
Custom size swim floats available, please contact us for details. Ipe hardwood or other composite decking options available.

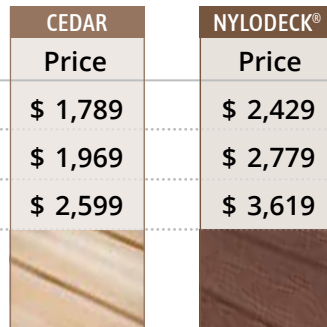

see decking details on p. 13

***SALE**

5% off NyloDeck Stock docks

*see page 13 for sale details & restrictions.



see page 3 for details

Swim Float Anchors

Light Duty Swim Float Anchor Kit: **\$159**
includes light duty anchor block (18" x 8", 180 lbs), shackles, swivel, 3' of 3/8" chain & (2) 10' nylon ropes

Nylon extension of rope: 14' (\$10), 18' (\$13), 22' (\$16)

Heavy Duty Concrete Anchor: **\$130**
2' x 2' x 8", 400 lbs

Heavy Duty Float Anchor Harness: **\$149**
includes shackles, swivel & (2) nylon ropes

3/8" Galvanized Chain: **\$4.50** per foot
(amount of chain needed is 1.5 x the water depth)





Pond Docks

- **NEW** 4' × 18' (4) piece aluminum frame pond dock designed for common carrier shipping
- 4' × 16' and 4' × 20' sizes available with galvanized steel frame
- Removable decking panels
- Optional powder coated frame
- Includes (2) 3 ft. long 1 1/2" pipes

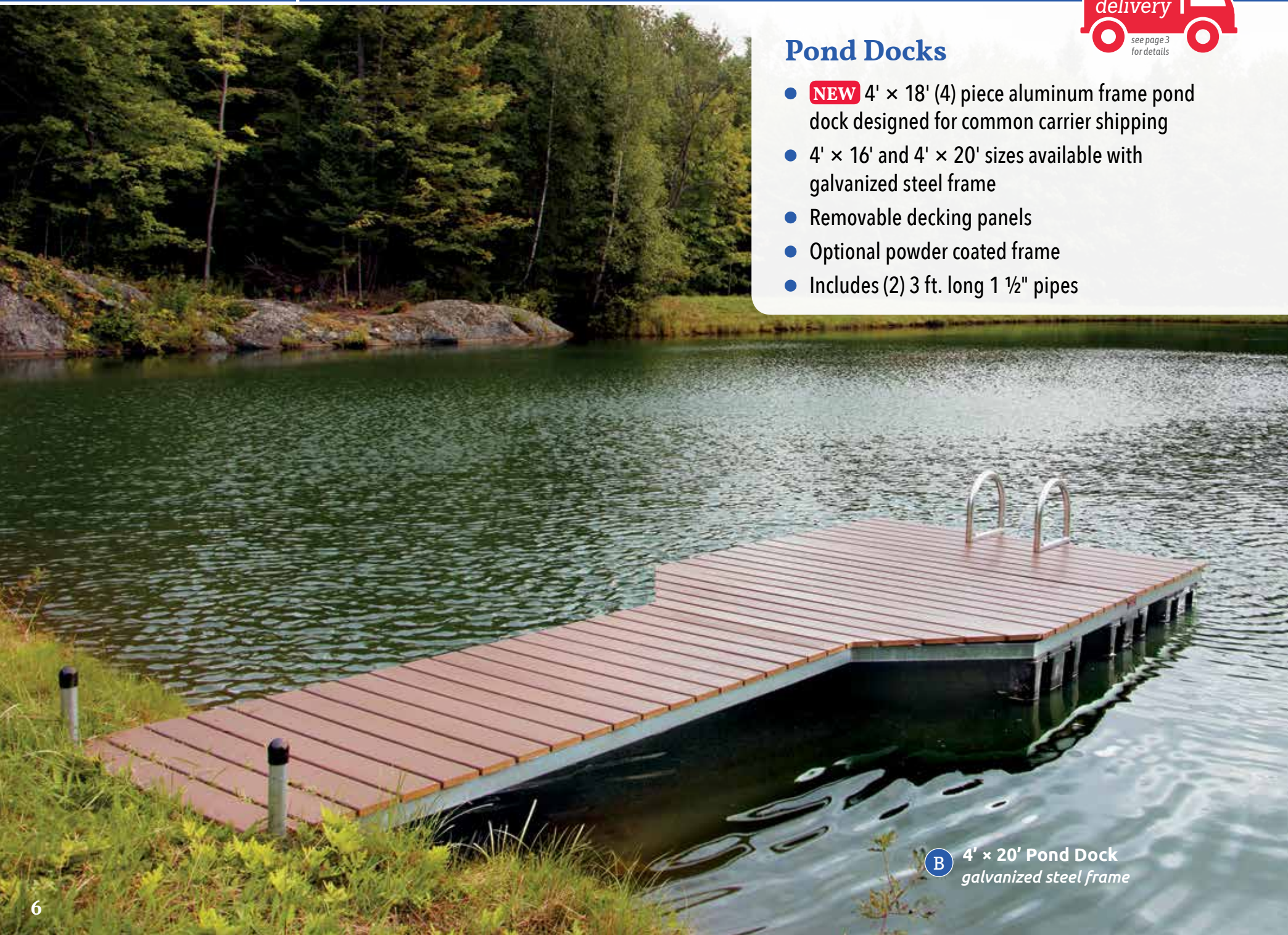

B 4' × 20' Pond Dock
galvanized steel frame

NEW *Aluminum Pond Dock* shippable to 48 U.S. States

Our new 4-piece *shippable* 4' x 18' pond dock features an aluminum frame and removable decking panels. Optional skirt boards available.

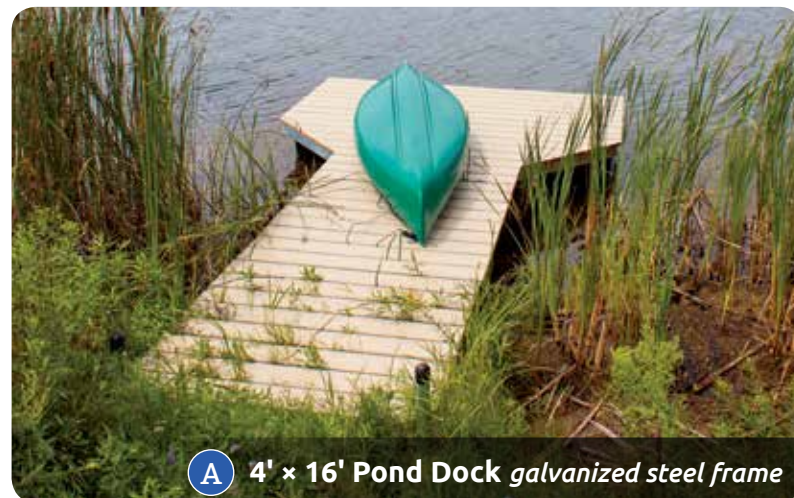

Pond Docks

Galvanized steel frame, or our *new* shippable aluminum frame pond docks feature removable decking panels and black polyethylene floats. Includes (2) 3 ft. long 1 1/2" pipes. *Optional powder coated frame (call for pricing).*

see decking details on p. 13

Stock Size	Weight*	CEDAR Price	NYLODECK® Price
Galvanized Steel Frame			
A 4' x 16'	370 lbs.	\$ 2,139	\$ 2,989
B 4' x 20'	450 lbs.	\$ 2,859	\$ 4,039
Aluminum Frame (4-piece shippable)			
C 4' x 18'	360 lbs.	\$ 2,959	\$ 4,139

*Weight is with decking removed.

Ipe hardwood or other composite decking options available.

***SALE**

5% off NyloDeck Stock docks

*see page 13 for sale details & restrictions.



Aluminum Ladders
(optional, shown on page 8)

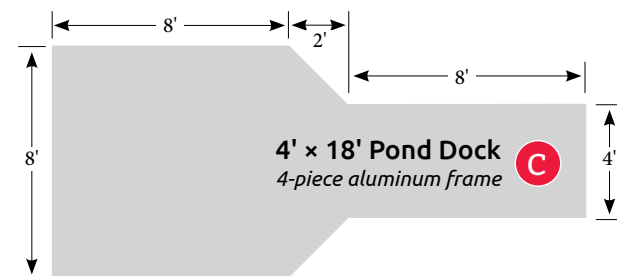
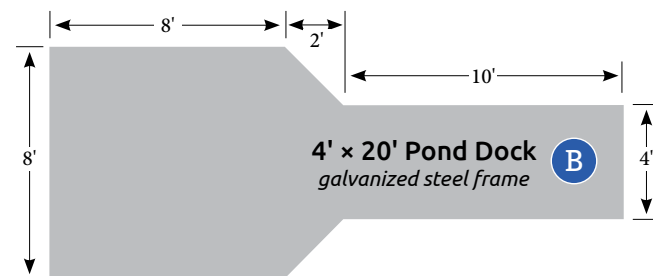
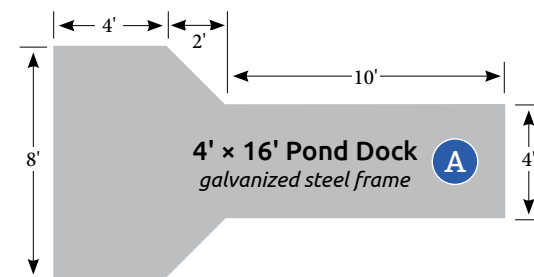



Dock Ladder
(aluminum finish)

Dock Ladders (available for all dock systems)

One-piece, removable vertical ladder with 1 1/2" tubular aluminum frame and arched, slip resistant 4" treads for added comfort with bare feet.

Stock Size	ALUMINUM	POWDER COATED
3' ladder	\$ 229	\$ 355
4' ladder	\$ 249	\$ 379
5' ladder	\$ 269	\$ 409

Please allow additional order time for powder coated ladders.

Dock Ladder
(powder coated finish)



Optional Powder Coated Finish (black)

Please note any dock compatibility exclusion(s) for options and accessories. Please be sure to identify your style of dock when placing orders for options.



Standard Aluminum Finish

Shallow Water Stairs (available for all leg & wheel docks)

One-piece welded aluminum structure with aluminum handrails down each side and non-slip treads with adjustable footpads.

Stair Size	ALUMINUM	POWDER COATED	Elevation ¹
4 step	\$ 599	\$ 789	37" - 49"
5 step	\$ 649	\$ 859	45" - 57"
6 step	\$ 699	\$ 929	53" - 65"

Please allow additional order time for powder coated stairs.

¹ Accommodates elevation from deck surface to lake bed.



Shallow Water Stairs

shown above with optional powder coated finish (special order)

Lower Access Platform *for swimming & kayaking*

Stationary leg docks are often quite a distance above the waters' surface, making accessing the water for swimming or kayaking very difficult. Our lower access platform is designed to provide you with a safe transition to the water. Add one of our aluminum ladders to gap the distance from your dock to the platform to safely transition to the lower platform.



- Designed to provide lower access for swimming or using your paddle crafts
- Add our aluminum ladder (see page 8) to transition down to the platform
- Overall frame size: 15" wide x 9' 3" long designed to be used alongside any 8-10' long dock with 1 1/2" support pipes
- 5" tall aluminum frame with Sure-Step® flow-thru, anti-slip decking
- Adjustable sleeves that slide over 1 1/2" support pipes



Lower Access Platform: **\$729**



Boarding Handle

Made with marine-grade aluminum, the boarding handle provides a safe handhold when boarding your boat. Mounts available for any **Dock Doctors** dock systems or a universal mount to attach to any dock frame. Height from mount to top of handle is 48".

Boarding Handle: **\$95**

Track Mount: **\$62**

please call for pricing on other mount styles.

Sliding Boarding Step \$889

Bridges the gap from your dock to your boat



Remove the gap to transition safely to/from your boat. Securely attaches to your existing dock. Find out more at: www.thedockdoctors.com/boardingstep



Shipping Available

Protect your boat and dock with our adjustable vertical fenders

(available for all dock systems)

Our unique vertical fender design is adjustable on the mount which is often necessary due to lake level and boat style. Add a fender cleat kit (see G below right) for a complete securing system for your boat.

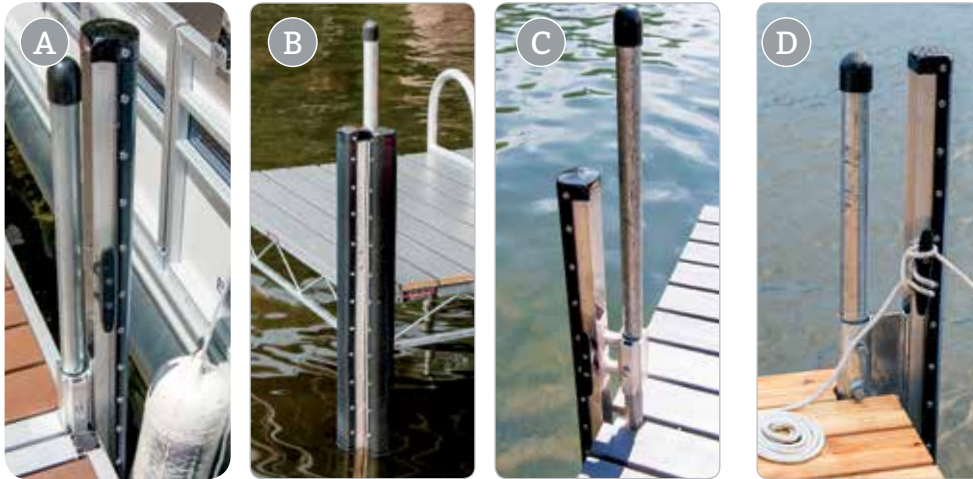

Two forms of adjustment:

- 1 Up and down on the mount and
- 2 Up and down on the pipe.

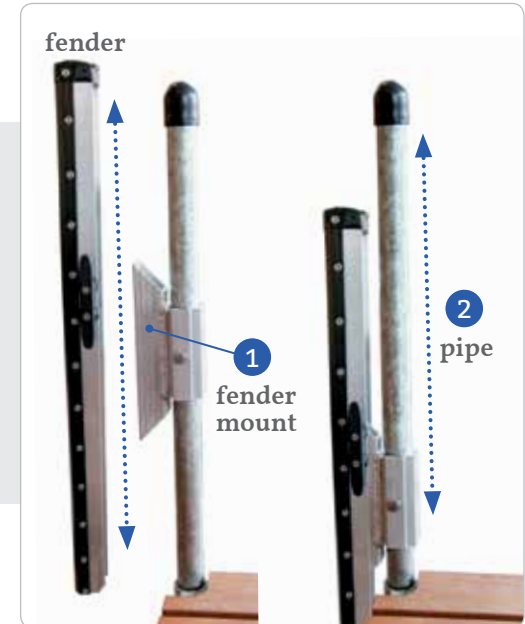

Vertical Fenders

Fender Style	Mounting Style	3' long	4' long
<i>For all Aluminum Leg & Wheel Docks & Steel Truss Leg Docks with 1 1/2" pipe:</i>			
A Fender	1 1/2" pipe mount	\$ 139	\$ 159
B Double Corner Fender	1 1/2" pipe mount	\$ 249	\$ 299
<i>For all Steel Truss Wheel Docks with 1 1/2" pipe:</i>			
C Fender with offset	1 1/2" pipe mount	\$ 149	\$ 175
<i>For all Mega Leg Docks with 3" pipe or Custom Articulating Docks with 2" pipe:</i>			
D Fender	2" or 3" pipe mount	\$ 173	\$ 195
<i>For all Aluminum "Track-Frame" Floating Docks:</i>			
E Fender (not shown)	Track Mounted	\$ 152	\$ 174
<i>For all Aluminum "Track-Frame" Floating Docks - includes spud mount:</i>			
F Fender (not shown)	Spud Anchor Mounted	\$ 330	\$ 350



Fender Cleat Kit
2 cleats included per kit

Fender Cleat Kit

Designed to be used with the 3' or 4' fenders listed to the left. Includes (2) cleats per kit that bolt onto the fender mount.

\$ 38.⁹⁵/ kit



A Edge Fender

High quality, non-marring black edge fender. Available for all aluminum “track-frame” floating docks, and custom galvanized steel floating dock systems.

\$ 6.⁹⁵ per foot (material only, not installed, not including fasteners)

\$ 10.²⁵ per foot (installed with stainless steel fasteners*)

*installation available on new dock orders only

Cleats

B Pipe Cleat (for 1 1/2" pipe)

A single cleat mounted to a sleeve that slides over the leg pipe. Available for all leg & wheel docks except the mega leg & wheel docks.

\$ 31.⁹⁹ / each

C Track Cleat

Designed to slide along the track of our floating aluminum track dock systems (see pp 38-40).

\$ 19.⁹⁹ / each

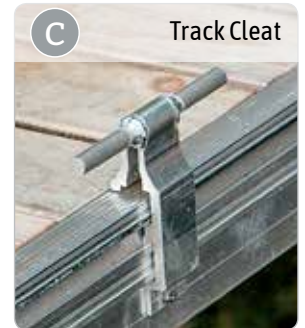
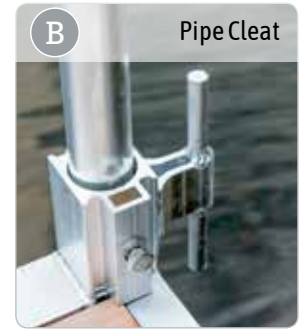

D Taylor Made Mooring Whips

Mooring whips with fixed angle base. Two-piece kit, will need to be epoxied (epoxy included with kit). Recommended for low profile boats such as bass boats, runabouts and sport boats.

MW120: **\$ 545**

MW140: **\$ 619**

(for 18' - 23' boats / 2,500-5,000 lbs.) (for 24' - 28' boats / 5,000-10,000 lbs.)

Disclaimer: Some docking conditions may be too rugged for this product.

E Mooring Whip Dock Mounts (for Dock Doctors docks)

Required for docks with removable decking. **\$ 135** for Taylor Made mooring whip models listed above only





A Post Covers

Post covers camouflage the 1½" leg pipe for a more rustic appearance. Available in either Cedar or Trex® composite material.

Style	Cedar*	Trex®**
Post Cover	\$ 219	\$ 219
Post Cover with 4' bumper	\$ 329	\$ 329
Post Cover with 4' bumper & cleats	\$ 376	\$ 376

shown with pyramid style cap with built in light

*Includes stamped copper pyramid style cap. **Includes matching Trex® pyramid or flat top style cap. †Trex® colors available: Black, Gravel Path, Rope Swing, Tree House, Vintage Lantern & Fire Pit.

B Cedar Post Cover Caps

Cast aluminum powder coated finish – available in black (optional other colors available). *Note: post caps listed below are not available for Trex® post covers.*

Style	Black
B1 Pyramid Style Cap	\$ 57
B2 Pyramid Style Cap with built in 110 volt light and ribbed glass	\$ 112
B3 Flat Top Style Cap (not shown) with built in 110 volt light and ribbed glass	\$ 112



shown with (B2) pyramid style cap with light



*Note: Light kits do not include wiring. Both 12 volt & 110 volt are available.



skirt boards

Skirt boards for our galvanized steel truss dock systems provide the aesthetic appearance of a wooden dock.

C Skirt Boards

Used to camouflage the truss frame to give the appearance of a wooden dock system. *Please inquire for further details.*

D Flag Poles

Add beauty to your waterfront property with a telescoping flagpole. These poles have no ropes, chains or pulleys so you do not have to worry about knots and tangles and they are virtually



noise-free. Each section of the pole raises and lowers easily. 16' tall telescoping aluminum flagpole includes a 3" gold aluminum ball ornament, a double flag harness to fly two flags or fly at half mast, a 3' x 5' nylon USA flag with embroidered stars and sewn stripes. Other pole heights available as special order.

Flag Poles

Style	Suggested Retail	Our Price
D1 Silver Finish Flag Pole	\$ 339	\$ 289
D2 Black Finish Flag Pole	\$ 369	\$ 309
Dock Mounts		Price
D3 Deck surface mount		\$ 80
D4 Side mount		\$ 80
D5 Pole mount for docks with 1 ½" leg pipe		\$ 80

Decking Choices

CEDAR



CEDAR is a natural, cost effective decking option that is naturally resistant to decay and insects. Red cedar will weather to a soft, silvery gray. *Cons:* Over time will absorb moisture and weather unless sealed with a preserving stain.

ALUMINUM



ALUMINUM resists the growth of mold and mildew and won't rust, rot, split or stain. The powder-coated finish eliminates glare from the aluminum. The non-slip, rigid, surface is low-maintenance and cool to the touch. *Cons:* Can sound metallic when walking on it, especially on our docks with removable panels.

SURE-STEP®



SURE-STEP is a slip-resistant, polypropylene surface that allows water and sunlight through to help conserve the underwater ecosystem. Preferred option for dock structures that are situated close to the water so waves will pass through the decking, adding minimal resistance. *(Available on our aluminum docks and swim floats).* *Cons:* Only available in certain dimensions, so may not be a viable option for many applications.

NYLODECK®

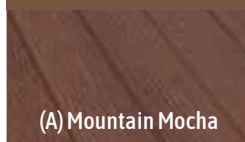

(A) Mountain Mocha



(B) Harbor Gray

NYLODECK is environmentally-friendly and made using 100% recycled carpet fiber and contains no wood or PVC. NyloDeck® is the only 1 inch composite deck board rated to span joists at 24 inches on center. It is twice as strong as other leading composite decking materials. Lightweight and easy to work with and is impervious to moisture, mold, mildew and insects. *Cons:* Not a natural wood.

NyloDeck® Sale Details

Please note dock width limitations on color options.

- **Mountain Mocha:** available for dock widths from 4'-8'.
- **Harbor Gray:** available for 4' wide docks only.
- **Mountain Mocha:** only color option for Paddle & Rowing Docks.

*****SALE ONLY APPLICABLE WHILE SUPPLIES LAST*****
Sale only applies to the section prices - does not apply to other options, accessories, delivery or installation.

Other composite decking options available.
Please contact us for details.

IPE



IPE is extremely hard, very durable and naturally resistant to rot and insects. Ipe's strong, resilient properties make it an excellent material choice for marine applications. *Cons:* It is a natural wood, therefore there will be inconsistencies with regard to color, weathering and texture. Due to the density of Ipe, it is heavy and hard to drill and cut, therefore more labor intensive than working with other decking materials.



A Dock Mounted Roller

A single 12" keel roller designed to assist you when moving canoes, kayaks, or other small crafts on or off the dock. **\$ 109**



universal mount
mounts to dock
frame or decking



track frame mount
for aluminum floating
docks shown on p. 38-40



B Single Craft Storage Arms (dock mounted)

A pair of small craft storage arms featuring vinyl hull guards, and end caps with built in tie-down openings. Available in Universal Pipe Mount (fits all docks with 1 1/2" pipe).

\$ 165 STANDARD ALUMINUM

\$ 195 POWDER COATED BLACK



C 2-Craft Storage Rack (dock mounted)

Our dock mounted small-craft storage racks mount to the frame of your dock to store kayaks, canoes, paddle boards, and other small crafts.

\$ 495 STANDARD ALUMINUM

\$ 655 POWDER COATED BLACK

Note: Fits Dock Doctors Steel Truss & Aluminum Track floating dock systems, as well as a Universal Mount for wood dock systems.

Please identify what style of dock this will be mounting to when ordering.



D 6-Craft Freestanding Storage Rack

Marine-grade aluminum frame freestanding storage rack with adjustable height arms. Arms feature vinyl hull guards and end caps with built in tie-down openings. Available in aluminum or powder-coated black finish.

\$ 879 STANDARD ALUMINUM

\$ 1175 POWDER COATED BLACK

See more styles in our Paddle Products catalog or on our website



All our products are proudly made in the USA



E 3-Craft Freestanding Storage Rack

Same features as our 6-craft rack on page 14, in a single-sided design.

\$ 659 STANDARD ALUMINUM

\$ 889 POWDER COATED BLACK

Freestanding Storage Rack: *optional accessories*



F Adjustable Feet

Ideal for uneven ground (includes 2 feet, mounting brackets and hardware).

\$155 STANDARD ALUMINUM

\$182 POWDER COATED BLACK



G Additional Support Arms

Includes 2 arms, mounting brackets and hardware.

\$105 STANDARD ALUMINUM

\$135 POWDER COATED BLACK



H Wall Mounted Storage Rack

Marine-grade aluminum frame *wall-mounted storage rack* with adjustable height arms. Arms feature vinyl hull guards and end caps with built-in tie-down openings. Available in aluminum or powder-coated black finish. Optional additional arms (see G at bottom left).

\$ 489 STANDARD ALUMINUM

\$ 679 POWDER COATED BLACK



Wall-mounted rack mounted vertically with additional arms added for multiple board storage.



Commercial Storage Rack

See our complete line of storage racks, including Commercial Racks in our [Paddle Products Catalog](#) or online at: www.thedockdoctors.com/paddle-products



Shipping Available



Easy Hassle Free Mounting
No Wiring Required

Solar Dock Post Lites

- Fits standard pipes (1 1/2" & 2" ID in size)
- 6" H x 3.5" diameter (UV stabilized polycarbonate)
- (1) Super bright LED (12 Lumens)
- Automatic night activation
- Fully sealed electronic circuit board
- Powerful solar panel
- Lasts 18+ hours on a full charge
- Replaceable 1.2v NiMH battery
- Two (2) post lites in each package



1 3/8" Dock Dots

The smallest solar lights you have ever seen! Easy to install in minutes with a quick 1 3/8" drill bit or hole saw.

Available in: **\$ 55.95**
white/blue/green/amber/red
package of 4

Deck Lights

Industrial strength solar powered dock light made from marine grade anodized aluminum for superior protection in harsh marine environments.

Available with white LEDs only **\$ 34.95** each



Sea Gull Eliminators

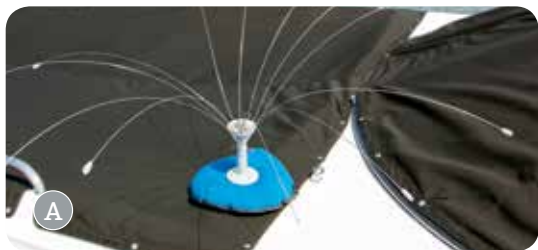

A Bird-B-Gone® Bird Spider 360°

The Bird-B-Gone's spider's spinning motion is effective at deterring birds from landing on your boat, swim raft or dock. Stainless steel arms with scuff-preventing polycarbonate tips move with the breeze. Mount permanently (screws included) or use an optional rail, bimini or sandbag mount.

Model #MMBS400SPN (4' diameter) **\$ 49.99**
Model #MMBS800SPN (8' diameter) **\$ 59.99**



B Bird-B-Gone® 360° Repellent

6' diameter, wind driven rotator keeps birds from roosting on your boat, swim raft or dock. Includes standard mounting block (screws included). *Optional rail, bimini or portable sandbag mounts sold separately.*

Model #MMRPL360 **\$47.99**



Rail Mount

For mounting to boat railing 1" to 1.86" in size and other surfaces that will accept a C-clamp.

Model #MMRLMNT **\$22.99**



Sandbag Base

Attaches directly to either style repeller and comes with all the necessary hardware. Has eyelets around outer ring for extra security. *Weights 8 lbs.*

Model #MMBSBB-SB **\$41.99**



Boat Base

Used to secure either style bird repellents to masts, spreaders and other areas. Comes with all the necessary hardware.

Model #MMBSBB2 **\$9.99**

Dock Adjustment & Installation Tools

A Adjustment Kit

Adjust the level of your dock with this kit that slides over the 1 ½" leg pipe. Available for all leg & wheel docks with 1 ½" pipe. Sold as a pair (winch with sleeve and hook).

\$ 255 / pair



B Spud Puller & Pounder Kit

This (2) piece system aids in the installation and removal of spud pole anchors for our floating dock systems.

2" puller/pounder kit: \$ 259

3" puller/pounder kit: \$ 325

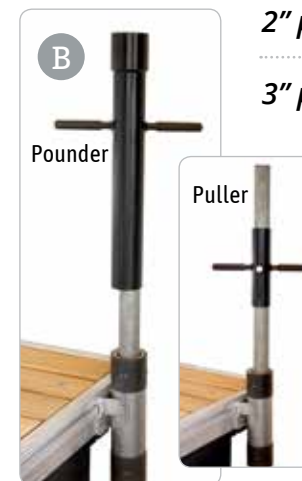

Boat Lift Installation & Removal Tools

Make the seasonal installation and removal of your boat lift easier with a wheel kit and/or air bag lift system.

A Boat Lift Wheel Kits

Specifically designed for use with RGC® boat lifts and can be modified for use with hydraulic boat lifts. Includes a pair of welded galvanized steel mounting brackets and (2) heavy duty polyethylene wheels.

BLW2045 (fits 2,000 - 4,500 lb. lifts): \$ 305 / pair

BLW5060 (fits 5,000 - 6,000 lb. lifts): \$ 320 / pair



B Air Bag Lift Kits

Inflatable 250 and 500 lb. capacity air bags with attachment strap to float your boat lift for seasonal installation and removal. Ideal when used in conjunction with a wheel kit (see photo on left). Includes connecting kit (carabiner and strap).

250 lb. capacity: \$ 245

500 lb. capacity: \$ 365



Our lightweight **aluminum portable stairs** are rigid and adjustable, with features designed to accommodate a variety of waterfront applications. Offering a lifetime of virtually maintenance free features, these quality aluminum stairs are an economical solution for waterfront access and ideal for replacing your old wooden steps.

Aluminum Stair Features

- Readily available in lengths up to 18' 9"
- Adjustable rise & run (27 to 44 degrees) to accommodate your site
- Custom fabrication available for specific applications & lengths
- Lightweight & easy to carry for a two-person installation
- Non-skid, 28" wide stair treads
- Marine grade aluminum extrusions with stainless steel fasteners
- Rounded aluminum handrails on both sides
- Optional adjustable footpads for base of stairs
- Includes mounting bracket

(designed for easy seasonal installation & removal of stairs)

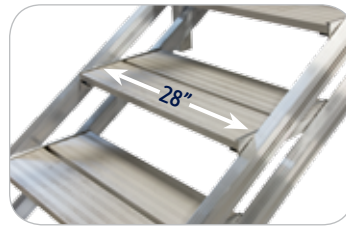

Non-skid, 28" wide
stair treads



3' x 4' stair platform

Stair platform for top and/or bottom of stairs.

Aluminum Stairs

All stairs are 28" wide

All stairs can be assembled to fit any distance between the minimum and maximum rise.

# of Steps	Price*	Minimum Rise @ 6" (27°)	Run with 6" rise	Length with 6" rise	Maximum Rise @ 9" (44°)	Run with 9" rise	Length with 9" rise	Weight
4	\$ 715	2' 0"	4' 7"	5' 0"	3' 0"	3' 11"	4' 11"	65 lbs.
6	\$ 998	3' 0"	6' 6"	7' 2"	4' 6"	5' 6"	7' 1"	93 lbs.
8	\$ 1,189	4' 0"	8' 5"	9' 4"	6' 0"	7' 1"	9' 3"	115 lbs.
10	\$ 1,419	5' 0"	10' 4"	11' 6"	7' 6"	8' 8"	11' 5"	142 lbs.
12	\$ 1,669	6' 0"	12' 3"	13' 8"	9' 0"	10' 2"	13' 7"	164 lbs.
14	\$ 1,889	7' 0"	14' 2"	15' 10"	10' 6"	11' 9"	15' 9"	173 lbs.
16	\$ 2,155	8' 0"	16' 1"	18' 0"	12' 0"	13' 3"	17' 11"	188 lbs.
n/a	\$ 579	3' x 4' stair platform (standard duty aluminum with aluminum decking)						32 lbs.

*Price includes mounting bracket (fasteners to existing platform not included); handrails down each side and slip resistant stair treads. Stair uprights remain vertical in any rise. Optional top and/or bottom stair platform in 3' x 4' standard duty aluminum (see photo on p. 18). Optional pair of Adjustable Footpads includes brackets to mount to bottom of stairs, 1 1/2" aluminum support pipes 24" long, black safety caps & aluminum footpads. Requires stair frame drilling on-site to mount.

Assembly Options: Unassembled: Requiring assembly on site to contour to desired rise (note: some drilling is required). Pre-assembled: Factory assembled and adjusted to desired rise (note: additional assembly charge will apply).

*Prices do not include shipping/delivery – please call for pricing.



mounting bracket



rounded aluminum handrail



(optional)

Adjustable Footpad

\$189.⁰⁰ / pair

Requires drilling stair on-site to mount.





Our *standard duty aluminum frame leg and wheel docks* are designed for protected sites with minimal wave action, feature an exceptionally strong aluminum frame. These strong yet lightweight docks can be installed by one person.



Fill out our site survey and we will send you a free estimate and conceptual layout customized to your property.
www.thedockdoctors.com/site-survey

Standard Duty Aluminum Leg & Wheel Docks



- Exceptionally strong aluminum frame
- Support stanchions built into the frame, for an obstruction-free dock edge
- Removable decking in cedar, aluminum, NyloDeck® composite - or attached Sure-Step® decking
- Ipe hardwood or other composite decking options available



Standard duty aluminum docks used to create a shoreside deck area.



Standard duty aluminum docks with NyloDeck decking and 4,500 lb. vertical boat lift.



EASY one person install

Our innovative connector clips and lightweight sections allow for one person to easily connect sections together and install the dock system.



Standard duty aluminum leg dock with Sure-Step® decking and our freestanding launch port system (see page 51).



Standard duty aluminum wheel docks easily roll in and out as the water fluctuates during the season.

Dock mounted roller (see page 14)



Assembly Components

Connector Clips
for connecting
docks together
\$ 24.00 set of 2



Safety Cap
for 1 1/2" pipe
\$ 5.50 each



**Aluminum
Pipe 1 1/2"**
cut to length
pending
water depth
\$ 6.95 per foot



**Footpad
(aluminum)**
\$ 34.00 each



Cross Braces
(optional)
stabilizes docks in
deeper water
\$ 145.00



4' x 8' Leg Dock



4' x 12' Wheel Dock



Standard Duty Aluminum: Leg & Wheel Docks

see decking details on p. 13

Size	Weight*	CEDAR Price	ALUMINUM Price	NYLODECK® Price	SURE-STEP® Price
LEG DOCKS					
4' x 8'	49 lbs.	\$ 575	\$ 795	\$ 909	n/a
4' x 10'	63 lbs.	\$ 659	\$ 919	\$ 1,069	n/a
4'3" x 8'5"	99 lbs.	n/a	n/a	n/a	\$ 765
4'3" x 10'5"	125 lbs.	n/a	n/a	n/a	\$ 879
WHEEL DOCKS					
4' x 12'	95 lbs.	\$ 1,109	\$ 1,415	\$ 1,569	n/a
4'3" x 12'5"	149 lbs.	n/a	n/a	n/a	\$ 1,375

Dock pricing includes frame and removable decking. Wheel dock pricing includes (1) pair of wheels and axle assembly. The necessary assembly components are sold separately.

*Weights for docks do not include the decking with the exception of docks with Sure-Step® decking, which attaches directly to the dock frame and is not removable.

***SALE**

5% off NyloDeck Stock docks
*see page 13 for sale details & restrictions.



Our *medium duty aluminum frame leg and wheel docks* offer superior strength and stability, featuring taller frames and longer and wider sections than our standard duty frames. Easy to install, the support stanchions are built into the frame and flush to the sides of the dock, allowing for an obstruction-free dock edge.

Medium Duty Aluminum Leg & Wheel Docks

- Exceptionally strong, 7" tall aluminum frame
- Support stanchions built into the frame for an obstruction-free dock edge
- Removable cedar, NyloDeck® composite or aluminum decking panels
- Ipe hardwood or other composite decking options available



Medium duty aluminum leg docks with NyloDeck® decking and single craft storage arms (see page 13).



Medium duty aluminum leg docks with NyloDeck® decking.



EASY to install

No sharp edges on underside of frames make our aluminum docks easy on the hands for carrying.

“Very happy with your product and it was easy to assemble, stable and steady, no bounce when you walk on it.” — M.G.



Above Top: Medium duty aluminum docks with cedar decking and 2,000 lb. vertical boat lift.

Inset: Dock sections installed side-by-side to create an “L” shape with optional triangle section for more deck space.



Right: Medium duty aluminum leg docks with cedar decking, aluminum ladder (see page 8) and pipe-mounted flagpole (see page 12).





Medium duty aluminum leg docks with aluminum decking. Accessed by our adjustable aluminum stairs (see pages 18-19).



Medium duty aluminum leg docks with our kayak/canoe roller (see p. 14).



Washington, NH

Medium duty aluminum leg docks with NyloDeck® decking at a town beach in Washington, NH.



Assembly Components

Connector Clips
for connecting
docks together
\$ 34.00 set of 2



Safety Cap
for 1 1/2" pipe
\$ 5.50 each



**Aluminum
Pipe 1 1/2"**
cut to length
pending
water depth
\$ 6.95 per foot



**Footpad
(aluminum)**
\$ 34.00 each



Cross Braces
(optional)
stabilizes docks in
deeper water
\$ 145 (4' wide docks)
\$ 155 (6' wide docks)



6' x 8' Leg Dock



4' x 16' Wheel Dock

Medium Duty Aluminum: Leg & Wheel Docks

see decking details on p. 13

Size	Weight*	CEDAR Price	ALUMINUM Price	NYLODECK® Price
LEG DOCKS				
4' x 8'	71 lbs.	\$ 729	\$ 955	\$ 1,059
4' x 10'	85 lbs.	\$ 839	\$ 1,097	\$ 1,225
4' x 12'	100 lbs.	\$ 933	\$ 1,245	\$ 1,405
6' x 8'	89 lbs.	\$ 944	\$ 1,259	\$ 1,425
6' x 10'	107 lbs.	\$ 1,087	\$ 1,479	\$ 1,709
6' x 12"	125 lbs.	\$ 1,217	\$ 1,709	\$ 1,969
3' x 3' triangle corner	30 lbs.	\$ 419	\$ 489	\$ 529
WHEEL DOCKS				
4' x 16'	129 lbs.	\$ 1,649	\$ 2,069	\$ 2,309
6' x 16'	161 lbs.	\$ 1,869	\$ 2,509	\$ 2,849

Dock pricing includes frame and removable decking. Wheel dock pricing includes (1) pair of wheels and axle assembly. The necessary assembly components are sold separately.
*Weights for docks do not include the decking.
Ipe hardwood or other composite decking also available as a special order.

***SALE**

5% off NyloDeck Stock docks
*see page 13 for sale details & restrictions.



Heavy Duty Steel Truss Leg & Wheel Docks

- Designed for exposed sites
- Heavy duty 9" galvanized steel truss frame with adjustable leg stanchions built into frame
- Removable decking in cedar or NyloDeck® composite
- Ipe hardwood or other composite decking options available
- 10 year limited warranty



Above: Steel truss leg docks with NyloDeck® Decking, vertical fenders, solar post lites and dock mounted roller (see accessories on page 8-17).



Add our aluminum ladder or shallow water stairs.



See pages 8-17 for full details and more accessory options.



Above: Steel truss leg docks with 6' x 10' sections and cedar decking with our portable aluminum stairs (see p. 18-19) which are utilized as a transition over the rocky shoreline.



6' wide sections optimize dock space for all your activities – shown with optional cedar post covers (see page 12).



6' wide leg docks with 2' x 10' catwalk and our lower access platform – for swimming and boarding paddle crafts (see page 9).

Assembly Components

Connecting Brackets

each connection requires (4)

End-to-end: \$ 13/ea

Side-by-side: \$ 13/ea

Catwalk (3"): \$ 11/ea

catwalk requires (2) 3" brackets & (2) truss end-to-end brackets



Safety Cap

for 1 1/2" pipe

\$ 5.⁵⁰ each

Galvanized Pipe 1 1/2"

cut to length

pending water depth

\$ 6.⁹⁵ per foot



Footpad

(galvanized steel)

\$ 36.⁰⁰ each



Dock Panel Securing Cord

\$ 5.²⁵ set of 4



Cross Braces

(optional)

stabilizes docks in deeper water

\$ 145 (4' wide docks)

\$ 155 (6' wide docks)



4' x 10' Leg Dock



4' x 16' Wheel Dock

Heavy Duty Steel Truss: Leg & Wheel Docks

see decking details on p. 13

Size

Weight*

CEDAR

NYLODECK®

Price

Price

LEG DOCKS

4' x 8'

100 lbs.

\$ 839

\$ 1,159

4' x 10'

115 lbs.

\$ 899

\$ 1,289

6' x 8'

125 lbs.

\$ 1,086

\$ 1,465

6' x 10'

150 lbs.

\$ 1,149

\$ 1,759

2' x 10' catwalk (std duty)

75 lbs.

\$ 479

\$ 709

3' x 3' triangle corner

45 lbs.

\$ 295

\$ 385

WHEEL DOCKS

4' x 16'

208 lbs.

\$ 1,785

\$ 2,429

6' x 16'

230 lbs.

\$ 2,019

\$ 2,969

4' x 16' with 4' x 8' L

328 lbs.

\$ 2,635

\$ 3,599

6' x 16' with 4' x 8' L

350 lbs.

\$ 2,869

\$ 4,169

 Ipe hardwood & other composite decking also available as a special order.

Dock pricing includes frame and removable decking. Wheel dock pricing includes (1) pair of wheels and axle assembly. The necessary assembly components are sold separately. *Weights for docks do not include the decking.

***SALE**

5% off NyloDeck Stock docks

*see page 13 for sale details & restrictions.

Designed for use in rough and deep water applications, our *mega duty steel truss leg and wheel docks* feature taller frames, longer and wider sections, and larger diameter upright supports. Available in two stock sizes (or contact us for custom size dock options).



Mega Duty Steel Truss Leg & Wheel Docks

- Designed for use in rough & deep water applications
- 11" tall galvanized steel truss frame
- 3" diameter upright supports
- Stocked in 6' x 20' & 8' x 20' sizes (custom sizes available)
- Adjustable leg stanchions built into frame
- Removable cedar or NyloDeck® composite decking panels
- Ipe hardwood or other composite decking options available





Lake Champlain

Sliding Boarding Step \$889

Bridges the gap from your dock to your boat



Remove the gap to transition safely to/from your boat. Securely attaches to your existing dock. Find out more at: www.thedockdoctors.com/boardingstep

Above: Mega dock with NyloDeck® decking, aluminum gangway (see p. 41) and our ultimate boat lift with Sunbrella® canopy (see pages 60-63).



Shelburne, VT

Our mega dock used as shoreside access to a custom floating dock (see our *Custom Catalog*).

Heavy Duty vs. Mega Duty Frames

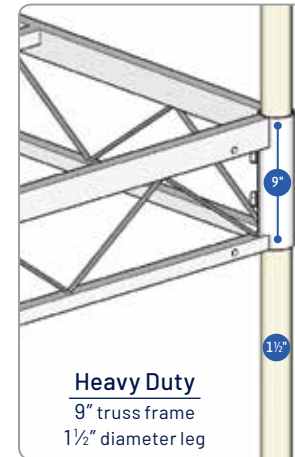

Heavy Duty
9" truss frame
1 1/2" diameter leg

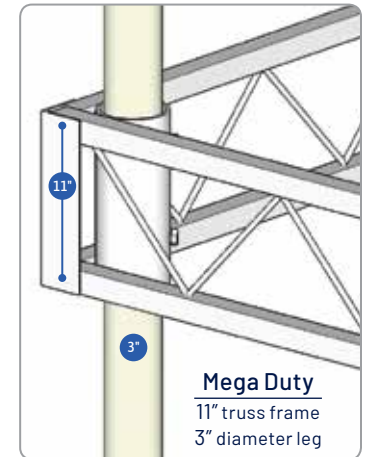

Mega Duty
11" truss frame
3" diameter leg

Assembly Components

Connecting Brackets
each connection requires (4)
\$ 25.00 each



Safety Cap
for 3" pipe
\$ 6.95 each



Galvanized Pipe 3"
cut to length pending water depth
\$ 12.95 per foot



Footpad
(galvanized steel)
\$ 49.00 each

Dock Panel Securing Cord
\$ 5.25 set of 4



Cross Braces
(not shown, optional stabilizes docks in deeper water)
\$ 175 (6' wide docks)
\$ 185 (8' wide docks)



Mega Dock Adjustment Kit
adjust the level of your dock with this kit that slides over the 3" leg pipe
\$ 439.00 pair



6' x 20' mega duty steel truss docks with 3' x 24' aluminum gangway, (2) 1,250 vertical PWC lifts, and our 6,000 lb. Ultimate boat lift.

Mega Duty Steel Truss: Leg & Wheel Docks



see decking details on p. 13

Stock Size	Weight*
LEG DOCKS	
6' x 20'	400 lbs.
8' x 20'	480 lbs.

WHEEL KITS	
for 6' wide docks	\$ 439
for 8' wide docks	\$ 449

 Ipe hardwood & other composite decking also available as a special order.

Pricing includes dock frame and removable decking. Custom sizes available as a special order. The necessary assembly components are sold separately. *Weights do not include the decking.

	CEDAR	NYLODECK®
	Price	Price
	\$ 3,569	\$ 4,719
	\$ 4,769	\$ 6,269

***SALE**

5% off NyloDeck Stock docks
*see page 13 for sale details & restrictions.



Our *medium duty aluminum floating docks* feature our “aluminum track” frame - allowing for easy mounting of hardware and accessories. These pre-manufactured “stock” docks are readily available for pick up, delivery or installation and are designed to be easily installed for the do-it-yourselfer.



Lake Bomoseen
Castleton, VT

Above: Medium duty aluminum floating docks with cedar decking, vertical fenders, aluminum ladder and anchored with our spud pole anchor mount.



Medium Duty Aluminum Floating Docks

- Used in residential & light commercial applications
- Exclusively designed frame by *The Dock Doctors*®
- Universal track-style 5" tall aluminum frame allows for easy mounting of hardware & accessories
- Removable decking in cedar, aluminum or NyloDeck® composite
- Ipe hardwood or other composite decking available
- Commercial grade, watertight, polyethylene shell floats (100% sealed with an expanded polystyrene foam)



Medium duty aluminum floating docks with optional powder coated frame upgrade and solar post lites (see p. 16).

Our heavy duty aluminum docks are ideal for sites with more exposure (see pages 4-5 & 53-55 in our custom catalog).





Medium Duty Aluminum: Floating Docks

see decking details on p. 13

Size	Weight*	CEDAR	ALUMINUM	NYLODECK®
		Price	Price	Price
FLOATING DOCKS				
4' x 12'	225 lbs.	\$ 1,469	\$ 1,779	\$ 1,959
4' x 16'	260 lbs.	\$ 1,839	\$ 2,255	\$ 2,490
6' x 12'	270 lbs.	\$ 1,979	\$ 2,469	\$ 2,719
6' x 16'	350 lbs.	\$ 2,479	\$ 3,115	\$ 3,474
8' x 12'	410 lbs.	\$ 2,441	\$ 3,075	\$ 3,429
8' x 16'	483 lbs.	\$ 3,015	\$ 3,859	\$ 4,325



Powder Coated Frame Upgrade
please call for pricing

BROWN **GREEN** **BLACK**

Pricing includes frame, decking and flotation. Anchoring, connecting hardware and shore mount sold separately. Note: Docks used as a shore ramp may require adjustable float frame and shore connection pending layout. Ipe hardwood and other composite decking options available. *Weights do not include the decking.

***SALE**

5% off NyloDeck Stock docks
*see page 13 for sale details & restrictions.

Assembly Components

Hinge Connector Kits

Hinge connector kits include bushing, stainless steel pins, wear and dampener system and protective cap (cap not shown).



\$ 164
(for 4' wide docks)
\$ 170
(for 6' wide docks)
\$ 176
(for 8' wide docks)

Anchor Mounts:



Spud Pole \$ 220
pipe sold separately

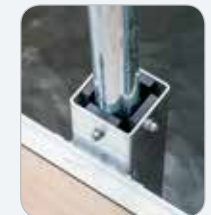

Chain Tube \$ 115
chain for anchoring
sold separately





Transitioning to our Mega Duty Leg Dock.



Two (2) 80' gangways during manufacturing.



Commercial gangways available with minimal time frames in any length/width

Aluminum Gangways

see decking details on p. 13

Size	Weight*	CEDAR Price	ALUMINUM Price
RESIDENTIAL 3' x 24'	295 lbs.	\$ 3,109	\$ 3,595
COMMERCIAL <i>custom size and length with minimal time frame</i>		<i>please call</i>	<i>please call</i>

*Weights listed do not include the decking.

Pricing for all gangways includes decking and handrails. Commercial quality gangways are readily available in any length and with other types of decking. Hinge connections and shore mounts sold separately.

Our *aluminum-frame paddle docks* feature heavy duty aluminum frames suitable for commercial or residential applications. Their modular design allow for a variety of layout options.



Heavy Duty Aluminum Paddle Docks

- 7" Aluminum Track Frame with 10"- 12" freeboard
(approximate – pending sections, size & decking choices)
- Heavy duty, stainless-steel connection hinges
- Optional powder coated frame
- Cedar decking, or upgrade to optional Ipe or Composite
- Foam filled black polyethylene floats
- Optional marine-grade black vinyl edge fender
- Optional debris diverter protects the dock from floating debris often seen in river settings



Optional angled ladder



Spud pole anchor example

Paddle Docks

Heavy Duty Aluminum

Standard Size

Price

8' x 20'	as low as \$5,459
10' x 20'	as low as \$6,669
8' x 16' ramp section	as low as \$4,169

Custom sizes and wider ramps available. Standard pricing includes aluminum frame, cedar decking and flotation. Site conditions, exposure, anchoring details and ramp requirements to be determined for final pricing.

NyloDeck® composite decking sale - see page 13 for details

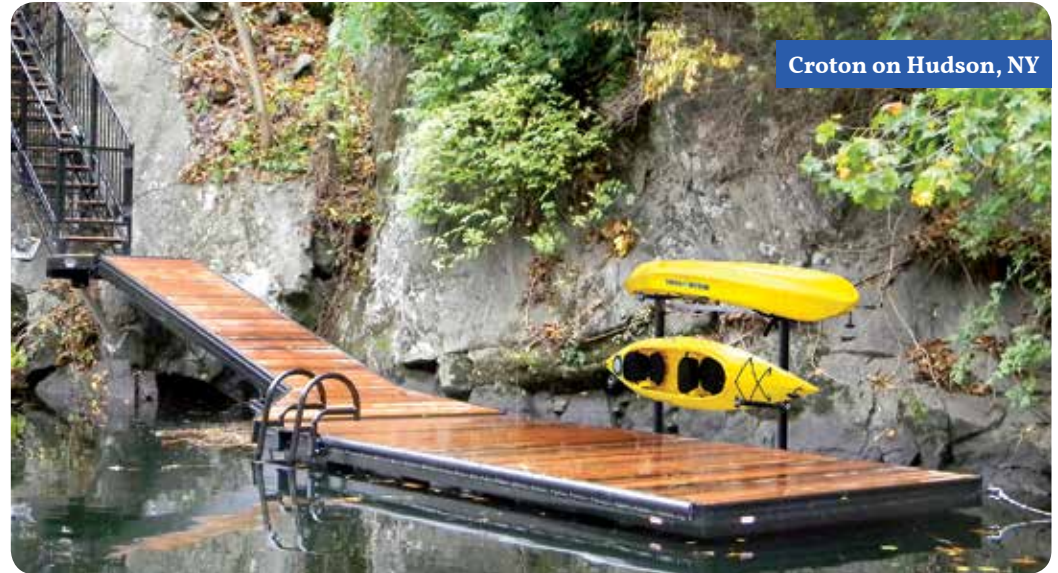

Powder coated heavy duty aluminum paddling dock with dock mounted kayak rack.



Paddle dock shown with composite decking & powder coated finish.



Our *heavy duty, aluminum-frame rowing docks* feature a modular design for a variety of layout options. Designed for commercial or residential applications.



- 7" Aluminum Track Frame with 6"- 8" freeboard
- Heavy duty, stainless-steel connection hinges
- Modular track-style frame allows easy additions of optional components and multiple layout options
- Foam filled black polyethylene floats
- Cedar decking, or upgrade to optional Ipe or Composite
- Optional marine grade black vinyl edge fender
- Optional debris diverter protects the dock from floating debris often seen in river settings

photos courtesy of Karen Bobotas



St. Paul's School, Concord, NH

Heavy duty aluminum frame rowing docks with Ipe decking.



Rondout Rowing Club, Kingston, NY

Heavy duty aluminum frame rowing docks with composite decking.



YMCA Camp Coniston, Croydon, NH

Rowing Docks

Heavy Duty Aluminum

Standard Size	Price
8' x 20'	as low as \$5,459
10' x 20'	as low as \$6,669
8' x 16' ramp section	as low as \$4,169
8' x 20' flared ramp section	as low as \$5,555

Custom sizes and wider ramps available. Standard pricing includes aluminum frame, cedar decking and flotation. Site conditions, exposure, anchoring details and ramp requirements to be determined for final pricing.

NyloDeck® composite decking sale - see page 13 for details

Accessories & Options	Price
Wheel Kit	\$829 / set
Angled Dock Ladder (aluminum)	\$389
<i>Items not shown:</i>	
Debris diverter - 8' long	as low as \$2,729
Debris diverter - 10' long	as low as \$3,409
Hinge connections	as low as \$335 / set
Edge Fender (black vinyl, installed on dock)	\$10. ²⁵ / lineal foot



Axle & Wheel mounts for seasonal installation and removal.



Angled ladder.



Versatile modular floating dock system by Connect-A-Dock.

Applications ideal for Connect-A-Dock products:

- Rowing / Sculling docks
- Small craft access for canoes & kayaks
- Floating dock slip in calm bodies of water
- Walkway in marsh wetlands

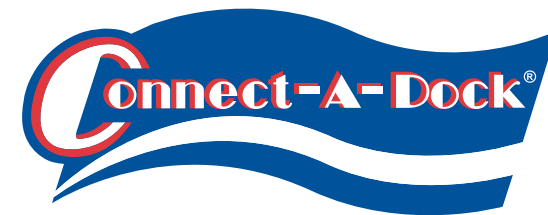

Connect-A-Dock benefits:

- Modular design
- Easy to install
- UV protected
- Environmentally friendly
- Does not contain CCA
- Salt water safe
- 8 year product warranty



Accommodates a variety of uses offering many modular sizes and freeboard heights.



Above: "1000 Series" lower profile system with small boat slip.



Above: "2000 Series" with optional railings on a public fishing pier.

Features:

- Wood grain anti-skid surface
- Ultra tough, polyethylene construction
- 1000 Series provides 8" of freeboard
- 2000 Series provides 17" of freeboard



Above: "2000 Series" L-shaped configuration.

The Dock Doctors are the exclusive distributors of **Connect-A-Dock products** for New England and New York. Please contact us for pricing and details.

Our innovative **Kayak Lift & Launch systems** provide a smooth transition for you and your paddle craft to and from the water. Available with built-in ladder to accommodate seawalls or permanent docks or without the ladder for docks that are only a minimal distance off the water.

▶ Watch a video of the kayak ladder lift at: www.thedockdoctors.com/ladder-lift-launch



Model KLL - 100

- Ladder Lift mounts to seawalls or permanent docks and have a lifting height of 6' (standard model) or 8' (tall model)
- Manual winch to raise and lower the platform (electric winch available for ladder models KLL-100 and KLL-400)
- Units without the ladder option offer 30" of lift height
- All models include boarding handle with built-in paddle hooks
- Sure-Step® UV resistant decking on platform
- Adjustable aluminum & vinyl bunks
- 100 lb. capacity lifts available with or without the ladder
- 400 lb. capacity lift available with ladder only



Left: Sure-Step® decking on platform. Adjustable aluminum & vinyl bunks accommodate all kayaks, canoes & paddle boards (not designed for Jet skis).

Shown Above: Model KLL-100 for crafts up to 100 lbs. Our KLL-400 model (see **B** on page 49) accommodates larger crafts such as the Hobie Mirage® Tandem.

Kayak Ladder Lift & Launch

For sites with fluctuating water

Our Kayak Ladder Lift & Launch has a lifting height of 6' or 8' and mounts to seawalls or permanent docks. Includes manual winch, boarding handle, kayak leash and adjustable aluminum & vinyl bunks.

Model	Lifting Height	Max Craft Weight	ALUMINUM
			Price
A KLL-100-6S with manual winch	6 feet	100 lbs.	\$ 2,149
A KLL-100-8T with manual winch	8 feet	100 lbs.	\$ 2,549
B KLL-400-6S with manual winch	6 feet	400 lbs.	\$ 3,149
B KLL-400-8T with manual winch	8 feet	400 lbs.	\$ 3,549

Kayak Launch: Dock Mounted

For docks that are a minimal distance off the water, our dock mounted Kayak Launch has a lifting height of 30". Includes manual winch, boarding handle, kayak leash and adjustable aluminum & vinyl bunks.

Model	Lifting Height	Max Craft Weight	ALUMINUM
			Price
C KDL-100 with manual winch	30"	100 lbs.	\$ 1,949

Concrete Mounting Installation Kit (not shown)

Includes parts for installation on concrete surface.

KLL100 Install Kit: (4) pieces of ½" threaded stainless steel rod with Epoxy tube; (4) stainless steel ½" nuts, flat & lock washers & Never-Seez®. **\$99**

KLL400 Install Kit: (4) pieces of ¾" threaded stainless steel rod with Epoxy tube; (4) stainless steel ¾" nuts, flat & lock washers & Never-Seez®. **\$109**

Note: installation will require an electric hammer drill with concrete bit sized accordingly for the rod listed above.

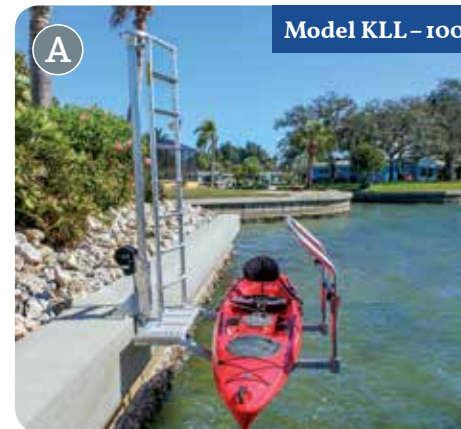

Optional Accessories



Kayak Roller: \$170

not available for use with top transition step



Top Transition Step: \$265

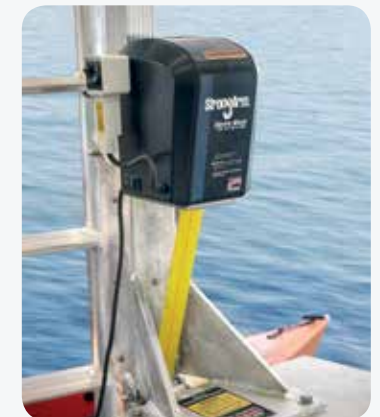

Electric Winch

A/C: \$495* D/C: \$495*

**Note: Prices are if purchased with a new lift. The price is \$575 when purchasing for an existing lift.*



Watch a video of the launch port lift at:
www.thedockdoctors.com/launch-port-lift

- A 30" handwheel easily raises & lowers the launch platform.
- B Easy-access boarding handle (optional).
- C Grab and launch rails (optional).

Launch Port Lift

- Ideal for fluctuating water
- Aluminum vertical boat lift with launch port
- Non-marring Stoltz® rollers
- Non-skid Sure-Step® platform
- 30" handwheel raises & lowers the platform
- Includes 18" adjustable legs (other lengths available)
- Stainless steel fasteners & cables

Launch Port Lift



Item	Price
Assembled	\$ 4,689
Unassembled	\$ 4,489
Boarding Handle (optional)	\$ 325
Grab and launch Rails (optional)	\$ 550



Lifting Height	75"
Overall Width	73"
Overall Length	144"
Weight with platform	400 lbs.



- Ideal for controlled bodies of water with minimal fluctuation
- Non-marring Stoltz® rollers
- Variety of layouts available by adding more leg dock sections to accommodate individual sites
- Optional grab and launch rails offer more control for gliding on and off the launch platform
- See our **Paddle Products** catalog or visit our website for more details



Easy-access boarding handle



Grab and launch rails

Freestanding Launch Port Standard Duty Aluminum

Base unit includes:

(1) 4' x 8' & (1) 4' x 10' standard duty leg dock sections and (1) 4' x 12' launch ramp.

Item	Price
Freestanding Launch Port System	\$ 4,300
Boarding handle (optional)	\$ 325
Grab & launch rails (optional)	\$ 550



Commercial Launch Systems

See pages 51 in our *CUSTOM* catalog or visit our website for more details on our commercial launch systems.



Floating Kayak Launch (shown left)

Can be used as an independent launch, as a complete floating dock system, integrated into existing systems, or in conjunction with any of our floating dock systems.

Floating "add-on"

Kayak Launch (shown right)

Ideal to add onto existing municipal or commercial floating dock systems.





PWC & Small Craft Lifts

- 1,000 lb. & 1,200 lb. capacity cantilever models
- Stainless steel hardware & cables
- Polymer pulley sheaves prolong cable life
- Dual mounting winch (left or right side)
- 15 Year Limited Warranty
- 1,250 lb. vertical & 2,000 lb. hydraulic models also available

(see Vertical Lift section on p. 55 or Hydraulic Lift section on p. 58)



Model	PL1000	PL1200	PL1200W
Capacity	1,000 lbs	1,200 lbs	1,200 lbs
Max. Beam	64"	70"	87"
Lifting Height	46"	46"	46"
Bed Length	72"	96"	96"
Min. Water Depth	9"	10"	10"
Overall Width	72"	80"	98"
Adjustable Legs	(4) @ 18"	(4) @ 18"	(4) @ 18"
Shipping Weight	155 lbs	257 lbs	316 lbs
<i>List Price</i>	\$ 1,510	\$ 2,075	\$ 2,540
Sale Price <i>(assembled)</i>	\$ 1,390	\$ 1,870	\$ 2,264
Sale Price <i>(unassembled)</i>	\$ 1,280	\$ 1,760	\$ 2,154

Safe harbor for your personal watercraft!

The **Connect-A-Port 2XL by Connect-A-Dock®** with universal hull support makes docking personal watercraft safe and easy! Simply idle up and drive on to dock and roll-off to launch.



Connect-A-Port Options

- Attachment kit for fixed & floating docks
- Connecting hardware to link multiple units (side by side)
- Bow stop winch (to help secure your PWC in rougher water conditions)

Find out more online at:

www.thedockdoctors.com/pwc-port



Model: CAPO002

157" × 58.5" × 23"

(398.8 cm × 148.6 cm × 58.4 cm)

Maximum flotation: 1700 lbs. (771 kg)

Weight: 340 lbs. (154.2 kg)

Price: \$ 1,924*

MSRP: \$ 2,138

**Price does not include attachment or connecting hardware to dock system.*

Connect-A-Port Features & Benefits

- Accommodates 1, 2, 3 and 4-place personal watercrafts
- Ultra tough, polyethylene construction
- Two keel rollers
- Four or six bow rollers
- Patented bow stop
- Cable & clip for securing PWC
- Multiple, molded-in tie down loops or handles
- Anti-skid walk area
- Universal hull support
- Front or side mounting
- 5-Year product warranty

The Dock Doctors are the exclusive distributors of **Connect-A-Dock products** for New England and New York. Please contact us for pricing and details.



- All stainless steel hardware & cables
- High lifting range
- Minimal water required
- Manufactured in New York State
- 15 year limited warranty
- Delivery & installation available



We can deliver and install your boat lift



Aluminum Vertical Boat Lifts



Model #	Weight Capacity	Max. Beam	Overall Width	Overall Length	Lifting Height [†]	Min. Water	Shipping Weight	List Price	Dock Doctors Price (assembled)	Dock Doctors Price (unassembled)
VL1250*	1,250 lbs	65"	73"	82"	75"	8.5"	233 lbs	\$ 2,520	\$ 2,375	\$ 2,165
VL20100*	2,000 lbs	100"	108"	100"	66"	9.5"	249 lbs	\$ 3,315	\$ 3,160	\$ 2,845
VL35108	3,500 lbs	108"	116"	108"	68"	8"	495 lbs	\$ 5,010	\$ 4,726	\$ 4,306
VL35108 T	3,500 lbs	108"	116"	108"	80"	8"	510 lbs	\$ 5,255	\$ 4,937	\$ 4,517
VL45108	4,500 lbs	108"	116"	116"	68"	8"	507 lbs	\$ 5,285	\$ 4,962	\$ 4,542
VL45116	4,500 lbs	116"	124"	116"	68"	8"	510 lbs	\$ 5,445	\$ 5,100	\$ 4,680
VL45116 T	4,500 lbs	116"	124"	116"	80"	8"	523 lbs	\$ 5,710	\$ 5,315	\$ 4,895
VL40124 P**	4,000 lbs	124"	132"	141"	68"	8"	445 lbs	\$ 5,630	\$ 5,350	\$ 4,825
VL50124 T	5,000 lbs	124"	133"	132"	80"	9"	597 lbs	\$ 6,185	\$ 5,718	\$ 5,298
VL60124 T	6,000 lbs	124"	133"	132"	80"	9"	663 lbs	\$ 6,480	\$ 5,974	\$ 5,499
VL70132 TP** ‡	7,000 lbs	132"	141"	138"	78"	11"	800 lbs	\$ 9,120	\$ 8,419	\$ 7,789
VL80124 T***	8,000 lbs	124"	133"	132"	78"	11"	777 lbs	\$ 9,865	\$ 8,955	\$ 8,375
VL100132***	10,000 lbs	132"	147"	158"	78"	13"	1217 lbs	\$ 15,640	\$ 14,114	\$ 13,379

All pricing is F.O.B. our facility in Ferrisburgh, VT. Prices are for in stock product only. Additional freight charges may apply for special orders. Boat lift prices include (4) adjustable 29" legs with footpads and carpeted pressure treated bunks. Manual handwheel is included with non-electric models. *Lift includes 18" legs. **Bunks not included with pontoon lift - add desired kit from kits listed at bottom of page. ‡***Lifts include AC Direct Drive with remote control and double carpeted wood bunks. 7k Pontoon lift includes AC Direct Drive w/remote control. † Measured from top of load tubes to bottom of feet when adjustable legs are fully retracted. Measurements are approximate.

Pontoon & Tritoon Cradle Kits

Lift Model	Pontoon Cradle & Guide Kit	Tritoon Cradle & Guide Kit	Pontoon Deck Kit
4000-4500	\$ 900	\$ 1,165	\$ 570
5000	\$ 995	\$ 1,290	\$ 590
6000	\$ 1,080	\$ 1,405	\$ 590
7000	\$ 1,130	\$ 1,460	n/a

Pontoon Cradle & Guide Kit



Pontoon Deck Kit



Pontoon and Tritoon cradle kits also available

A Vertical Lift Guides, Motor Stops & Extension Legs

Lift Models	Carpeted Guides		Other Options		
	regular adjusts from 16"-25 1/2" high	tall adjusts from 25"-34 1/2" high	3" Vinyl Motor Stop	Ext. Legs 4' pair	Ext. Legs 6' pair
3500	\$ 585	\$ 600	\$ 155	\$ 240	\$ 300
4500	\$ 585	\$ 600	\$ 155	\$ 240	\$ 300
5000	\$ 620	\$ 625	\$ 155	\$ 240	\$ 300
6000	\$ 625	\$ 630	\$ 180	\$ 240	\$ 300
8000	n/a	\$ 660	\$ 190	\$ 240	\$ 300
10,000	n/a	\$ 965*	\$ 190	\$ 310	\$ 350

*Tall guides for 10,000 lb. boat lift adjust 25" – 43 1/2". Credits available with the purchase of a new boat lift: Credit \$95 for a pair of 29" legs if upgrading to longer extension legs with the purchase of a new boat lift.

Electric Drive Units

Lift Models	AC Drive Systems				DC Drive Systems			
	Direct	Direct with remote	Extreme Max Manual	Extreme Max with remote	Direct	Direct with remote	Extreme Max Manual	Extreme Max with remote
3500	\$ 1,655	\$ 2,410	\$ 1,100	\$ 1,415	\$ 2,300	\$ 2,555	\$ 1,100	\$ 1,415
4500-5000	\$ 1,700	\$ 2,515	\$ 1,100	\$ 1,415	\$ 2,300	\$ 2,555	\$ 1,100	\$ 1,415
6000	\$ 1,675	\$ 2,515	\$ 1,100	\$ 1,415	\$ 2,220	\$ 2,565	\$ 1,100	\$ 1,415

Note: Drives listed are for lifts with R18 winches only. Please inquire for pricing and information on electric drives for D&L winches. Credit \$175 for handwheel with the purchase of a direct drive and a new boat lift.

- B Direct Drive** This direct drive uses an industrial oil bath gear reducer and motor with a stainless steel cover which connects to the standard winch. Available with a remote control option. Available as an AC or DC unit.
- C Extreme Max Drive System** Manual key or optional remote control operation with a backup bit for manual operation of the unit in the event of a power outage. Comes complete with mounting kit.
- D VL Solar Power Box** Portable solar power source for waterfront owners with no electricity. Lightweight white fiberglass box holds (2) deep cycle batteries with a power source on/off switch. Available as solar or with an A/C trickle charger. **Solar charged: \$ 1,319 A/C charged: \$ 1,269**



Shown with optional aluminum & carpeted guides & guide rollers



Direct A/C drive with manual switch



Extreme Max D/C drive with remote control and solar power box.



Above: "Cadet Grey" canopy.

Right: "Pacific Blue" canopy.



Sunbrella® Boat Lift Canopies

Lift Models	Description	(unassembled) Price
20100	18' × 100"	\$ 2,635
20100	21' × 100"	\$ 2,935
35108/45108	21' × 108"	\$ 3,095
35108/45108	24' × 108"	\$ 3,225
45116	24' × 116"	\$ 3,315
45116	26' × 116"	\$ 3,490
45116	28' × 116"	\$ 3,855
45116	30' × 116"	\$ 4,010
40124/50124/60124/80124	24' × 124"	\$ 3,430
40124/50124/60124/80124	26' × 124"	\$ 3,600
40124/50124/60124/80124	28' × 124"	\$ 3,915
40124/50124/60124/80124	30' × 124"	\$ 4,020
100132	32' × 132"	\$ 4,365
100132	36' × 132"	\$ 4,770

Prices include aluminum canopy frame & fabric in standard colors (Pacific Blue, Cadet Grey & Forest Green). Signature colors available as a special order at an additional cost. Additional costs for shipping may apply for canopies not in stock.

Boat Lift Installation & Removal Tools

Make the seasonal installation and removal of your boat lift easier with a wheel kit and/or air bag lift system.

A Boat Lift Wheel Kits

Specifically designed for use with RGC® boat lifts and can be modified for use with hydraulic boat lifts. Includes a pair of welded galvanized steel mounting brackets and (2) heavy duty polyethylene wheels.

BLW2045 (fits 2,000 - 4,500 lb. lifts): \$ 305 / pair

BLW5060 (fits 5,000 - 6,000 lb. lifts): \$ 320 / pair



B Air Bag Lift Kits

Inflatable 250 and 500 lb. capacity air bags with attachment strap to float your boat lift for seasonal installation and removal. Ideal when used in conjunction with a wheel kit (see photo on left). Includes connecting kit (carabiner and strap).

250 lb. capacity: \$ 245

500 lb. capacity: \$ 365



- Available from 2,000 to 12,000 lb. capacity
- Stainless steel hardware
- Aluminum hydraulic cylinders
- Full length vinyl bunks
- Solar or AC charging options
- Manufactured in New York State
- 15 year limited warranty



Hydraulic Aluminum Lifts

Model #	Weight Capacity	Max. Beam	Lifting Height†	Min. Bunk Height	Shipping Weight	Lifting Speed UP (seconds)	Lifting Speed DOWN	Hydraulic Cylinders	List Price	(assembled) Dock Doctors Price	(unassembled) Dock Doctors Price
HL20065	2,000 lbs.	65"	48"	24"	235 lbs.	30 sec	20 sec	1	\$ 5,747	\$ 5,348	\$ 5,083
HL40120XL	4,000 lbs.	120"	60"	26"	542 lbs.	65 sec	45 sec	2	\$ 8,667	\$ 7,921	\$ 7,656
HL50120XL	5,000 lbs.	120"	60"	28.5"	680 lbs.	45 sec	45 sec	2	\$ 9,412	\$ 8,564	\$ 8,299
HL70120XL	7,000 lbs.	120"	60"	30"	760 lbs.	90 sec	50 sec	2	\$ 10,517	\$ 9,490	\$ 9,225
HL90120XL	9,000 lbs.	120"	60"	31"	997 lbs.	110 sec	75 sec	4	\$ 14,199	\$ 12,464	\$ 12,199
HL120132XL	12,000 lbs.	132"	60"	40"	1,500 lbs.	80 sec	90 sec	4	\$ 20,124	\$ 17,519	\$ 17,149

*Prices above include (4) 3' legs, battery, AC charger & remote control. For solar power upgrade add \$120 or \$150 for 9k & 12k models. All pricing is F.O.B. our facility in Ferrisburgh, Vermont. Prices are for in stock product only. Additional freight charges may apply for special orders. See page 3 for delivery information.

† Measured from top of bunks to bottom of feet when adjustable legs are fully retracted. Measurements are approximate.

Hydraulic Lift Accessories

Stainless Steel Fitting Upgrades

Cylinders & Hose Assemblies

Lift Model	Upgrade when purchasing new boat lift	Stainless Steel Extension Hoses	
		12'	20'
HL 4K - 6K	\$ 575	\$ 410	\$ 475
HL 7K	\$ 620	\$ 410	\$ 475
HL 9K	\$ 1,595	\$ 410	\$ 475
HL 12K	\$ 3,295	\$ 410	\$ 475

Elevated Power Box Stand

This stand provides protection for your power box from heavy wave action or high water. Aluminum frame provides 15" of height above the deck surface. **\$ 245**

Power box not included in price.



HL Boat Lift Accessories: Guides, Extension Hoses and Extension Legs

Lift Model	Aluminum & Vinyl Guides	Aluminum & Wood Guides	Aluminum Rollers* (for guides)	Standard Ext. Hose 4½' pair	Standard Ext. Hose 12' pair	Standard Ext. Hose 20' pair	Ext. Legs 5' pair	Ext. Legs 7' pair w/ bracing	Ext. Legs 9' pair w/ bracing
3000-4000	\$ 1,150	\$ 1,130	\$ 110	\$ 120	\$ 170	\$ 225	\$ 245	\$ 790	\$ 920
5000-7000	\$ 1,180	\$ 1,175	\$ 110	\$ 120	\$ 170	\$ 225	\$ 245	\$ 790	\$ 920
9000	\$ 1,220	\$ 1,210	\$ 110	\$ 120	\$ 170	\$ 225	\$ 245	\$ 790	\$ 920
12,000	\$ 2,885	n/a	\$ 110	\$ 120	\$ 170	\$ 225	\$ 245	\$ 930	\$ 1,045

* The aluminum rollers are a recommended option for the aluminum guides. Credit \$160 for 3' legs if upgrading to longer extension legs with the purchase of a new boat lift.



HL Canopies



Size	Price
24' x 124" Canopy	\$ 3,300
26' x 124" Canopy	\$ 3,470
28' x 124" Canopy	\$ 3,785

Note: Prices include standard color Sunbrella® Fabric (Pacific Blue, Cadet Grey & Forest Green). Optional and signature colors are available as a special order (additional cost).

Canopy Leg Kits

Size	Price
4' Canopy Leg Kit with 8' posts	\$ 955
6' Canopy Leg Kit with 8' posts	\$ 1,095
8' Canopy Leg Kit with 8' posts	\$ 1,315

All pricing is F.O.B. our facility in Ferrisburgh, VT. Prices are for in stock product only. Additional freight charges may apply for special orders.



Ideal for boats from 6,000 to 32,000 lbs, our *Ultimate Vertical Boat Lifts* are custom manufactured with industrial quality hot-dipped galvanized steel. This lift can be used in shallow and deep water applications, rough water, and in fluctuating water levels. The 12,000 lb. and larger models are modular for ease of seasonal handling.

Now offering new, aluminum hydraulic boatlifts with capacities up to 24,000 lbs.



Ultimate VL Boat Lift – by *The Dock Doctors*

- Vertical lifts from 6,000 lb. to 32,000 lb. capacity
- 9 ft. standard lift height (other heights available)
- Great for shallow or deep water applications
- Adaptable to boathouses for use with permanent docks
- High lift for rough water & fluctuating water levels
- Portable/seasonal if necessary
12,000 lb. & larger models fabricated in modular sections for ease of seasonal handling
- Industrial quality hot dipped galvanized steel construction, stainless steel cables & galvanized fasteners
- Custom heights, widths & lengths are available to accommodate your boat & location



Above: 32,000 lb. capacity Ultimate Boatlift.

Right: Modular section of the boatlift shown above, being loaded for delivery.





We can deliver and install your boat lift
see page 3 for delivery information

Now offering heavy duty aluminum hydraulic boatlifts up to 24,000 lb. capacity.

Please contact us for more information and pricing.

NEW PRODUCT



Dock Doctors® Ultimate Vertical Boat Lifts



Model #	Capacity	# of Drives	Maximum Beam	Lifting Height	Overall Width	Overall Length	Price*
6000	6,000 lbs.	2	8' 6"	9'	11'	12'	\$ 13,500
9000	9,000 lbs.	2	10'	9'	12'	13'	\$ 15,225
12000	12,000 lbs.	4	11'	9'	13'	14'	\$ 22,575
18000	18,000 lbs.	4	12'	9'	14'	16'	\$ 26,145
24000	24,000 lbs.	4	14'	9'	16'	18'	\$ 30,975
32000	32,000 lbs.	4	18'	9'	20'	20'	\$ 35,595
Auto Stop System (recommended option)							\$ 935

Custom sizes are available.

*Prices above include Gem remote control, sealed bearing and grooved cable winders, AC drives, (4) 7' vertical guide poles with PVC sleeves, (4) wheel mounts, (4) 24" adjustable legs and heavy duty carpeted bunks. Optional oil bath drives and full length guide-ons are available. Please inquire for pricing.

Sliding Boarding Step \$889

Bridges the gap from your dock to your boat



Remove the gap to transition safely to/from your boat. Securely attaches to your existing dock. Find out more at: www.thedockdoctors.com/boardingstep



Queensbury, NY

12,000 lb. capacity Ultimate Lift with oil bath drive upgrade.



Shelburne, VT

12,000 lb. Ultimate vertical boat lift with custom canopy.

See pages 28–29 in our CUSTOM catalog or visit our website for more details on our Custom Boat Lifts.

Boathouse Lifts are custom built to be installed in new or existing boathouses. These lifts are designed to accommodate various boat styles, capacities, and in some cases, aesthetic appearance.

- Freestanding units for boathouses without structural integrity to support your boat
- Bunk style cradle system with pull-out tubes for winter storage
- Sling style for shallow water applications



Occasionally, protecting your boat requires a product that is designed to fit your individual needs. We can design, fabricate, and install custom canopies, boat lifts and much more to accommodate unique situations. Please contact us for a free estimate and conceptual layout.



Above: The Dock Doctors Ultimate Lift (see pages 60–63) customized to attach to the shore with galvanized lift arms which allow it to be raised for winter storage.



Lake Placid, NY

Custom powder coated uprights for use with a standard RGC® canopy.

Installation & Removal Service

Let the Waterfront Specialists do it for you!
We provide service to all areas in the Northeast!

*Living in the Northeast often has the added responsibility of removing and installing your dock system every year. Take the worry and hassle away with **The Dock Doctors® seasonal service plan**, and have the assurance that your system will be taken care of with the utmost quality and safety in mind.*



Our portable workboats from 25'-32' in length allow us to provide installation for our products throughout the Northeast.





Vermont Showroom & Manufacturing Facility

Visit our showrooms

Take a virtual tour of our facility at: www.thedockdoctors.com/tour

Vermont Showroom & Manufacturing Facility

19 Little Otter Lane, Route 7, Ferrisburgh, VT 05456

800-870-6756

info@thedockdoctors.com

**OPEN
YEAR-ROUND!**

Monday-Friday 9:00-4:30

Saturday 9:00-1:00 (April 7th thru July 28th)

Showroom closed Memorial Day Weekend and 4th of July



Lake Placid/Saranac Showroom

876 State Route 86, Ray Brook, NY

518-354-5011 (seasonal phone only)

info@thedockdoctors.com

Seasonal Hours (June 2nd through September 8th)

Tuesday-Friday 10am-4:30pm Saturday 10am-2pm

Showroom closed Memorial Day Weekend and 4th of July



Lake George Product Display

No Staff - No Hours - Come by anytime

2963 Lake Shore Drive (Rte 9N), Lake George, NY

Just off Exit 22 of the Adirondack Thruway



2018 STOCK