

The Dock Doctors[®] LLC

Waterfront Specialists



2017 STOCK CATALOG *Readily Available for*



*see page 3
for details*

■ Docks & Accessories

■ Boat Lifts

■ Aluminum Stairs

The Dock Doctors[®] Waterfront Specialists



Design Whether your project is complex or straight-forward, our sales and design team will evaluate your individual site and discuss your waterfront needs. *We offer in-house and on-site consulting, conceptual layouts, and designs.*

Factory Direct... From Our Door to Yours!

Founded in 1984, we have over 30 years experience and have installed thousands of docks throughout the entire Northeast. Our extensive range of knowledge and expertise allows us to offer a very diverse - and often innovative - product line to meet the challenges of site conditions and unique situations.



Manufacture All of our products are manufactured in our state-of-the-art facility in Ferrisburgh, Vermont. We offer both readily available stock products as well as custom (see separate custom catalog) designs for your specific needs. We strive to source all of our raw materials from within North America.

Start planning your waterfront project today!

800-870-6756
www.thedockdoctors.com

Take a virtual tour of our facility at:

www.thedockdoctors.com/tour



Install We have the equipment, knowledge and experienced staff to ensure a smooth and quality installation. We also offer seasonal installation and removal services throughout the entire Northeast

- Work barges with hydraulic cranes.
- Fleet of service vehicles that cover the Northeast region.

We serve the entire Northeast



Westchester County NY
Lic# WC-25057-H12

Connecticut • Massachusetts • Maine • New Hampshire • New Jersey • New York • Vermont

Designing the perfect waterfront

Let us assist you with creating the ideal dock system for your individual needs and specific site conditions!

This FREE service provides the benefit of our expert staff in developing your waterfront design.

Please call us today at **1(800) 870-6756** to start planning your project – or complete our **site survey** online to get started today!



➔ Fill the survey out online at: www.thedockdoctors.com/site-survey

View our other catalogs

Download any of our catalogs online at: www.thedockdoctors.com/catalogs or call us at 1-800-870-6756 to have one mailed to you today.



CUSTOM CATALOG

- Custom Docks
- Marine Construction
- Custom Stairs & Waterfront Access
- Hillside Trolleys
- Commercial & Municipal Dock Systems
- Marine & Specialty Contractors
- Boat Houses



PADDLE PRODUCTS

- Storage Racks for kayaks/canoes
- Paddlesport Trailers & Accessories
- Trailers with multi-craft racks
- Beach Dollies & Beach Roller Racks
- Kayak Ladder Lift & Launch
- Paddle & Rowing Docks
- Dock & Launch Systems



DOCKS
Stock Docks & Accessories



LAUNCH
Systems & Rowing Docks



STAIRS
& Waterfront Access



BOAT LIFTS
& Boat lift Canopies

STOCK DOCKS & ACCESSORIES

Stocked and available for pickup, delivery or installation

- Swim Floats 4-5
- Pond Docks 6-7
- Dock Options, Accessories 8-19
- Leg & Wheel Docks 20-37
- Aluminum Floating Docks 38-40
- Aluminum Gangways 41

ALUMINUM STAIRS

Aluminum stair systems with adjustable rise and run

- Adjustable Aluminum Stairs 42-43

DOCK & LAUNCH / ROWING DOCKS

Launch systems and rowing docks

- Paddle & Rowing Docks 44-47
- Dock & Launch Systems 48-49
- Kayak Ladder Lift & Launch 50-51
- Launch Port Lift 52

BOAT LIFTS & ACCESSORIES

Protect your boat and your dock with a boat lift

- PWC & Small Craft Lifts 53
- Vertical Boat Lifts & Accessories 54-57
- Hydraulic Boat Lifts & Accessories 58-59
- Ultimate Vertical Boat Lifts 60-63
- Boathouse & Specialty Lifts 64
- Custom Canopies 64

Free Curbside Delivery

Look for the truck for our stock products that qualify for free delivery*!



Minimum Purchase Amount <i>(not including sales tax)</i>	Free Delivery from Ferrisburgh, VT <i>(Distance based on Google Maps)</i>	Delivery Charge <i>(one-way)</i> <i>(over the free mile range)</i>
\$ 1,000	25 miles	\$2 /mile
\$ 2,000	50 miles	\$2 /mile
\$ 4,000	100 miles	\$2 /mile
\$ 6,000	150 miles	\$2 /mile
\$ 8,000	200 miles	\$2 /mile
\$10,000	250 miles	\$2 /mile

* Free Curbside Delivery Terms & Conditions:

1. Curbside delivery definition: We will back up as close as we can with our vehicle to your installation site and off-load your product. We cannot carry your product further than the side/rear of our truck/trailer.
2. Free delivery available on The Dock Doctors® Stock Products only. Please see chart to the left for minimum purchase amounts to qualify for free delivery. Free delivery does not apply to rowing or paddle docks.
3. RGC® Boat Lifts, canopies, accessories - free delivery applies to products in stock only.
4. If you want your product installed, please inquire on rates for this service - free delivery does not apply.
5. Additional fees apply for wide loads (assembled boat lifts) and ferry charges, if needed.
6. Purchases under \$1000 are subject to a \$2 per mile one way charge from Ferrisburgh, VT. A ground shipping method/charge by another source such as Common Carrier or UPS may be more feasible depending on product purchased.



A Steel Swim Float

Heavy Duty Galvanized Steel Swim Float

- Two-piece galvanized steel frame
- Optional powder coated frame
- Includes 3' aluminum ladder
- Removable cedar or NyloDeck® composite decking panels



heavy duty galvanized steel swim float dismantles into two pieces for ease of handling

A Heavy Duty Galvanized Steel Swim Float (shown above)

Ideal for rough water. Dismantles into two pieces for ease of handling. Includes 3' aluminum ladder and polyethylene floats. **Available with cedar or NyloDeck® composite decking** (see decking details on p. 15).

Stock Size	Weight*	Net Buoyancy	CEGAR	NYLODECK®	Powder Coated Frame Upgrade
			Price	Price	
8' x 8'	226 lbs.	884 lbs.	\$ 1,699	\$ 2,315	+ \$ 529
8' x 10'	235 lbs.	850 lbs.	\$ 1,875	\$ 2,649	+ \$ 549
10' x 10'	437 lbs.	1963 lbs.	\$ 2,479	\$ 3,445	+ \$ 579

*Weight is with decking removed.

Please allow additional order time for powder coated upgrade.

Swim Float Anchors

Light Duty Swim Float Anchor Kit: \$149
includes light duty anchor block (18" x 8", 180 lbs), shackles, swivel, 3' of 3/8" chain & (2) 10' nylon ropes
Nylon extension of rope: 14' (\$10), 18' (\$13), 22' (\$16)



Heavy Duty Concrete Anchor: \$125
2' x 2' x 8", 400 lbs



Heavy Duty Float Anchor Harness: \$145
includes shackles, swivel & (2) nylon ropes



3/8" Galvanized Chain: \$4.⁵⁰ per foot
(amount of chain needed is 1.5 x the water depth)



B Aluminum Swim Float

Aluminum Swim Float

- Lightweight aluminum frame
- Optional powder coated frame
- Includes 3' aluminum ladder
- Removable cedar decking panels

(Aluminum, NyloDeck® composite & Sure-Step® also available)



C 8' x 8' Aluminum Swim Float with Sure-Step® decking

Includes flow thru Sure-Step® decking attached directly to the frame (not removable). Includes 3' aluminum ladder.



brown green black
Powder Coated Frame

Powder Coated Swim Float

Optional powder coating for your swim float and ladder. Available on all our swim floats. Please allow for additional order time.

B & **C** Aluminum Swim Float (shown above)



Ideal for use in small lakes or bays. One piece lightweight aluminum frame with polyethylene floats. Includes 3' aluminum ladder. Available with cedar, aluminum, Sure-Step® or NyloDeck® composite decking.

see decking details on p. 15

Stock Size	Weight*	Net Buoyancy	CEDAR	ALUMINUM	SURE-STEP®	NYLODECK®	Powder Coated Frame Upgrade
			Price	Price	Price	Price	
8' x 8'	155 lbs.	960 lbs.	\$ 1,629	\$ 2,039	n/a	\$ 2,249	+ \$ 529
8' x 8'	284 lbs.	982 lbs.	n/a	n/a	\$ 1,939	n/a	+ \$ 529

*Weight is with decking removed - with the exception of (C). Sure-Step® decking (C) attaches directly to the dock frame and is not removable. Cedar, NyloDeck® & Aluminum decking is manufactured in removable panels.

Please allow additional order time for powder coated upgrade.

- 4' × 16' and 4' × 20' (custom sizes also available)
- Removable cedar or NyloDeck® composite panels
- Galvanized steel frame, polyethylene floats
- Optional powder coated frame
- Includes (2) 3 ft. long 1 ½" pipes



B 4' × 20' Pond Dock

4' x 20' pond dock with brown powder coated upgrade



A 4' x 16' pond dock

Pond Docks

Features a galvanized steel frame, removable decking panels and black polyethylene floats.

see decking details on p. 15



CEDAR

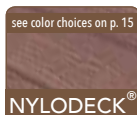

NYLODECK®



Powder Coated Frame

Stock Size	Weight*	Price	Price	Upgrade
A 4' x 16'	370 lbs	\$ 2,039	\$ 2,849	+ \$ 659
B 4' x 20'	450 lbs	\$ 2,725	\$ 3,849	+ \$ 769

*Weight is with decking removed. Custom sizes and decking available. Please call for details.

Dock Ladders (sold separately)

One-piece, removable vertical ladder with 1 1/2" tubular aluminum frame and arched, slip resistant 4" treads for added comfort with bare feet.



other colors available upon request

Stock Size	C aluminum	D special order powder coated
3' ladder	\$ 219	\$ 339
4' ladder	\$ 239	\$ 365
5' ladder	\$ 259	\$ 389

Please allow additional order time for powder coated ladders.

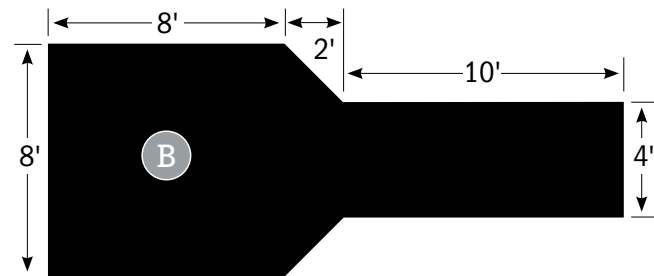
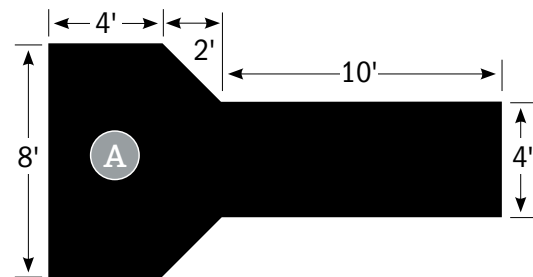

A Dock Ladders *(available for all dock systems)*

One-piece, removable vertical ladder with 1 1/2" tubular aluminum frame and arched, slip resistant 4" treads for added comfort with bare feet.



Ladder Size	Aluminum	Powder Coated
3' ladder	\$ 219	\$ 339
4' ladder	\$ 239	\$ 365
5' ladder	\$ 259	\$ 389

Please allow additional order time for powder coated ladders.



Dock Ladder
(aluminum finish)

Please note any dock compatibility exclusion(s) for options and accessories. Please be sure to identify your style of dock when placing orders for options.

B Shallow Water Stairs *(available for all leg & wheel docks)*

One-piece welded aluminum structure with aluminum handrails down each side and non-slip treads with adjustable footpads.



Stair Size	Aluminum	Powder Coated	Elevation ¹
4 step	\$ 575	\$ 749	37" – 49"
5 step	\$ 625	\$ 819	45" – 57"
6 step	\$ 675	\$ 889	53" – 65"

Please allow additional order time for powder coated stairs.

¹ Accommodates elevation from deck surface to lake bed.



Shallow
Water Stairs

shown above with optional powder coated finish (special order)

NEW PRODUCTS

Lower Access Platform for swimming & kayaking

Stationary leg docks are often quite a distance above the water's surface, making accessing the water for swimming or kayaking very difficult. This lower access platform is designed to provide you with a safe transition to the water. If the distance is too far to step from your dock to the platform, utilize one of our aluminum ladders on the dock to safely transition to the lower platform.

- Designed to provide lower access for swimming or using your paddle crafts
- Add our aluminum ladder (see page 8) on your dock to transition down to the platform if needed
- Overall frame size is 15" wide × 9' 3" long (designed to be used alongside any 8–10' long dock with 1 ½" support pipes).
- 5" tall aluminum frame with Sure-Step® flow-thru, anti-slip decking
- Adjustable sleeves that slide over 1 ½" support pipes

Lower Access Platform: \$695

Disclaimer: To avoid tipping, the dockside platform must be installed on a leg dock system rather than a single dock as shown. Please contact us for more details.



Boarding Handle

Made with marine-grade aluminum, the boarding handle provides a safe handhold when boarding your boat. Mounts available for any **Dock Doctors** dock systems or a universal mount to attach to any dock frame. Height from mount to top of handle is 48".

Boarding Handle: \$ 89

Track Mount (as shown): \$ 59

please call for pricing on other mount styles.



Angled Ladder NEW

One-piece welded aluminum angled ladder with aluminum non-slip treads.

Please Note: the photo is our prototype. Please call or check our website for more information on availability, sizes and pricing.





Shipping Available

Protect your boat and dock with our adjustable vertical fenders

(available for all dock systems)

Our unique vertical fender design is adjustable on the mount which is often necessary due to lake level and boat style. Add a fender cleat kit (see **G** below right) for a complete securing system for your boat.



Our pipe-mounted vertical fenders offer two forms of adjustment. They adjust up and down on the mount and up and down on the pipe.

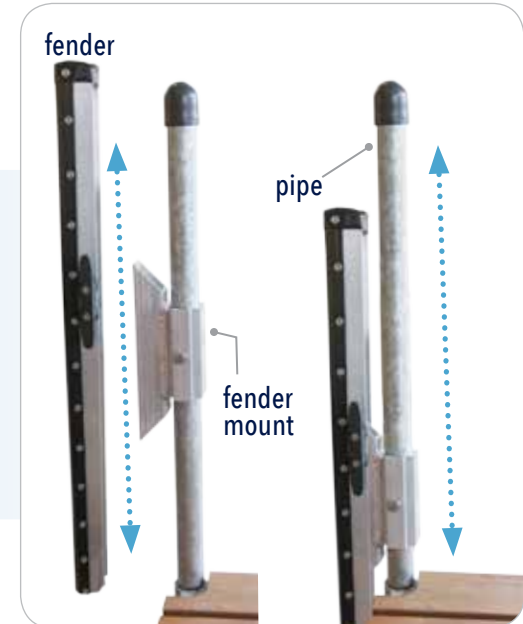

Vertical Fenders				
Fender Style	Mounting Style	3' long	4' long	
<i>For all Aluminum Leg & Wheel Docks & Steel Truss Leg Docks with 1 1/2" pipe:</i>				
A Fender	1 1/2" pipe mount	\$ 134	\$ 156	
B Double Corner Fender	1 1/2" pipe mount	\$ 241	\$ 286	
<i>For all Steel Truss Wheel Docks with 1 1/2" pipe:</i>				
C Fender with offset	1 1/2" pipe mount	\$ 145	\$ 167	
<i>For all Mega Leg Docks with 3" pipe or Custom Articulating Docks with 2" pipe:</i>				
D Fender	2" or 3" pipe mount	\$ 165	\$ 187	
<i>For all Aluminum "Track-Frame" Floating Docks:</i>				
E Fender (shown on p. 37)	Track Mounted	\$ 145	\$ 167	
<i>For all Aluminum "Track-Frame" Floating Docks - includes spud mount:</i>				
F Fender (shown on p. 37)	Spud Anchor Mounted	\$ 315	\$ 338	



G Fender Cleat Kit

Designed to be used with the 3' or 4' fenders listed to the left. Includes (2) cleats per kit that bolt onto the fender mount.

\$ 36.⁹⁵ / kit

Fender Cleat Kit
2 cleats included per kit



A Edge Fender

High quality, non-marring black edge fender. Available for all aluminum "track-frame" floating docks, and custom galvanized steel floating dock systems.

\$ 6.⁵⁰ per foot (material only, not installed, not including fasteners)

\$ 9.⁷⁵ per foot (installed with stainless steel fasteners*)

*installation available on new dock orders only

Cleats

B Pipe Cleat (for 1 1/2" pipe)

A single cleat mounted to a sleeve that slides over the leg pipe. Available for all leg & wheel docks except the mega leg & wheel docks. \$ 29.⁷⁹ each

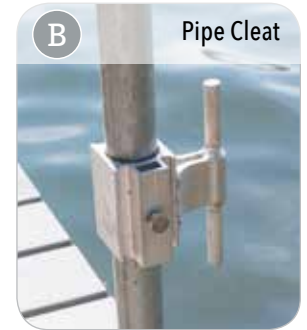

C Track Cleat

Designed to slide along the track of our floating aluminum track dock systems (see pp 38-40). \$ 18.⁹⁹ each

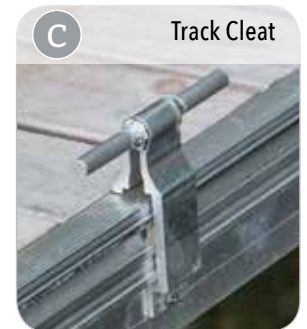

D Taylor Made Mooring Whips

Mooring whips with fixed angle base. Two-piece kit, will need to be epoxied (epoxy included with kit). **Recommended for low profile boats such as bass boats, runabouts and sport boats.**

MW120: \$ 521

MW140: \$ 591

(for 18' - 23' boats / 2,500-5,000 lbs.)

(for 24' - 28' boats / 5,000-10,000 lbs.)

Disclaimer: Some docking conditions may be too rugged for this product.

E Dock Doctors Mooring Whip Dock Mounts

Required for docks with removable decking. \$ 129

for Taylor Made mooring whip models listed above only



Truss frame mount



Track frame mount

Sliding Boarding Step

Dock mounted sliding boat boarding step that bridges the gap between your dock and your boat.

- Boarding Step travels 20" depending on mounting location
- Smooth operation slides back & forth
- Includes safety handrail that can mount to either side of platform
- Sure-Step® slip resistant polypropylene decking
- Welded aluminum 5" high frame with mounting bracket
- Vinyl edge fender to protect boat
- Securely attaches to your existing dock - not a free-standing unit
- Weight capacity of unit is 300 lbs. (Note: dock structure & condition will affect capacity of unit)



Ideal for pets too!



Shipping Available

Sliding Boarding Step

Style	Price
Sliding Boarding Step	\$ 849

Prices include boarding handle. Platform is a welded, one-piece unit. Mounting to dock system may require additional reinforcement to dock for secure attachment.

NEW PRODUCT Boarding Ramp

This product is designed to create a smooth transition over the space between your dock and the swim platform on your boat. Simply flip back over onto dock when not being used or lift out of bracket to stow out of the way. Features aluminum frame with Sure-Step® anti-slip decking and vinyl strip on the underside where it rests on the swim platform.

Please note: the photos are our prototype - please call or check our website for more information on availability, sizes and pricing.



Left: Boarding ramp in boarding position.

Above: Boarding ramp in storage position.



A

Dock Mounted Roller

A single 12" keel roller designed to assist you when moving canoes, kayaks, or other small crafts on or off the dock. \$ 105



universal mount
mounts to dock
frame or decking



track frame mount
for aluminum floating
docks shown on p. 38-40



B

Single Craft Storage Arms

(dock mounted)

A pair of small craft storage arms featuring vinyl hull guards, and end caps with built in tie-down openings. Available in Universal Pipe Mount (fits all docks with 1 1/2" pipe).

\$ 157

STANDARD ALUMINUM

\$ 185

POWDER COATED BLACK



C

2-Craft Storage Rack (dock mounted)

Our *dock mounted* small-craft storage racks mount to the frame of your dock to store kayakers, canoes, stand-up paddle boards, and other small crafts.

\$ 469

STANDARD ALUMINUM

\$ 625

POWDER COATED BLACK

Note: Fits Dock Doctors Steel Truss & Aluminum Track floating dock systems, as well as a Universal Mount for wood dock systems.

Please identify what style of dock this will be mounting to when ordering.



D

6-Craft Freestanding Storage Rack

Marine-grade aluminum frame *freestanding* storage rack with adjustable height arms. Arms feature vinyl hull guards and end caps with built in tie-down openings. Available in aluminum or powder-coated black finish.

\$ 839

STANDARD ALUMINUM

\$ 1,119

POWDER COATED BLACK

See more styles in our
[Paddle Products catalog](#)
or on our website



Wall-mounted & commercial racks also available.
Please see our website or our [Paddle Products catalog](#).



Shipping Available

A Post Covers

Post covers camouflage the 1½" leg pipe for a more rustic appearance. Available in either Cedar or Trex® composite material.

Style	Cedar*	Trex**
Post Cover	\$ 209	\$ 209
Post Cover with 4' bumper	\$ 312	\$ 312
Post Cover with 4' bumper & cleats shown with pyramid style cap with built in light	\$ 359	\$ 359

*Includes stamped copper pyramid style cap. **Includes matching Trex® pyramid or flat top style cap. †Trex® colors available: Black, Gravel Path, Rope Swing, Tree House, Vintage Lantern & Fire Pit.

B Cedar Post Cover Caps

Cast aluminum powder coated finish – available in black or other colors available as an option. *Note: black caps listed below are not available for Trex® post covers.*

Style	Black
B1 Pyramid Style Cap	\$ 57
B2 Pyramid Style Cap with built in 110 volt light and ribbed glass	\$ 112
B3 Flat Top Style Cap (not shown) with built in 110 volt light and ribbed glass	\$ 112

Cedar Post Cover



Trex® Post Cover



Cedar Post Cover
with 4' bumper & cleat



shown with (B2) pyramid style cap with light

B1 pyramid style cap



B2 pyramid style cap
with built in 110v light



*Note: Light kits do not include wiring. Both 12 volt & 110 volt are available.



C

C Skirt Boards

Used to camouflage the truss frame to give the appearance of a wooden dock system. *Please inquire for further details.*

skirt boards

Skirt boards for our galvanized steel truss dock systems provide the aesthetic appearance of a wooden dock.

D Flag Poles

Add beauty to your waterfront property with a telescoping flagpole. These poles have no ropes, chains or pulleys so you do not have to worry about knots and tangles and they are virtually noise-free.



Each section of the pole raises and lowers easily. 16' tall telescoping aluminum flagpole includes a 3" gold aluminum ball ornament, a double flag harness to fly two flags or fly at half mast, a 3' x 5' nylon USA flag with embroidered stars and sewn stripes. *Other pole heights available as special order.*

Flag Poles

Style	Suggested Retail	Our Price
D1 Silver Finish Flag Pole	\$ 339	\$ 279
D2 Black Finish Flag Pole	\$ 369	\$ 299
Dock Mounts		Price
D3 Deck surface mount		\$ 80
D4 Side mount		\$ 80
D5 Pole mount for docks with 1 ½" leg pipe		\$ 80

Decking Choices

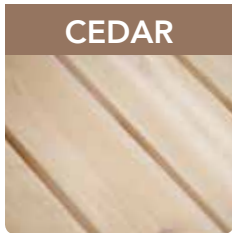

CEDAR

CEDAR Natural, cost effective decking option that is naturally resistant to decay and insects. Red cedar will weather to a soft, silvery gray. Cons: Over time will absorb moisture and weather unless sealed with a preserving stain.



ALUMINUM

ALUMINUM Powder-coated finish eliminates glare from the aluminum. Resists the growth of mold and mildew and won't rust, rot, split or stain. Non-slip, rigid, surface that is low-maintenance and is cool to the touch. Cons: Can sound metallic when you walk on it – especially on our docks with removable panels.



NYLODECK®

NYLODECK® Environmentally-friendly NyloDeck® is made using 100% recycled carpet fiber and contains no wood or PVC. NyloDeck® is the only 1 inch composite deck board rated to span joists at 24 inches on center. It is twice as strong as other leading composite decking materials. Lightweight and easy to work with and is impervious to moisture, mold, mildew and insects. Cons: Not a natural wood.

NyloDeck® color choices

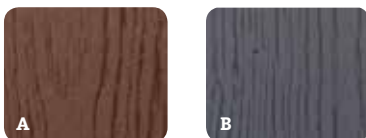

(A) Mountain Mocha, (B) Harbor Gray

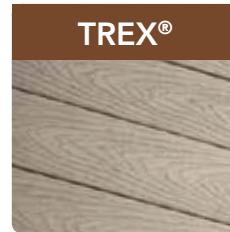

TREX®

TREX® Extremely weather resistant, Trex® is the leader in the industry for composite decking and will maintain its color and beauty for years. Recommended for direct screwed applications, 16" on center. Cons: The heaviest of all of our decking options. Due to weight, tends to hold the most heat on hot summer days. Trex® may have a sagging/wavy appearance over time.

BY SPECIAL ORDER ONLY

Trex® Standard color choices



Readily available: (A) Gravel Path, (B) Rope Swing, (C) Fire Pit
Longer lead times: (D) Vintage Lantern, (E) Tree House

Trex® Transcends premium colors



(F) Spiced Rum, (G) Lava Rock, (H) Tiki Torch



IPE

IPE Extremely hard, very durable and naturally resistant to rot and insects. Ipe's strong, resilient properties make it an excellent material choice for marine applications. Cons: It is a natural wood, therefore there will be inconsistencies with regard to color, weathering and texture. Due to the density of Ipe, it is heavy and hard to drill and cut, therefore more labor intensive than working with other decking materials.



SURE-STEP®

SURE-STEP® Slip-resistant, polypropylene surface that allows water and sunlight through to help conserve the underwater ecosystem. Preferred option for dock structures that are situated close to the water so waves will pass through the decking, adding minimal resistance. (Available on our aluminum docks and swim floats). Cons: Only available in certain dimensions, so may not be a viable option for many applications.



Shipping Available



Easy Hassle Free Mounting
No Wiring Required

Solar Dock Post Lites



\$ 55.⁹⁵
package of 2

- Fits standard pipes (1 1/2" & 2" ID in size)
- 6" H x 3.5" diameter (UV stabilized polycarbonate)
- (1) Super bright LED (12 Lumens)
- Automatic night activation
- Fully sealed electronic circuit board
- Powerful solar panel
- Lasts 18+ hours on a full charge
- Replaceable 1.2v NiMh battery
- Two (2) post lites in each package



1 3/8" Dock Dots

The smallest solar lights you have ever seen! Easy to install in minutes with a quick 1 3/8" drill bit or hole saw.

Available in:
white/blue/green/amber/red
\$ 55.⁹⁵
package of 4



Deck Lights

Industrial strength solar powered dock light made from marine grade anodized aluminum for superior protection in harsh marine environments.

Available with white LEDs only
\$ 39.⁹⁵
each

Aqua Dock Lights

Aqua Dock Lights are designed to attract a natural food chain by luring bait fish which in turn will attract larger fish, turning your waterfront property into a virtual aquarium.

- Up to 40' diameter of light
- Easy depth adjustment
- 100,000+ hrs. LED lifespan
- Costs only pennies per day to operate

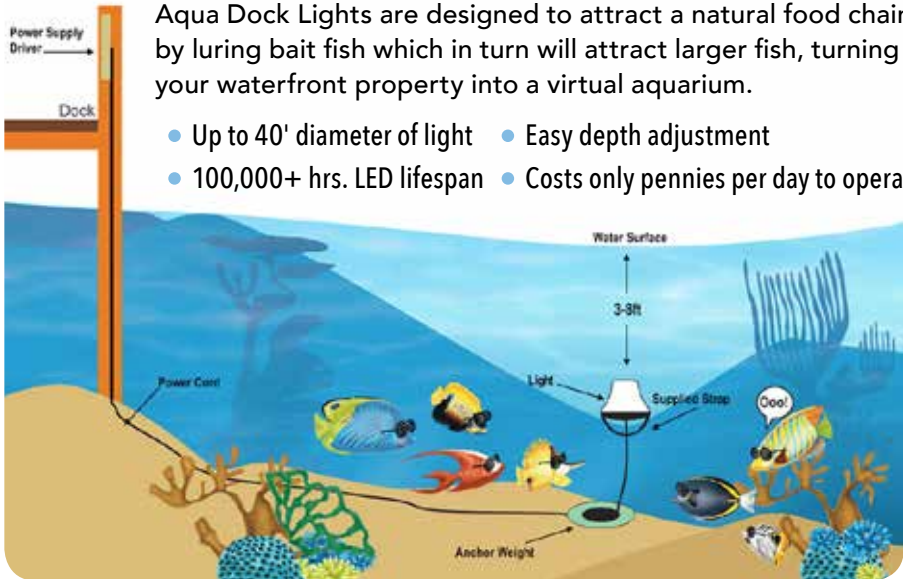

Apollo underwater LED system includes:

- (1) Apollo light & AC to DC power supply
- (1) 3 lb. weight & weight strap
- 40' power cord (longer lengths available)
- Choice of blue, green, orange, red or white color

Model #AD-APOLLO **\$ 512.⁴⁹**

Apollo model is recommended for water depths of 3' - 5'.
For depths over 5 feet, please inquire about other models & options available.

BIRD•B•GONE Inc. **Sea Gull Eliminators**

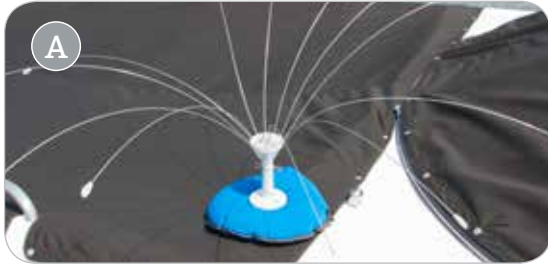

A Bird-B-Gone® Bird Spider 360°

The Bird-B-Gone's spider's spinning motion is effective at deterring birds from landing on your boat, swim raft or dock. Stainless steel arms with scuff-preventing polycarbonate tips move with the breeze. *Mount permanently (screws included) or use an optional rail, bimini or sandbag mount.*

Model #MMBS400SPN (4' diameter) **\$ 49.99**

Model #MMBS800SPN (8' diameter) **\$ 59.99**



B Bird-B-Gone® 360° Repellent

6' diameter, wind driven rotator keeps birds from roosting on your boat, swim raft or dock. Includes standard mounting block (screws included). *Optional rail, bimini or portable sandbag mounts sold separately.*

Model #MMRPL360 **\$47.99**



Rail Mount

For mounting to boat railing 1" to 1.86" in size and other surfaces that will accept a C-clamp.

Model #MMRLMNT **\$22.99**



Sandbag Base

Attaches directly to either style repeller and comes with all the necessary hardware. Has eyelets around outer ring for extra security. *Weighs 8 lbs.*

Model #MMBSBB-SB **\$41.99**



Boat Base

Used to secure either style bird repellents to masts, spreaders and other areas. Comes with all the necessary hardware.

Model #MMBSBB2 **\$9.99**

Dock Pro® Dock Cart

The Dock Pro dock cart is simply the easiest way to carry all your gear to your boat. Features a spacious 7 cu. ft. (47" L x 23" W x 13" D) heavy wall roto-molded poly-tub that will not rust or rot. Zinc coated corrosion resistant hardware used throughout. Plastic rim wheels with roller bearings will stand up to the harshest marine environment.



plastic rim wheels will stand up to the harshest marine environment

Item #TAY1060 **\$ 279.99**
 Dock cart with solid wheels (300 lb. capacity)

A Adjustment Kit

Adjust the level of your dock with this kit that slides over the 1 1/2" leg pipe. Available for all leg & wheel docks with 1 1/2" pipe. Sold as a pair (winch with sleeve and hook).

\$ 245 / pair



B Spud Puller & Pounder Kit

This (2) piece system aids in the installation and removal of spud pole anchors for our floating dock systems.

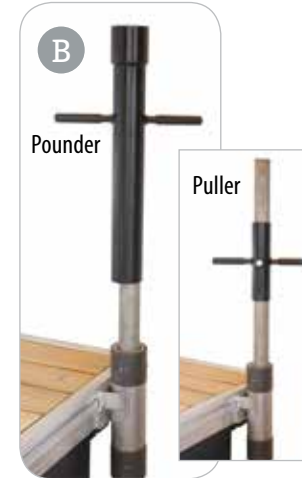

2" puller/pounder kit:
\$ 249

3" puller/pounder kit:
\$ 309

C Boat Lift Wheel Kits

Specifically designed for use with RGC® boat lifts and can be modified for use with hydraulic boat lifts. Includes a pair of welded galvanized steel mounting brackets and (2) heavy duty polyethylene wheels.

BLW2045 (fits 2,000 - 4,500 lb. lifts): \$ 292 / pair

BLW5060 (fits 5,000 - 6,000 lb. lifts): \$ 305 / pair

D Air Bag Lift Kits

Inflatable 250 and 500 lb. capacity air bags with attachment strap to float your boat lift for seasonal installation and removal. Ideal when used in conjunction with a wheel kit (see photo on right). Includes connecting kit (carabiner and strap).

250 lb. capacity: \$ 235 500 lb. capacity: \$ 350



Boat lift accessories available for seasonal installation and removal. Make the seasonal installation and removal of your boat lift easier with a wheel kit and/or air bag lift system.

Smarte Jack™

Smarte Jack™ makes moving your boat lift easy and quick. Once you attach the Smarte Jack™ retractable wheel kit to your boat lift, you don't have to remove it unless you want to.

- Jack raises or lowers with a wrench or a cordless drill; 18" adjustability
- Fits most boat lifts and installation is a snap
- Heavy-duty aluminum construction
- 700lb. capacity
- Fits 2" or 1 7/8" I.D. plastic wheel
- Mounting hardware included
- One pair per box
- For use with optional wheels (*sold separately*)

Smarte Jack™: \$ 365 / pair

optional wheels: \$ 130 / pair



Watch a video on our website at:
www.thedockdoctors.com/boatlift-removal

Boat Lift Helper

The Boat Lift Helper is made of the same tough material that the military uses to raise sunken equipment from the ocean floor. The heavy-duty air-lift-bags will raise your boat lift up off the lake bottom for simple positioning right from your dock. No need to muscle your boat lift through muddy, sandy, rocky, or weedy lake bottoms.

Mid-season when lake water levels change, simply re-inflate the Boat Lift Helper's powerful air-lift-bags to move your boat lift into a new position. No hassles or need to re-attach wheels and no special air compressors are required.

Boatlift Beam Width	Recommended Kit	Price
108"	7' bag kit	\$ 1,545
116"	8' bag kit	\$ 1,595
124"	9' bag kit	\$ 1,745



Watch a video on our website at:
www.thedockdoctors.com/boatlift-removal





Our standard duty aluminum frame leg and wheel docks are designed for protected sites with minimal wave action, feature an exceptionally strong aluminum frame. These strong yet lightweight docks are easy to assemble and can be installed by one person.



Complete our **site survey** on our website and we will send you a free quote and conceptual layout customized to your property.
www.thedockdoctors.com/site-survey



Lake Groton, Groton, VT

Standard Duty Aluminum Leg & Wheel Docks

- Exceptionally strong aluminum frame
- Support stanchions built into the frame, for an obstruction-free dock edge
- Removable decking in cedar, aluminum, NyloDeck® composite® - or attached Sure-Step® decking
- Optional powder-coated frame



***EASY** one person install*

Our innovative connector clips and lightweight sections allow for one person to easily connect sections together and install the dock system.

Wheel docks easily roll in and out as the water fluctuates during the season.



Standard duty aluminum wheel docks with cedar decking and optional dock mounted roller.

*Dock mounted roller
(see page 13)*

See pp. 48-52 for more information on our small craft launch systems.



*Standard duty aluminum leg dock with Sure-Step® decking and our freestanding launch port system
(see page 49).*



Standard duty aluminum docks used to create a shoreside deck area.



*Single craft storage arms
(see page 13)*



4' x 8' Leg Dock



4' x 12' Wheel Dock



Standard Duty Aluminum

see decking details on p. 15

Size	Weight*			 <small>see color choices on p. 15</small>	
		CEDAR	ALUMINUM	NYLODECK®	SURE-STEP®
		Price	Price	Price	Price
LEG DOCKS					
4' x 8'	49 lbs.	\$ 549	\$ 759	\$ 865	n/a
4' x 10'	63 lbs.	\$ 629	\$ 879	\$ 1,019	n/a
4'3" x 8'5"	99 lbs.	n/a	n/a	n/a	\$ 729
4' 3" x 10' 5"	125 lbs.	n/a	n/a	n/a	\$ 839
WHEEL DOCKS					
4' x 12'	95 lbs.	\$ 1,055	\$ 1,349	\$ 1,495	n/a
4' 3" x 12' 5"	149 lbs.	n/a	n/a	n/a	\$ 1,309

Dock pricing includes frame and removable decking. Wheel dock pricing includes (1) pair of wheels and axle assembly. The necessary assembly components are sold separately.

*Weights for docks with cedar, NyloDeck® or aluminum decking do not include the decking. Sure-Step® decking attaches directly to the dock frame and is not removable. Please allow additional order time for powder coated frame upgrade.



Assembly Components



Connector Clips
for connecting docks
together
\$ 23.⁰⁰ set of 2



Safety Cap
for 1 1/2" pipe
\$ 4.⁹⁵ each



Aluminum
Pipe 1 1/2"
cut to length pending
water depth
\$ 6.⁹⁵ / foot



Footpad
(aluminum)
\$ 32.⁰⁰ each



Cross Braces
(optional)
stabilizes docks in
deeper water
\$ 137.⁰⁰



*Our **medium duty aluminum frame leg and wheel docks** offer superior strength and stability, featuring taller frames and longer and wider sections than our standard duty frames. Easy to assemble and install, the support stanchions are built into the frame and flush to the sides of the dock, allowing for an obstruction-free dock edge.*



Medium Duty Aluminum Leg & Wheel Docks

- Exceptionally strong, 7" tall aluminum frame
- Support stanchions built into the frame for an obstruction-free dock edge
- Removable cedar, NyloDeck® composite or aluminum decking panels
- Optional powder-coated frame
- Trex® decking also available



EASY assembly & installation

No sharp edges on underside of frames make our aluminum docks easy on the hands for carrying.

Complete our **site survey** on our website and we will send you a free quote and conceptual layout customized to your property.
www.thedockdoctors.com/site-survey



Medium duty aluminum leg docks with NyloDeck® decking.



Medium duty aluminum leg docks with aluminum decking. Accessed by our adjustable aluminum stairs (see pages 42-43).



Dock sections installed side by side to create an "L" shape with optional triangle section for more deck space.

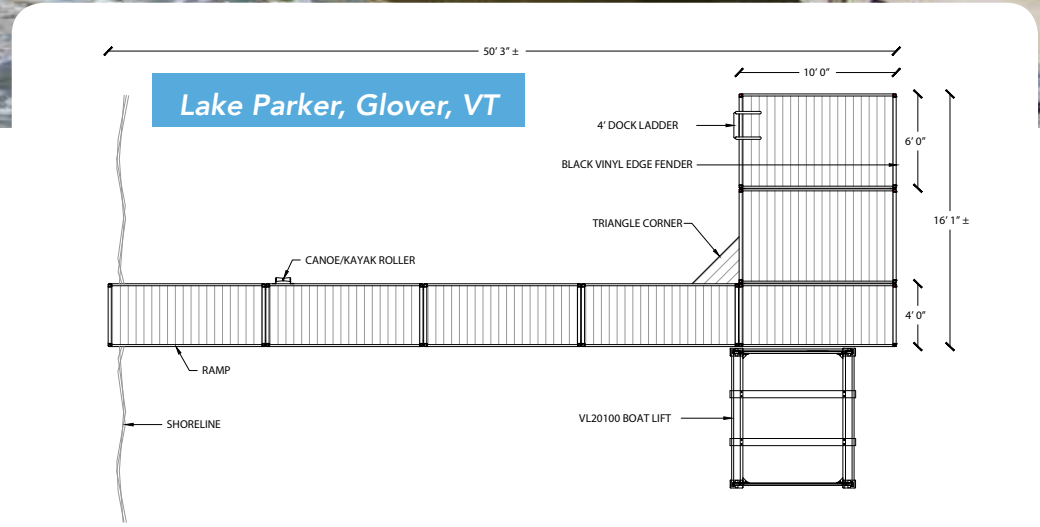

Visualize any of these designs for your property:
 Arrange in a variety of layouts to suit your site and individual needs.



Silver Lake, NY



Medium duty aluminum leg docks with cedar decking, aluminum ladder (see page 8) and pipe-mounted flagpole (see page 14).



***EASILY* adjust height**

Easily adjust the height using our winch adjustment kit (sold separately on page 18).



Medium duty aluminum leg docks with shallow water stairs (see p. 8) and kayak/canoe roller (see p. 13).



Medium duty aluminum leg docks with NyloDeck® decking at a town beach in Washington, NH.



Accessory Ideas: see pages 8-19 for full details and more accessory options



shallow water stairs



solar lighting



dock-mounted roller



6' x 8' Leg Dock



4' x 16' Wheel Dock



Assembly Components



Connector Clips
for connecting docks together
\$ 33.00 set of 2



Safety Cap
for 1 1/2" pipe
\$ 4.95 each



Aluminum Pipe 1 1/2"
cut to length pending water depth
\$ 6.95 / foot



Footpad (aluminum)
\$ 32.00 each



Cross Braces (optional)
stabilizes docks in deeper water
\$ 137.00 (4' wide docks)
\$ 147.00 (6' wide docks)

Medium Duty Aluminum

see decking details on p. 15

Size	Weight*	see color choices on p. 15		
		CEDAR Price	ALUMINUM Price	NYLODECK® Price
LEG DOCKS				
4' x 8'	71 lbs.	\$ 695	\$ 909	\$ 1,009
4' x 10'	85 lbs.	\$ 799	\$ 1,045	\$ 1,167
4' x 12'	100 lbs.	\$ 889	\$ 1,185	\$ 1,339
6' x 8'	89 lbs.	\$ 899	\$ 1,199	\$ 1,359
6' x 10'	107 lbs.	\$ 1,035	\$ 1,409	\$ 1,629
6' x 12'	125 lbs.	\$ 1,159	\$ 1,629	\$ 1,875
3' x 3' Triangle Corner	30 lbs.	\$ 399	\$ 465	\$ 499
WHEEL DOCKS				
4' x 16'	129 lbs.	\$ 1,569	\$ 1,975	\$ 2,199
6' x 16'	161 lbs.	\$ 1,779	\$ 2,389	\$ 2,715

Dock pricing includes frame and removable decking. Wheel dock pricing includes (1) pair of wheels and axle assembly. The necessary assembly components are sold separately. *Weights for docks do not include the decking. Trex® decking also available as a special order. Please allow additional order time for powder coated frame upgrade.



Powder Coated Frame Upgrade
please call for pricing



*Designed for exposed sites and rough water conditions, our **heavy duty steel truss leg and wheel docks** are incomparable for strength and durability. The heavy duty steel truss frame allows water to pass through the frame.*





Steel truss leg docks used to transition over a rocky shoreline.



Heavy duty steel truss dock with 6' x 10' sections and cedar decking.

Heavy Duty Steel Truss Leg & Wheel Docks

- Heavy duty 9" galvanized steel truss frame
- Designed for exposed sites
- Adjustable leg stanchions built into frame
- Removable decking in cedar or NyloDeck® composite (*Trex® or Ipe hardwood decking also available*)
- Optional powder-coated frame
- 10 year limited warranty



6' wide sections optimize dock space for all your activities - shown with optional cedar post covers (see page 14).



Lake Champlain, Plattsburgh, NY

6' wide wheel dock with 4' x 8' "L" section and 2' x 10' catwalk.



EASY to install

Install yourself, or use our seasonal installation and removal service (see inside back cover for more details).

Accessory Ideas: see pages 8-19 for full details and more accessory options



vertical fender



lower access platform shown with aluminum ladder



6' wide heavy duty steel truss leg docks with cedar decking and our pipe-mounted vertical fenders (see page 10).



4' x 10' Leg Dock



4' x 16' Wheel Dock



Heavy Duty Steel Truss

see decking details on p. 15

Size

Weight*

CEDAR

Price

see color choices on p. 15

NYLODECK®

Price

LEG DOCKS

4' x 8'	100 lbs.	\$ 799	\$ 1,105
4' x 10'	115 lbs.	\$ 859	\$ 1,229
6' x 8'	125 lbs.	\$ 1,035	\$ 1,395
6' x 10'	150 lbs.	\$ 1,095	\$ 1,679
2' x 10' Catwalk (std duty)	75 lbs.	\$ 459	\$ 675
3' x 3' x 4' Triangle Corner	45 lbs.	\$ 279	\$ 365

WHEEL DOCKS

4' x 16'	208 lbs.	\$ 1,699	\$ 2,315
6' x 16'	230 lbs.	\$ 1,925	\$ 2,829
4' x 16' with 4' x 8' L	328 lbs.	\$ 2,510	\$ 3,429
6' x 16' with 4' x 8' L	350 lbs.	\$ 2,735	\$ 3,975

 Ipe hardwood &  Trex® composite decking also available as a special order.

Dock pricing includes frame and removable decking. Wheel dock pricing includes (1) pair of wheels and axle assembly. The necessary assembly components are sold separately. *Weights for docks do not include the decking. Please allow additional order time for powder coated frame upgrade.



Assembly Components



Connecting Brackets
each connection requires (4)

End-to-end: \$12.⁵⁰ ea

Side-by-side: \$12.⁵⁰ ea

Catwalk (3"): \$10.⁵⁰ ea
catwalk requires (2) 3" brackets & (2) truss end-to-end brackets



Safety Cap
for 1 1/2" pipe

\$ 4.⁹⁵ each

Galvanized Pipe

1 1/2" cut to length
pending water depth

\$ 6.⁹⁵ / foot



Footpad
(galvanized steel)

\$ 34.⁰⁰ each



Dock Panel Securing Cord

\$ 4.⁹⁵ set of 4



Cross Braces

(optional) stabilizes
docks in deeper water

\$ 137.⁰⁰ (4' wide docks)

\$ 147.⁰⁰ (6' wide docks)



*Designed for use in rough and deep water applications, our **mega duty steel truss leg and wheel docks** feature taller frames, longer and wider sections, and larger diameter upright supports. Available in two stock sizes (or contact us for custom size dock options).*

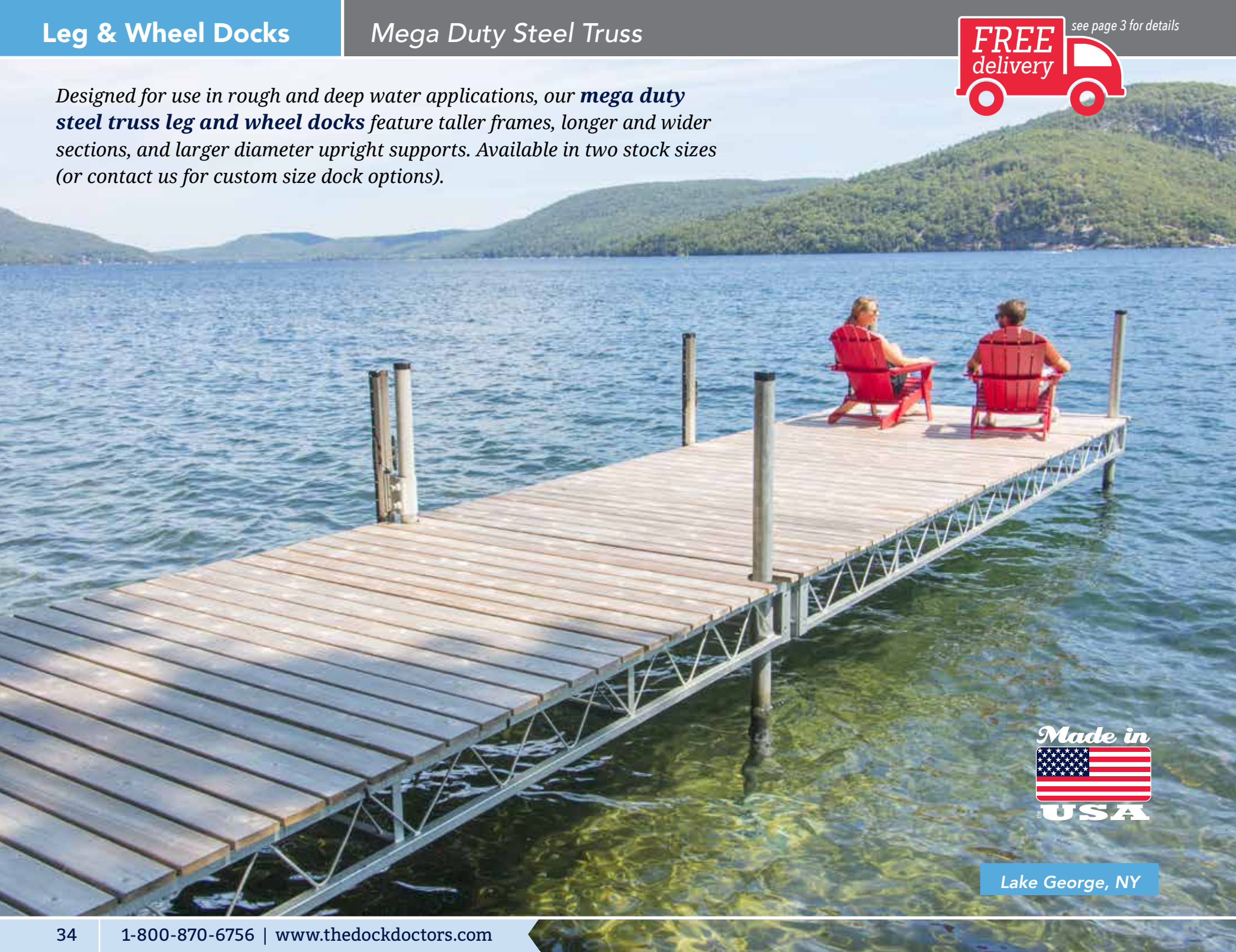

Lake George, NY

Mega Duty Steel Truss Leg & Wheel Docks

- Designed for use in rough & deep water applications
- 11" tall galvanized steel truss frame
- 3" diameter upright supports
- Stocked in 6' × 20' & 8' × 20' sizes (custom sizes available)
- Adjustable leg stanchions built into frame
- Removable cedar or NyloDeck® composite decking panels (Trex® or Ipe hardwood also available)



Mega dock with NyloDeck® decking, aluminum gangway (see p. 41) and our ultimate boat lift with Sunbrella® canopy (see pages 60-63).



6' × 20' mega duty steel truss dock with a 4' × 16' heavy duty ramp section to transition over rocky shoreline.



6' x 20' mega duty steel truss docks with 3' x 24' aluminum gangway, (2) 1,250 vertical PWC lifts, and our 6,000 lb. Ultimate boat lift.

Heavy Duty vs. Mega Duty Frames

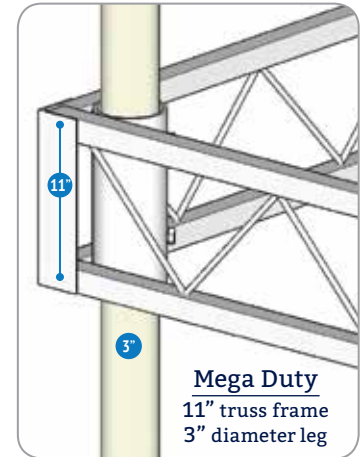
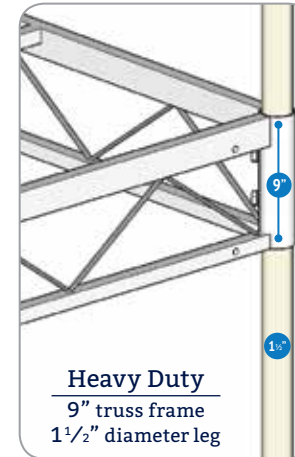

Accessory Ideas: see pages 8-19 for full details and more accessory options



aluminum ladder



boarding handle



flag pole



vertical fender



mooring whips

protect your boat with our adjustable vertical fenders



Our mega dock used as shoreside access to a custom floating dock (see our Custom Catalog).

Mega Duty Steel Truss

see decking details on p. 15

Size **Weight***

LEG DOCKS

		 CEDAR Price	<small>see color choices on p. 15</small>  NYLODECK® Price
6' × 20'	400 lbs.	\$ 3,569	\$ 4,719
8' × 20'	480 lbs.	\$ 4,769	\$ 6,269

WHEEL KITS

for 6' wide docks	\$ 439
for 8' wide docks	\$ 459

 Ipe hardwood &  Trex® composite decking also available as a special order.

Pricing includes dock frame and removable decking. Custom sizes available as a special order. Wheel kits sold separately (see above). The necessary assembly components are sold separately. *Weights do not include the decking. Please call for pricing on custom upgrades. Please allow additional order time for powder coated frame upgrade.



Assembly Components



Connecting Brackets
each connection requires (4)
\$ 24.⁰⁰ each



Safety Cap for 3" pipe
\$ 6.⁵⁰ each
Galvanized Pipe 3"
cut to length pending water depth
\$ 12.⁹⁵ / foot



Footpad for 3" pipe
(galvanized steel)
\$ 47.⁰⁰ each



Dock Panel Securing Cord
\$ 4.⁹⁵ set of 4



Cross Braces (not shown)
(optional) stabilizes docks in deeper water
\$ 168.⁰⁰ (6' wide docks)
\$ 178.⁰⁰ (8' wide docks)



Mega Dock Adjustment Kit
Adjust the level of your dock with this kit that slides over the 3" leg pipe.
\$ 419 / pair



Our **medium duty aluminum floating docks** feature our “aluminum track” frame - allowing for easy mounting of hardware and accessories. These pre-manufactured “stock” docks are readily available for pick up, delivery or installation and are designed to be easily installed for the do-it-yourselfer.



Schroon Lake, NY

Medium duty aluminum floating docks with cedar decking, spud pole anchors, vertical fenders and mooring whips.

Medium Duty Aluminum Floating Docks

- Used in residential & light commercial applications
- Exclusively designed frame by **The Dock Doctors®**
- Universal track-style 5" tall aluminum frame allows for easy mounting of hardware & accessories
- Removable decking in cedar, aluminum or NyloDeck® composite
- Commercial grade, watertight, polyethylene shell floats (100% sealed with an expanded polystyrene foam)



T-shaped medium duty floating dock with float frame to support the ramp; the float frame is adjusted during installation based on the pitch of the ramp.

Our heavy duty aluminum docks are ideal for sites with more exposure (see pages 4–5 in our custom catalog).



Vertical Fender
spud anchor mounted

Vertical fenders designed to attach to either the spud anchor bracket (above) or dock frame (below) – see page 10.





Vertical Fender
track mounted

Washington, NH



Medium Duty Aluminum Floating

see decking details on p. 15

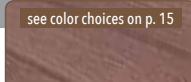
Size	Weight*			 <small>see color choices on p. 15</small>
		CEDAR Price	ALUMINUM Price	NYLODECK® Price
FLOATING DOCKS				
4' x 12'	225 lbs.	\$ 1,399	\$ 1,699	\$ 1,865
4' x 16'	260 lbs.	\$ 1,749	\$ 2,149	\$ 2,375
6' x 12'	270 lbs.	\$ 1,885	\$ 2,355	\$ 2,589
6' x 16'	350 lbs.	\$ 2,362	\$ 2,969	\$ 3,309
8' x 12'	410 lbs.	\$ 2,325	\$ 2,929	\$ 3,269
8' x 16'	483 lbs.	\$ 2,869	\$ 3,675	\$ 4,119



Pricing includes frame, decking and flotation. Anchoring, connecting hardware and shore mount sold separately. Note: Docks used as a shore ramp may require adjustable float frame and shore connection pending layout. *Weights do not include the decking.

Assembly Components

Hinge Connector Kits

hinge connector kits include bushing, stainless steel pins, wear and dampener system and protective cap (cap not shown)



- \$ 157
(for 4' wide docks)
- \$ 162
(for 6' wide docks)
- \$ 167
(for 8' wide docks)



Anchor Mounts
Spud Pole \$ 210
pipe sold separately



Chain Tube \$ 109
chain for anchoring
sold separately



Our gangways are available with minimal time frames in any length / width





5' x 80' ADA compliant gangway for NYSDEC boat launch in Crown Point, NY. Please contact us for a free quote & site visit for your project.



4' x 30' gangway during manufacturing

Aluminum Gangways

see decking details on p. 15

Size	Weight*		
		CEDAR Price	ALUMINUM Price
RESIDENTIAL			
3' x 24'	295 lbs.	\$ 2,959	\$ 3,425
COMMERCIAL			
3' x 24'	400 lbs.	\$ 3,599	\$ 4,069
4' x 18'	470 lbs.	n/a	\$ 4,165
4' x 24'	610 lbs.	n/a	\$ 5,390
4' x 30'	760 lbs.	n/a	\$ 6,485
custom size & length with minimal time-frames		please call	please call

Pricing for all gangways includes decking and handrails. Commercial quality gangways are readily available in any length and with other types of decking; please call for pricing. Hinge connections and shore mounts sold separately.

*Weights listed do not include the decking.



Our lightweight **aluminum portable stairs** are rigid and adjustable, with features designed to accommodate a variety of waterfront applications. Offering a lifetime of virtually maintenance free features, these quality aluminum stairs are an economical solution for waterfront access and ideal for replacing your old wooden steps.

Aluminum Stair Features

- Readily available in lengths up to 18' 9"
- Adjustable rise & run (27 to 44 degrees) to accommodate your site
- Custom fabrication available for specific applications & lengths
- Lightweight & easy to carry for a two-person installation
- Non-skid, 28" wide stair treads
- Marine grade aluminum extrusions with stainless steel fasteners
- Rounded aluminum handrails on both sides
- Optional adjustable footpads for base of stairs
- Includes mounting bracket
(designed for easy seasonal installation & removal of stairs)



Non-skid, 28" wide
stair treads



Stair platform for top and/or bottom of stairs.

Aluminum Stairs

All stairs are 28" wide

All stairs can be assembled to fit any distance between the minimum and maximum rise.

# of Steps	Price*	Minimum Rise	Run	Length	Maximum Rise	Run	Length	Weight
		@ 6" (27°)	with 6" rise	with 6" rise	@ 9" (44°)	with 9" rise	with 9" rise	
4	\$ 679	2' 0"	4' 7"	5' 0"	3' 0"	3' 11"	4' 11"	65 lbs.
6	\$ 949	3' 0"	6' 6"	7' 2"	4' 6"	5' 6"	7' 1"	93 lbs.
8	\$ 1,129	4' 0"	8' 5"	9' 4"	6' 0"	7' 1"	9' 3"	115 lbs.
10	\$ 1,349	5' 0"	10' 4"	11' 6"	7' 6"	8' 8"	11' 5"	142 lbs.
12	\$ 1,589	6' 0"	12' 3"	13' 8"	9' 0"	10' 2"	13' 7"	164 lbs.
14	\$ 1,799	7' 0"	14' 2"	15' 10"	10' 6"	11' 9"	15' 9"	173 lbs.
16	\$ 2,049	8' 0"	16' 1"	18' 0"	12' 0"	13' 3"	17' 11"	188 lbs.
n/a	\$ 549	3' x 4' stair platform (standard duty aluminum with aluminum decking)						32 lbs.

*Price includes mounting bracket (fasteners to existing platform not included); handrails down each side and slip resistant stair treads. Stair uprights remain vertical in any rise. Optional top and/or bottom stair platform in 3' x 4' standard duty aluminum (see photo on p. 42). Optional pair of Adjustable Footpads includes brackets to mount to bottom of stairs, 1 1/2" aluminum support pipes 24" long, black safety caps & aluminum footpads. Requires stair frame drilling on-site to mount.

Assembly Options: *Unassembled:* Requiring assembly on site to contour to desired rise (note: some drilling is required). *Pre-assembled:* Factory assembled and adjusted to desired rise (note: additional assembly charge will apply). *Prices do not include shipping/delivery – please call for pricing.



mounting bracket



rounded aluminum handrail



(optional)
Adjustable Footpad
\$179 /pair

Requires drilling stair on-site to mount.



Our aluminum-frame paddle docks feature heavy duty aluminum frames suitable for commercial or residential applications. Their modular design allow for a variety of layout options.



Lake Pauline, Ludlow, VT

Heavy Duty Aluminum Paddle Docks

- 7" Aluminum Track Frame with 6"-10" freeboard (approximate – pending sections, size & decking choices)
- Heavy duty, stainless-steel connection hinges
- Optional powder coated frame
- Cedar or NyloDeck® composite decking
- Foam filled black polyethylene floats
- Optional marine-grade black vinyl edge fender
- Optional debris diverter protects the dock from floating debris often seen in river settings



Optional angled ladder



Spud pole anchor example



Croton on Hudson, NY

Powder coated heavy duty aluminum paddling dock with dock mounted kayak rack.



Mirror Lake, Lake Placid, NY

Paddle dock shown with NyloDeck® composite decking & powder coated finish.

Paddle Docks Heavy Duty Aluminum

Standard Size	Price
8' x 20'	as low as \$5,199
10' x 20'	as low as \$6,450
8' x 16' ramp section	as low as \$3,969

Custom sizes and wider ramps available. Standard pricing includes aluminum frame, cedar decking and flotation. Site conditions, exposure, anchoring details and ramp requirements to be determined for final pricing.



Our heavy duty, aluminum-frame rowing docks feature a modular design for a variety of layout options. Designed for commercial or residential applications.

Photo by Karen Bobotas



St. Paul's School, Concord, NH

Heavy Duty Aluminum Rowing Docks

- 7" Aluminum Track Frame with 6" freeboard
- Heavy duty, stainless-steel connection hinges
- Modular track-style frame allows easy additions of optional components and multiple layout options
- Cedar or NyloDeck® composite decking (Ipe hardwood decking also available)
- Foam filled black polyethylene floats
- Optional marine grade black vinyl edge fender
- Optional debris diverter protects the dock from floating debris often seen in river settings

Rondout Rowing Club, Kingston, NY



Rowing Docks

Heavy Duty Aluminum

Standard Size	Price
8' x 20'	as low as \$ 5,199
10' x 20'	as low as \$ 6,450
8' x 16' ramp section	as low as \$ 3,969
8' x 20' flared ramp section	as low as \$ 5,290

Custom sizes and wider ramps available. Standard pricing includes aluminum frame, cedar decking and flotation. Site conditions, exposure, anchoring details and ramp requirements to be determined for final pricing.

Accessories & Options:

A Wheel Kit	\$ 789 / set
B Angled Dock Ladder (aluminum finish)	\$ 369
B Angled Dock Ladder (powder coated finish)	\$ 489
C Tongue Kit (includes jack)	\$ 419
D Motor Mount (motor not included)	\$ 229

Items not shown - and/or call for more details:

Debris diverter 8' long	as low as \$ 2,599
Debris diverter 10' long	as low as \$ 3,249
Hinge connections	as low as \$ 319/ set
Edge fender (black vinyl)	



Rowing Dock Accessories



Axle & Wheel mounts for seasonal installation and removal.



Angled ladder - available in marine-grade aluminum or powder coated finish.



Move your rowing dock with ease by land or water with our optional wheel and tongue assembly or motor mount.



Our aluminum **Dock & Launch Systems** offer a modular design and multiple layout options for both residential and commercial applications. Use as an independent launch system, or as part of a complete dock system to accommodate your other waterfront activities, including swimming, lounging and boating.



Residential Dock & Launch System

- Foam filled black polyethylene floats
- Non-skid platform & non-marring Stoltz® rollers
- Boarding handle & grab & launch rails
- Can be used in conjunction with any of our floating dock systems
- 5" tall aluminum track frame
- Choose cedar or NyloDeck® composite decking on main platform & dock fingers (decking is secured directly to the 5" aluminum frame)
- Non-skid Sure-Step® surface on launch ramp (C)

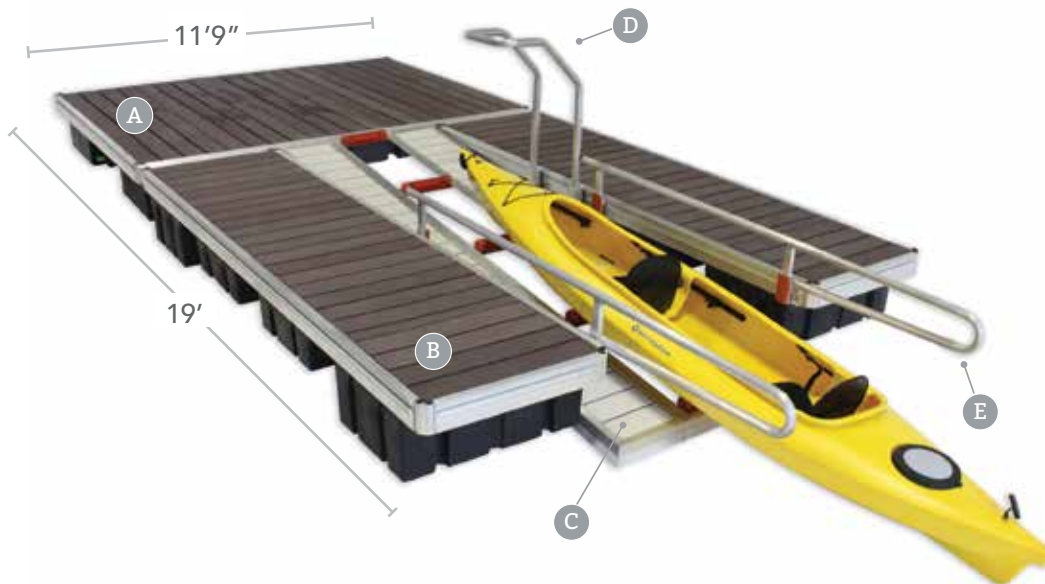

Dock & Launch System Medium Duty Aluminum

Featuring a 5" tall aluminum frame, and 19' x 11'9" overall size, our typical medium duty dock & launch system includes:

- (A) (1) main frame (7' x 11'9") with cedar decking
- (B) (2) dock fingers (3'6" x 12') with cedar decking
- (C) Launch ramp (4' x 12') with built in rollers & Sure-Step® decking
- (D) Boarding handle ● (E) Grab & launch rails

*Site conditions, anchoring & decking selection are necessary to determine final pricing. Please call for a free quote on your project.



***as low as \$ 9,720**

Commercial Launch Systems



See pages 50–51 in our *CUSTOM* catalog for more details.

Floating add on kayak launch

Ideal to add onto existing municipal or commercial floating dock systems that want to upgrade to provide a safer launching experience for paddlers. See our *Paddle Products* catalog, or visit our website for additional information on this product.

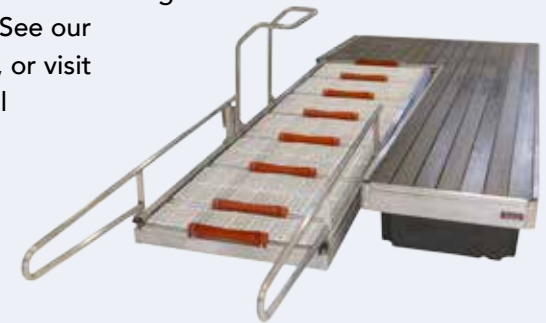

For more information on our launch products, visit our website at: www.thedockdoctors.com/launch-docks

Freestanding Launch Port System



- Ideal for controlled bodies of water with minimal fluctuation
- Non-marring Stoltz® rollers
- Variety of layouts available by adding more leg dock sections to accommodate individual sites
- Optional grab & launch rails offer more control for gliding on and off the launch platform
- See our *Paddle Products* catalog or visit our website for more details



Easy-access boarding handle



Grab & launch rails

Freestanding Launch Port Standard Duty Aluminum

Base unit includes:

(1) 4' x 8' & (1) 4' x 10' standard duty leg dock sections and (1) 4' x 12' launch ramp.

Item

Freestanding Launch Port System

Boarding handle (optional)

Grab & launch rails (optional)



SURE-STEP®

Price

\$ 4,099

\$ 309

\$ 525

Our innovative **Kayak Lift & Launch** systems provide a smooth transition for you and your paddle craft to and from the water. Available with built-in ladder to accommodate seawalls or permanent docks or without the ladder for docks that are only a minimal distance off the water. For more information and to see a product video please visit our website at: www.thedockdoctors.com/ladder-lift-launch

Watch a video of the kayak ladder lift at: www.thedockdoctors.com/ladder-lift-launch

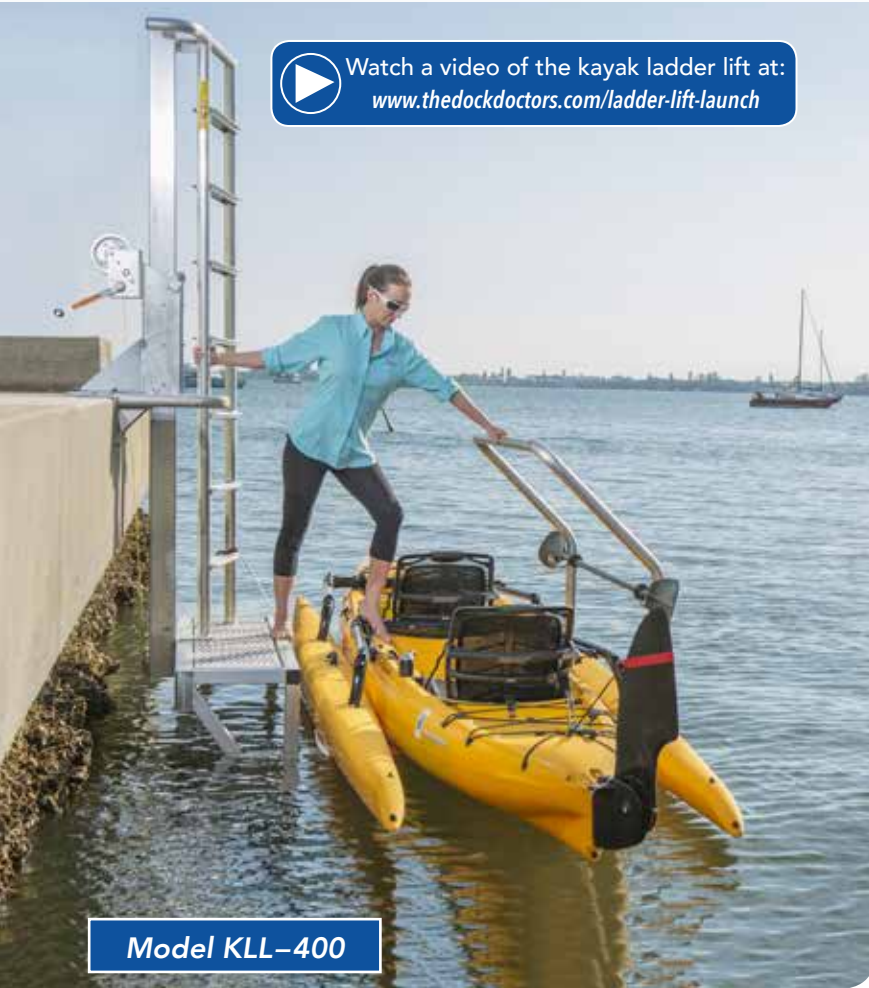

Model KLL-400

Above: New model to accommodate larger crafts such as the Hobie Mirage® Tandem shown above.
 Right: KLL-100 model shown with optional powder coated finish.

- Ladder Lift mounts to seawalls or permanent docks with a 6' lift height
- Manual winch to raise and lower the platform (electric winch available for ladder models KLL-100 and KLL-400)
- Units without the ladder option offer 30" of lift height
- All models include boarding handle with built-in paddle hooks
- Sure-Step® UV resistant decking on platform
- Adjustable aluminum & vinyl bunks
- 100 lb. capacity lifts available with or without the ladder
- 400 lb. capacity lift available with ladder only



Left: Sure-Step® decking on platform. Adjustable aluminum & vinyl bunks accommodate all kayaks, canoes & paddle boards (not designed for Jet skis).

Kayak Ladder Lift & Launch

For sites with fluctuating water

Our Kayak Ladder Lift & Launch has a lifting height of 6' and mounts to seawalls or permanent docks. Available in standard marine-grade aluminum or powder coated white finish. Includes manual winch, boarding handle, kayak leash and adjustable aluminum & vinyl bunks.

Model	Maximum Craft Weight	aluminum	WHITE powder coated
		Price	Price
A KLL-100 with manual winch	100 lbs.	\$ 2,099 <i>MSRP \$ 2,349</i>	\$ 2,649 <i>MSRP \$ 2,900</i>
B KLL-400 with manual winch	400 lbs.	\$ 3,099 <i>MSRP \$ 3,359</i>	\$ 3,519 <i>MSRP \$ 3,839</i>

Kayak Launch: Dock Mounted

For docks that are a minimal distance off the water, our dock mounted Kayak Launch has a lifting height of 30". Includes manual winch, boarding handle, kayak leash and adjustable aluminum & vinyl bunks.

Model	Maximum Craft Weight	aluminum
		Price
C KDL-100 with manual winch	100 lbs.	\$ 1,899 <i>MSRP \$ 2,049</i>

Concrete Mounting Installation Kit (not shown)

Includes parts for installation on concrete surface.

KLL100 Install Kit: (4) pieces of 1/2" threaded stainless steel rod with Epoxy tube; (4) stainless steel 1/2" nuts, flat & lock washers & Never-Seez®. **\$89**

KLL400 Install Kit: (4) pieces of 5/8" threaded stainless steel rod with Epoxy tube; (4) stainless steel 5/8" nuts, flat & lock washers & Never-Seez®. **\$99**

Note: installation will require an electric hammer drill with concrete bit sized accordingly for the rod listed above.

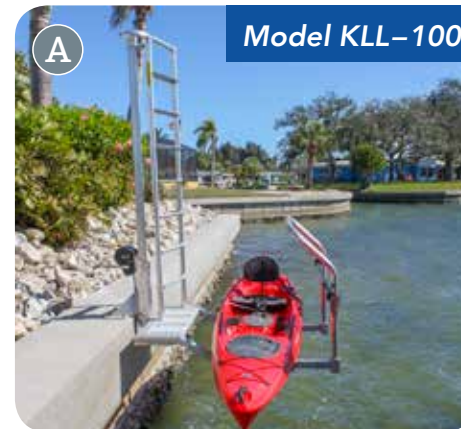

Optional Accessories



Kayak Roller: \$160

not available for use with top transition step



Top Transition Step: \$255



Electric Winch
A/C: \$475 D/C: \$475



Lifting Height..... 75"
 Overall Width..... 73"
 Overall Length..... 144"
 Weight..... 400 lbs
 (with platform)

▶ Watch a video of the launch port lift at:
www.thedockdoctors.com/launch-port-lift

Launch Port Lift

- Ideal for fluctuating water
- Aluminum vertical boat lift with launch port
- Non-marring Stoltz rollers
- Non-skid Sure-Step® platform
- Stainless steel fasteners & cables
- 30" handwheel raises & lowers the platform
- Includes 18" adjustable legs (other lengths available)

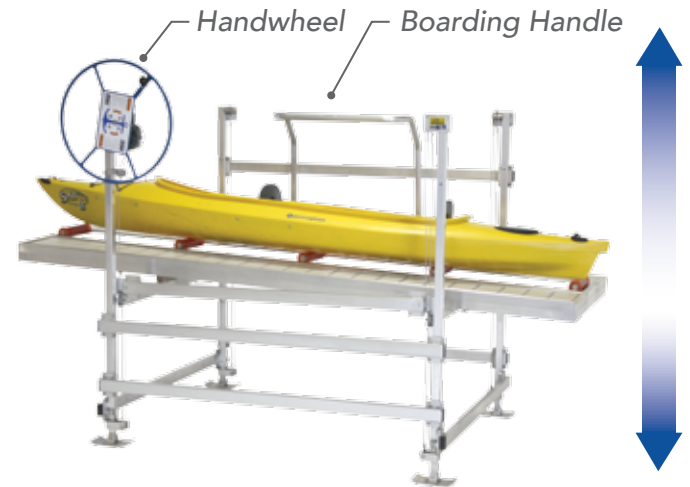

30" handwheel easily raises & lowers the launch platform.



Easy-access boarding handle (optional) & non-skid Sure-Step® platform.

Launch Port Lift

FREE
 delivery 
see page 3 for details

Item	Price
Assembled	\$ 4,489
Unassembled	\$ 4,289
<i>optional items:</i>	
Boarding handle	\$ 309
Grab & launch rails	\$ 525



PWC & Small Craft Lifts

- 1,000 lb. & 1,200 lb. capacity cantilever models
- Stainless steel hardware & cables
- Polymer pulley sheaves prolong cable life
- Dual mounting winch (left or right side)
- 15 Year Limited Warranty
- 1,250 lb. vertical & 2,000 lb. hydraulic models also available (see VL section on p. 55 or HL section on p. 58)



Model	PL1000	PL1200	PL1200W
Capacity	1,000 lbs	1,200 lbs	1,200 lbs
Max. Beam	64"	70"	87"
Lifting Height	46"	46"	46"
Bed Length	72"	96"	96"
Min. Water Depth	9"	10"	10"
Overall Width	72"	80"	98"
Adjustable Legs	(4) @ 18"	(4) @ 18"	(4) @ 18"
Shipping Weight	155 lbs	257 lbs	316 lbs
List Price	\$ 1,440	\$ 1,975	\$ 2,420
Sale Price (assembled)	\$ 1,321	\$ 1,775	\$ 2,152
Sale Price (unassembled)	\$ 1,221	\$ 1,675	\$ 2,052



- All stainless steel hardware & cables
- High lifting range
- Minimal water required
- Manufactured in New York State
- 15 year limited warranty
- Delivery & installation available





Aluminum Vertical Boat Lifts

Model #	Weight Capacity	Max. Beam	Overall Width	Overall Length	Lifting Height†	Min. Water	Shipping Weight	List Price	Dock Doctors Price (assembled)	Dock Doctors Price (unassembled)
VL1250*	1,250 lbs	65"	73"	82"	75"	8.5"	233 lbs	\$ 2,405	\$ 2,256	\$ 2,050
VL20100*	2,000 lbs	100"	108"	100"	66"	9.5"	249 lbs	\$ 3,155	\$ 2,994	\$ 2,685
VL35108	3,500 lbs	108"	116"	108"	68"	8"	495 lbs	\$ 4,768	\$ 4,476	\$ 4,064
VL35108T	3,500 lbs	108"	116"	108"	80"	8"	510 lbs	\$ 4,998	\$ 4,672	\$ 4,260
VL45108	4,500 lbs	108"	116"	116"	68"	8"	507 lbs	\$ 5,028	\$ 4,697	\$ 4,285
VL45116	4,500 lbs	116"	124"	116"	68"	8"	510 lbs	\$ 5,178	\$ 4,825	\$ 4,413
VL45116T	4,500 lbs	116"	124"	116"	80"	8"	523 lbs	\$ 5,433	\$ 5,042	\$ 4,630
VL40124 P**	4,000 lbs	124"	132"	141"	68"	8"	445 lbs	\$ 5,358	\$ 5,084	\$ 4,569
VL50124T	5,000 lbs	124"	133"	132"	80"	9"	597 lbs	\$ 5,888	\$ 5,431	\$ 5,019
VL60124T	6,000 lbs	124"	133"	132"	80"	9"	663 lbs	\$ 6,168	\$ 5,717	\$ 5,254
VL70132 TP** ‡	7,000 lbs	132"	141"	138"	78"	11"	800 lbs	\$ 8,703	\$ 8,031	\$ 7,413
VL80124T***	8,000 lbs	124"	133"	132"	78"	11"	777 lbs	\$ 9,393	\$ 8,564	\$ 7,998
VL100132***	10,000 lbs	132"	147"	158"	78"	13"	1217 lbs	\$ 14,900	\$ 13,410	\$ 12,689

All pricing is F.O.B. our facility in Ferrisburgh, VT. Prices are for in stock product only. Additional freight charges may apply for special orders. Boat lift prices include (4) adjustable 29" legs with footpads and carpeted pressure treated bunks. Manual handwheel is included with non-electric models. *Lift includes 18" legs. **Bunks not included with pontoon lift - add desired kit from kits listed at bottom of page. ‡***Lifts include AC Direct Drive with remote control and double carpeted wood bunks. 7k Pontoon lift includes AC Direct Drive w/remote control. † Measured from top of load tubes to bottom of feet when adjustable legs are fully retracted. Measurements are approximate.

Pontoon & Tritoon Cradle Kits

Lift Model	Pontoon Cradle & Guide Kit	Tritoon Cradle & Guide Kit	Pontoon Deck Kit
4000-4500	\$ 860	\$ 1,110	\$ 540
5000	\$ 940	\$ 1,230	\$ 560
6000	\$ 1,030	\$ 1,340	\$ 560
7000	\$ 1,080	\$ 1,390	\$ 615

Pontoon Cradle & Guide Kit

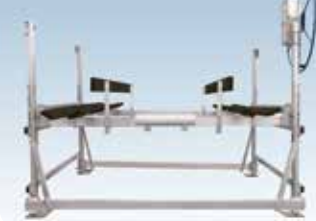

Pontoon Deck Kit



We can deliver and install your boat lift

A VL Vinyl Bunks, Guides, Motor Stops & Extension Legs

Lift Models	Aluminum & Carpeted Guides		Carpeted Guides		Aluminum** Guide Rollers	3" Vinyl Motor Stop	Ext. Legs 4' pair	Ext. Legs 6' pair
	regular adjusts from 16"-25 1/2" high	tall adjusts from 25"-34 1/2" high	regular adjusts from 16"-25 1/2" high	tall adjusts from 25"-34 1/2" high				
3500	\$ 650	\$ 665	\$ 555	\$ 570	\$ 105	\$ 150	\$ 230	\$ 285
4500	\$ 650	\$ 665	\$ 555	\$ 570	\$ 105	\$ 150	\$ 230	\$ 285
5000	\$ 685	\$ 690	\$ 585	\$ 590	\$ 105	\$ 150	\$ 230	\$ 285
6000	\$ 690	\$ 695	\$ 595	\$ 600	\$ 105	\$ 170	\$ 230	\$ 285
8000	n/a	\$ 725	n/a	\$ 630	\$ 105	\$ 180	\$ 230	\$ 285
10,000	n/a	n/a	n/a	\$ 920*	n/a	\$ 180	\$ 295	\$ 335

*Tall guides for 10,000 lb. boat lift adjust 25" – 43 1/2". **The aluminum rollers are a recommended option for the aluminum guides. Credits available with the purchase of a new boat lift: Credit \$95 for a pair of 29" legs if upgrading to longer extension legs with the purchase of a new boat lift.

Electric Drive Units

Lift Models	AC Drive Systems				DC Drive Systems			
	Direct	Direct with remote	Extreme Max Manual	Extreme Max with remote	Direct	Direct with remote	Extreme Max Manual	Extreme Max with remote
3500	\$ 1,575	\$ 2,295	\$ 951	\$ 1,351	\$ 2,195	\$ 2,435	\$ 951	\$ 1,351
4500-5000	\$ 1,625	\$ 2,395	\$ 951	\$ 1,351	\$ 2,195	\$ 2,445	\$ 951	\$ 1,351
6000	\$ 1,625	\$ 2,395	\$ 951	\$ 1,351	\$ 2,195	\$ 2,445	\$ 951	\$ 1,351

Note: Drives listed are for lifts with R18 winches only. Please inquire for pricing and information on electric drives for D&L winches. Credit \$175 for handwheel with the purchase of a direct drive and a new boat lift.

- B Direct Drive** This direct drive uses an industrial oil bath gear reducer and motor with a stainless steel cover which connects to the standard winch. Available with a remote control option. Available as an AC or DC unit.
- C Extreme Max Drive System** Manual key or optional remote control operation with a backup bit for manual operation of the unit in the event of a power outage. Comes complete with mounting kit.
- D VL Solar Power Box** Portable solar power source for waterfront owners with no electricity. Lightweight white fiberglass box holds (2) deep cycle batteries with a power source on/off switch. Available as solar or with an A/C trickle charger. Solar charged: \$ 1,259 A/C charged: \$ 1,209



Shown with optional aluminum & carpeted guides & guide rollers



R18LT Winch with RGC VL Direct Drive



R18LT Winch with (C) Remote Control Extreme Max Power Drive and (D) VL Solar Power Box



Above: "Pacific Blue" canopy.
 Right: Optional "Khaki" colored canvas.

Sunbrella® Boat Lift Canopies

Lift Models	Description	(unassembled) Price
20100	18' × 100"	\$ 2,510
20100	21' × 100"	\$ 2,795
35108/45108	21' × 108"	\$ 2,950
35108/45108	24' × 108"	\$ 3,070
45116	24' × 116"	\$ 3,155
45116	26' × 116"	\$ 3,325
45116	28' × 116"	\$ 3,670
45116	30' × 116"	\$ 3,820
40124/50124/60124/80124	24' × 124"	\$ 3,265
40124/50124/60124/80124	26' × 124"	\$ 3,430
40124/50124/60124/80124	28' × 124"	\$ 3,730
40124/50124/60124/80124	30' × 124"	\$ 3,830
100132	32' × 132"	\$ 4,155
100132	36' × 132"	\$ 4,540

Prices include aluminum canopy frame & fabric in standard colors (Pacific Blue, Cadet Grey & Forest Green). Signature colors available as a special order at an additional cost. Additional costs for shipping may apply for canopies not in stock.



Watch a video on our website at:
www.thedockdoctors.com/boatlift-removal

Effortless Boat Lift Installation and Removal



See pages 18-19 for our complete line of boat lift adjustment & removal accessories



- Available from 2,000 to 12,000 lb. capacity
- Stainless steel hardware
- Aluminum hydraulic cylinders
- Full length vinyl bunks
- Solar or AC charging options
- Manufactured in New York State
- 15 year limited warranty



Hydraulic Aluminum Lifts

Model #	Weight Capacity	Max. Beam	Lifting Height†	Min. Bunk Height	Shipping Weight	Lifting Speed UP (seconds)	Lifting Speed DOWN	Hydraulic Cylinders	List Price	(assembled) Dock Doctors Price	(un-assembled) Dock Doctors Price
HL20065	2,000 lbs.	65"	48"	24"	235 lbs.	30 sec	20 sec	1	\$ 5,470	\$ 5,063	\$ 4,806
HL40120XL	4,000 lbs.	120"	60"	26"	542 lbs.	65 sec	45 sec	2	\$ 8,250	\$ 7,496	\$ 7,239
HL50120XL	5,000 lbs.	120"	60"	28.5"	680 lbs.	45 sec	45 sec	2	\$ 8,945	\$ 8,105	\$ 7,848
HL70120XL	7,000 lbs.	120"	60"	30"	760 lbs.	90 sec	50 sec	2	\$ 10,005	\$ 9,032	\$ 8,775
HL90120XL	9,000 lbs.	120"	60"	31"	997 lbs.	110 sec	75 sec	4	\$ 13,515	\$ 11,784	\$ 11,527
HL120132XL	12,000 lbs.	132"	60"	40"	1,500 lbs.	80 sec	90 sec	4	\$ 19,150	\$ 16,675	\$ 16,316

*Prices above include (4) 3' legs, battery, AC charger & remote control. For solar power upgrade add \$120 or \$150 for 9k & 12k models. All pricing is F.O.B. our facility in Ferrisburgh, Vermont. Prices are for in stock product only. Additional freight charges may apply for special orders. See page 3 for delivery information.

† Measured from top of bunks to bottom of feet when adjustable legs are fully retracted. Measurements are approximate.

Hydraulic Lift Accessories

Stainless Steel Fitting Upgrades

Cylinders & Hose Assemblies

Lift Model	Upgrade when purchasing new boat lift	Stainless Steel Extension Hoses	
		12'	20'
HL 4K - 6K	\$ 470	\$ 390	\$ 459
HL 7K	\$ 500	\$ 390	\$ 459
HL 9K	\$ 1,350	\$ 390	\$ 459
HL 12K	\$ 2,940	\$ 390	\$ 459

Elevated Power Box Stand

This stand provides protection for your power box from heavy wave action or high water. Aluminum frame provides 15" of height above the deck surface. **\$ 235**

Power box not included in price.



HL Boat Lift Accessories: Guides, Extension Hoses and Extension Legs

Lift Model	Aluminum & Vinyl Guides	Aluminum & Wood Guides	Aluminum Rollers* (for guides)	Standard Ext. Hose 4½' pair	Standard Ext. Hose 12' pair	Standard Ext. Hose 20' pair	Ext. Legs 5' pair	Ext. Legs 7' pair w/ bracing	Ext. Legs 9' pair w/ bracing
3000-4000	\$ 1,095	\$ 1,075	\$ 105	\$ 115	\$ 160	\$ 215	\$ 235	\$ 755	\$ 875
5000-7000	\$ 1,125	\$ 1,115	\$ 105	\$ 115	\$ 160	\$ 215	\$ 235	\$ 755	\$ 875
9000	\$ 1,160	\$ 1,155	\$ 105	\$ 115	\$ 160	\$ 215	\$ 235	\$ 755	\$ 875
12,000	\$ 2,745	n/a	\$ 105	\$ 115	\$ 160	\$ 215	\$ 235	\$ 885	\$ 995

*The aluminum rollers are a recommended option for the aluminum guides. Credit \$160 for 3' legs if upgrading to longer extension legs with the purchase of a new boat lift.



HL Canopies

Size	Price
24' x 124" Canopy	\$ 3,200
26' x 124" Canopy	\$ 3,360
28' x 124" Canopy	\$ 3,655

Note: Prices include standard color Sunbrella® Fabric (Pacific Blue, Cadet Grey & Forest Green). Optional and signature colors are available as a special order (additional cost).

Canopy Leg Kits

Size	Price
4' Canopy Leg Kit with 8' posts	\$ 910
6' Canopy Leg Kit with 8' posts	\$ 1,045
8' Canopy Leg Kit with 8' posts	\$ 1,255

All pricing is F.O.B. our facility in Ferrisburgh, VT. Prices are for in stock product only. Additional freight charges may apply for special orders.

*Ideal for boats from 6,000 to 32,000 lbs, the **Ultimate vertical boat lift** is custom manufactured with industrial quality hot-dipped galvanized steel. This lift can be used in shallow and deep water applications, rough water, and in fluctuating water levels. The 12,000 lb. and larger models are modular for ease of seasonal handling.*



Please note: boat lift shown should be raised higher so entire boat and cradle are out of the water to achieve optimum safety for the boat.

Ultimate VL Boat Lift – by The Dock Doctors

- 6,000 lb. to 32,000 lb. capacity
- 9 ft. standard lift height (other heights available)
- Great for shallow or deep water applications
- High lift for rough water & fluctuating water levels
- Portable/seasonal if necessary - 12,000 lb. & larger models fabricated in modular sections for ease of seasonal handling
- Industrial quality hot dipped galvanized steel construction, stainless steel cables & galvanized fasteners
- Adaptable to boathouses for use with permanent docks
- Custom heights, widths & lengths are available to accommodate your boat & location



12,000 lb. Ultimate vertical boat lift with custom canopy.



12,000 lb. capacity Ultimate vertical boat lift with optional powder coating.



Bolton Landing, NY



Above: 32,000 lb. capacity Ultimate Lift.
Right: Modular section of the above boat lift being loaded for delivery. See information on our delivery services on page 3.





Queensbury, NY

12,000 lb. capacity Ultimate Lift with oil bath drive upgrade.



Sliding Boarding Step: Bridges the gap from your dock to your boat

Remove the gap to transition safely to/from your boat. Securely attaches to your existing dock (see page 12 in the dock accessories section of this catalog).

Dock Doctors® Ultimate Vertical Boat Lifts



Model #	Capacity	# of Drives	Maximum Beam	Lifting Height	Overall Width	Overall Length	Price*
6000	6,000 lbs.	2	8' 6"	9'	11'	12'	\$12,900
9000	9,000 lbs.	2	10'	9'	12'	13'	\$14,500
12000	12,000 lbs.	4	11'	9'	13'	14'	\$21,500
18000	18,000 lbs.	4	12'	9'	14'	16'	\$24,900
24000	24,000 lbs.	4	14'	9'	16'	18'	\$29,500
32000	32,000 lbs.	4	18'	9'	20'	20'	\$33,900
Auto Stop System (recommended option)							\$ 890

Custom sizes are available.

*Prices above include Gem remote control, sealed bearing and grooved cable winders, AC drives, (4) 7' vertical guide poles with PVC sleeves, (4) wheel mounts, (4) 24" adjustable legs and heavy duty carpeted bunks. Optional oil bath drives and full length guide-ons are available. Please inquire for pricing.



We can deliver and install your boat lift.

See page 3 for delivery information.

Boathouse lifts are custom built to be installed in new or existing boathouses. These lifts are designed to accommodate various boat styles, capacities, and in some cases aesthetic appearance.

- Freestanding units for boathouses without structural integrity to support your boat
- Bunk style cradle system with pull-out tubes for winter storage
- Sling style for shallow water applications



Sling style boathouse lifts are ideal for shallow water applications.

Occasionally, protecting your boat requires a product that is designed to fit your individual needs. We can design, fabricate, and install custom canopies, boat lifts and much more to accommodate unique situations. Please contact us for a free quote and conceptual layout.



Above: The Dock Doctors Ultimate Lift (see pages 60-63) customized to attach to the shore with galvanized lift arms which allow it to be raised for winter storage.



Custom powder coated uprights for use with a standard RGC® canopy.

Installation & Removal Services

Let the Waterfront Specialists do it for you!

We provide service to all areas in the Northeast!

*Living in the Northeast often has the added responsibility of removing and installing your dock system every year. Take the worry and hassle away with The Dock Doctors® **seasonal service plan**, and have the assurance that your dock system will be taken care of with the utmost quality and safety in mind.*



Visit our showrooms



A

Vermont Showroom & Manufacturing Facility



A

Vermont Indoor, Year-Round Showroom



Showroom Locations www.thedockdoctors.com

A Vermont Showroom & Manufacturing Facility
19 Little Otter Lane, Route 7, Ferrisburgh, VT 05456

☎ 800-870-6756

OPEN
YEAR-ROUND!

Monday–Friday 9:00–4:30

Saturday 9:00–1:00 (April 8th thru July 29th)

The Vermont showroom (A) is closed Memorial Day and 4th of July weekend.

B Lake Placid/Saranac Showroom

876 State Route 86, Ray Brook, NY

Located midway between Lake Placid & Saranac Lake

☎ 518-354-5011 (seasonal phone only)

Seasonal Hours (June 1st through September 1st)

Tuesday–Friday 10:00–4:30 Saturday 10:00–2:00

The Lake Placid showroom (B) is closed 4th of July weekend.

C Lake George Product Display

No Staff - No Hours - Come by anytime

2963 Lake Shore Drive (Rte 9N), Lake George, NY

Located just off the Adirondack Northway (187) at exit 22



B

Lake Placid Seasonal Showroom



C

Lake George Outdoor Product Display