



*Our **standard duty aluminum frame leg and wheel docks** are designed for protected sites with minimal wave action, feature an exceptionally strong aluminum frame. These strong yet lightweight docks are easy to assemble and can be installed by one person.*



Complete our **site survey** on our website and we will send you a free quote and conceptual layout customized to your property.
www.thedockdoctors.com/site-survey



Lake Groton, Groton, VT

Standard Duty Aluminum Leg & Wheel Docks

- Exceptionally strong aluminum frame
- Support stanchions built into the frame, for an obstruction-free dock edge
- Removable decking in cedar, aluminum, NyloDeck® composite® - or attached Sure-Step® decking
- Optional powder-coated frame



EASY one person install

Our innovative connector clips and lightweight sections allow for one person to easily connect sections together and install the dock system.

Wheel docks easily roll in and out as the water fluctuates during the season.



Standard duty aluminum wheel docks with cedar decking and optional dock mounted roller.

Dock mounted roller
(see page 13)

See pp. 48-52 for more information on our small craft launch systems.



Standard duty aluminum leg dock with Sure-Step® decking and our freestanding launch port system
(see page 49).



Standard duty aluminum docks used to create a shoreside deck area.



Single craft storage arms (see page 13)



4' x 8' Leg Dock



4' x 12' Wheel Dock



Standard Duty Aluminum

see decking details on p. 15

Size	Weight*			 <small>see color choices on p. 15</small>	
		Price	Price	Price	Price
LEG DOCKS					
4' x 8'	49 lbs.	\$ 549	\$ 759	\$ 865	n/a
4' x 10'	63 lbs.	\$ 629	\$ 879	\$ 1,019	n/a
4'3" x 8'5"	99 lbs.	n/a	n/a	n/a	\$ 729
4' 3" x 10' 5"	125 lbs.	n/a	n/a	n/a	\$ 839
WHEEL DOCKS					
4' x 12'	95 lbs.	\$ 1,055	\$ 1,349	\$ 1,495	n/a
4' 3" x 12' 5"	149 lbs.	n/a	n/a	n/a	\$ 1,309

Dock pricing includes frame and removable decking. Wheel dock pricing includes (1) pair of wheels and axle assembly. The necessary assembly components are sold separately.

*Weights for docks with cedar, NyloDeck® or aluminum decking do not include the decking. Sure-Step® decking attaches directly to the dock frame and is not removable. Please allow additional order time for powder coated frame upgrade.



Assembly Components



Connector Clips
for connecting docks
together
\$ 23.⁰⁰ set of 2



Safety Cap
for 1 1/2" pipe
\$ 4.⁹⁵ each

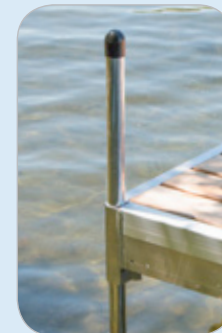

Aluminum
Pipe 1 1/2"
cut to length pending
water depth
\$ 6.⁹⁵ / foot



Footpad
(aluminum)
\$ 32.⁰⁰ each



Cross Braces
(optional)
stabilizes docks in
deeper water
\$ 137.⁰⁰



Our **medium duty aluminum frame leg and wheel docks** offer superior strength and stability, featuring taller frames and longer and wider sections than our standard duty frames. Easy to assemble and install, the support stanchions are built into the frame and flush to the sides of the dock, allowing for an obstruction-free dock edge.



Medium Duty Aluminum Leg & Wheel Docks

- Exceptionally strong, 7" tall aluminum frame
- Support stanchions built into the frame for an obstruction-free dock edge
- Removable cedar, NyloDeck® composite or aluminum decking panels
- Optional powder-coated frame
- Trex® decking also available



EASY assembly & installation

No sharp edges on underside of frames make our aluminum docks easy on the hands for carrying.

Complete our **site survey** on our website and we will send you a free quote and conceptual layout customized to your property.
www.thedockdoctors.com/site-survey



Medium duty aluminum leg docks with NyloDeck® decking.



Medium duty aluminum leg docks with aluminum decking. Accessed by our adjustable aluminum stairs (see pages 42-43).



Dock sections installed side by side to create an "L" shape with optional triangle section for more deck space.

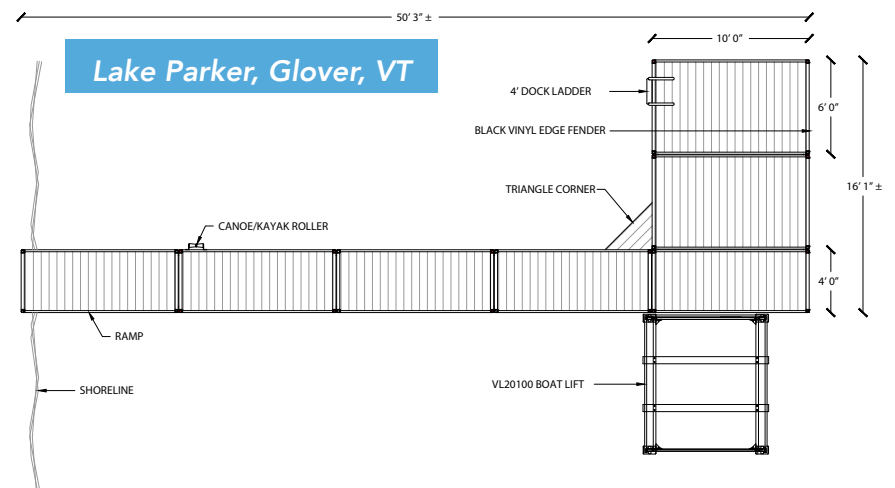

Visualize any of these designs for your property:
 Arrange in a variety of layouts to suit your site and individual needs.



Silver Lake, NY



Medium duty aluminum leg docks with cedar decking, aluminum ladder (see page 8) and pipe-mounted flagpole (see page 14).



***EASILY* adjust height**

Easily adjust the height using our winch adjustment kit (sold separately on page 18).



Medium duty aluminum leg docks with shallow water stairs (see p. 8) and kayak/canoe roller (see p. 13).



Washington, NH



Medium duty aluminum leg docks with NyloDeck® decking at a town beach in Washington, NH.



Accessory Ideas: see pages 8-19 for full details and more accessory options



shallow water stairs



solar lighting



dock-mounted roller



6' x 8' Leg Dock



4' x 16' Wheel Dock



Assembly Components



Connector Clips
for connecting docks together
\$ 33.00 set of 2



Safety Cap
for 1 1/2" pipe
\$ 4.95 each



Aluminum Pipe 1 1/2"
cut to length pending water depth
\$ 6.95 / foot



Footpad (aluminum)
\$ 32.00 each



Cross Braces (optional)
stabilizes docks in deeper water
\$ 137.00 (4' wide docks)
\$ 147.00 (6' wide docks)

Medium Duty Aluminum

see decking details on p. 15

Size	Weight*	see color choices on p. 15		
		CEDAR Price	ALUMINUM Price	NYLODECK® Price
LEG DOCKS				
4' x 8'	71 lbs.	\$ 695	\$ 909	\$ 1,009
4' x 10'	85 lbs.	\$ 799	\$ 1,045	\$ 1,167
4' x 12'	100 lbs.	\$ 889	\$ 1,185	\$ 1,339
6' x 8'	89 lbs.	\$ 899	\$ 1,199	\$ 1,359
6' x 10'	107 lbs.	\$ 1,035	\$ 1,409	\$ 1,629
6' x 12'	125 lbs.	\$ 1,159	\$ 1,629	\$ 1,875
3' x 3' Triangle Corner	30 lbs.	\$ 399	\$ 465	\$ 499
WHEEL DOCKS				
4' x 16'	129 lbs.	\$ 1,569	\$ 1,975	\$ 2,199
6' x 16'	161 lbs.	\$ 1,779	\$ 2,389	\$ 2,715

Dock pricing includes frame and removable decking. Wheel dock pricing includes (1) pair of wheels and axle assembly. The necessary assembly components are sold separately. *Weights for docks do not include the decking. Trex® decking also available as a special order. Please allow additional order time for powder coated frame upgrade.





Designed for exposed sites and rough water conditions, our **heavy duty steel truss leg and wheel docks** are incomparable for strength and durability. The heavy duty steel truss frame allows water to pass through the frame.





Steel truss leg docks used to transition over a rocky shoreline.



Heavy duty steel truss dock with 6' x 10' sections and cedar decking.

Heavy Duty Steel Truss Leg & Wheel Docks

- Heavy duty 9" galvanized steel truss frame
- Designed for exposed sites
- Adjustable leg stanchions built into frame
- Removable decking in cedar or NyloDeck® composite (*Trex® or Ipe hardwood decking also available*)
- Optional powder-coated frame
- 10 year limited warranty



6' wide sections optimize dock space for all your activities - shown with optional cedar post covers (see page 14).



Lake Champlain, Plattsburgh, NY

6' wide wheel dock with 4' x 8' "L" section and 2' x 10' catwalk.



EASY to install

Install yourself, or use our seasonal installation and removal service (see inside back cover for more details).

Accessory Ideas: see pages 8-19 for full details and more accessory options

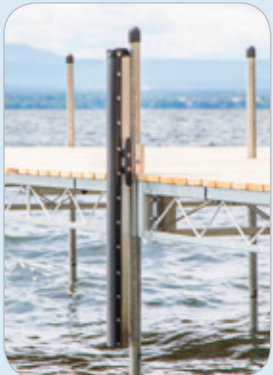

vertical fender



lower access platform shown with aluminum ladder



6' wide heavy duty steel truss leg docks with cedar decking and our pipe-mounted vertical fenders (see page 10).



4' x 10' Leg Dock



4' x 16' Wheel Dock



Heavy Duty Steel Truss

see decking details on p. 15

Size

Weight*

CEDAR

Price

see color choices on p. 15

NYLODECK®

Price

LEG DOCKS

4' x 8'	100 lbs.	\$ 799	\$ 1,105
4' x 10'	115 lbs.	\$ 859	\$ 1,229
6' x 8'	125 lbs.	\$ 1,035	\$ 1,395
6' x 10'	150 lbs.	\$ 1,095	\$ 1,679
2' x 10' Catwalk (std duty)	75 lbs.	\$ 459	\$ 675
3' x 3' x 4' Triangle Corner	45 lbs.	\$ 279	\$ 365

WHEEL DOCKS

4' x 16'	208 lbs.	\$ 1,699	\$ 2,315
6' x 16'	230 lbs.	\$ 1,925	\$ 2,829
4' x 16' with 4' x 8' L	328 lbs.	\$ 2,510	\$ 3,429
6' x 16' with 4' x 8' L	350 lbs.	\$ 2,735	\$ 3,975

 Ipe hardwood &  Trex® composite decking also available as a special order.

Dock pricing includes frame and removable decking. Wheel dock pricing includes (1) pair of wheels and axle assembly. The necessary assembly components are sold separately. *Weights for docks do not include the decking. Please allow additional order time for powder coated frame upgrade.



Assembly Components



Connecting Brackets
each connection requires (4)

End-to-end: \$12.⁵⁰ ea

Side-by-side: \$12.⁵⁰ ea

Catwalk (3"): \$10.⁵⁰ ea
catwalk requires (2) 3" brackets & (2) truss end-to-end brackets



Safety Cap
for 1 1/2" pipe

\$ 4.⁹⁵ each

Galvanized Pipe

1 1/2" cut to length
pending water depth

\$ 6.⁹⁵ / foot



Footpad
(galvanized steel)

\$ 34.⁰⁰ each



Dock Panel Securing Cord

\$ 4.⁹⁵ set of 4



Cross Braces

(optional) stabilizes
docks in deeper water

\$ 137.⁰⁰ (4' wide docks)

\$ 147.⁰⁰ (6' wide docks)



Designed for use in rough and deep water applications, our **mega duty steel truss leg and wheel docks** feature taller frames, longer and wider sections, and larger diameter upright supports. Available in two stock sizes (or contact us for custom size dock options).



Lake George, NY

Mega Duty Steel Truss Leg & Wheel Docks

- Designed for use in rough & deep water applications
- 11" tall galvanized steel truss frame
- 3" diameter upright supports
- Stocked in 6' × 20' & 8' × 20' sizes (custom sizes available)
- Adjustable leg stanchions built into frame
- Removable cedar or NyloDeck® composite decking panels (Trex® or Ipe hardwood also available)



Mega dock with NyloDeck® decking, aluminum gangway (see p. 41) and our ultimate boat lift with Sunbrella® canopy (see pages 60-63).



6' × 20' mega duty steel truss dock with a 4' × 16' heavy duty ramp section to transition over rocky shoreline.



6' x 20' mega duty steel truss docks with 3' x 24' aluminum gangway, (2) 1,250 vertical PWC lifts, and our 6,000 lb. Ultimate boat lift.

Heavy Duty vs. Mega Duty Frames

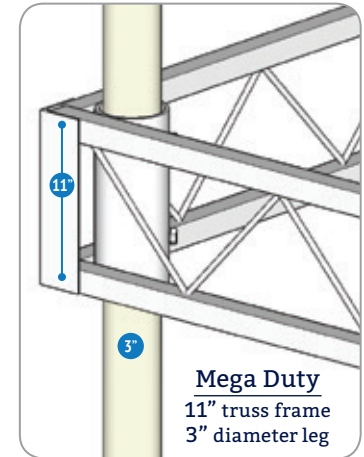
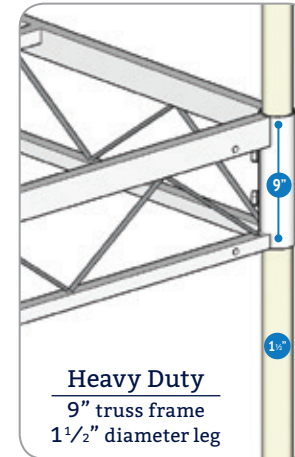

Accessory Ideas: see pages 8-19 for full details and more accessory options



aluminum ladder



boarding handle



flag pole

protect your boat
with our adjustable
vertical fenders

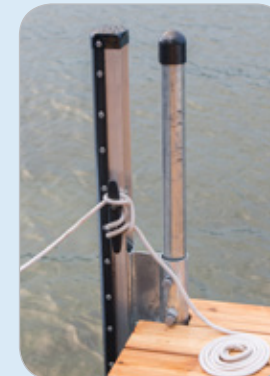

vertical fender



mooring whips



Shelburne, VT

Our mega dock used as shoreside access to a custom floating dock (see our Custom Catalog).

Mega Duty Steel Truss

see decking details on p. 15

Size Weight*

LEG DOCKS

Size	Weight*	CEDAR Price	NYLODECK® Price
6' x 20'	400 lbs.	\$ 3,569	\$ 4,719
8' x 20'	480 lbs.	\$ 4,769	\$ 6,269

WHEEL KITS

for 6' wide docks	\$ 439
for 8' wide docks	\$ 459

Ipe hardwood & Trex® composite decking also available as a special order.

Pricing includes dock frame and removable decking. Custom sizes available as a special order. Wheel kits sold separately (see above). The necessary assembly components are sold separately. *Weights do not include the decking. Please call for pricing on custom upgrades. Please allow additional order time for powder coated frame upgrade.

see color choices on p. 15



Assembly Components



Connecting Brackets
each connection requires (4)
\$ 24.⁰⁰ each



Safety Cap for 3" pipe
\$ 6.⁵⁰ each
Galvanized Pipe 3"
cut to length pending water depth
\$ 12.⁹⁵ / foot



Footpad for 3" pipe
(galvanized steel)
\$ 47.⁰⁰ each

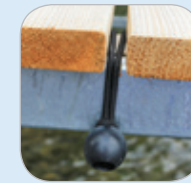

Dock Panel
Securing Cord
\$ 4.⁹⁵ set of 4



Cross Braces (not shown)
(optional) stabilizes
docks in deeper water
\$ 168.⁰⁰ (6' wide docks)
\$ 178.⁰⁰ (8' wide docks)



Mega Dock
Adjustment Kit
Adjust the level of your dock
with this kit that slides over
the 3" leg pipe.
\$ 419 / pair